

Table Of Contents

PART ONE: HISTORICAL BACKGROUND, DESCRIPTION, OPERATION, GENERAL DISASSEMBLY & ROUTINE MAINTENANCE	1
I. HISTORICAL BACKGROUND	3
II. DESCRIPTION AND OPERATION	
Section 1, Description	11
Section 2, Operation	12
Section 3, Ammunition	19
Section 4, Use with Grenade Launchers	20
Section 5, Bayonets	25
III. FUNCTIONING, STOPPAGES AND IMMEDIATE ACTION	29
Section 1, Functioning	29
Section 2, Stoppages and Immediate Action	30
IV. FIELD STRIPPING, CLEANING & ROUTINE MAINTENANCE	33
Section 1, Field Stripping	33
Section 2, Cleaning	44
Section 3, Routine Maintenance	44
PART TWO: INSPECTION, COMPLETE DISASSEMBLY AND DETAIL REPAIR	47
V. INSPECTION	49
Section 1, Inspection Prior to Disassembly	49
VI. TOOLS, GAGES AND FIXTURES	53
Section 1, General	53
Section 2, Non-Improved Tools, Gages, Etc.	53
Section 3, Improved Tools, Gages, Etc.	55
VII. GENERAL MAINTENANCE	59
Section 1, General	59
VIII. BARREL AND RECEIVER GROUP	61
Section 1, Disassembly	61
Section 2, Inspection	62
Section 3, Maintenance and Repair	67
Section 4, Assembly	73
IX. TRIGGER HOUSING GROUP	75
Section 1, Disassembly	75

Section 2, Inspection	75
Section 3, Maintenance and Repair	76
Section 4, Assembly	77
X. STOCK AND HAND GUARDS	79
Section 1, Disassembly	79
Section 2, Inspection	79
Section 3, Maintenance and Repair	79
XI. EQUIPMENT	83
Section 1, Bayonets	83
Section 2, Slings	83
Section 3, Grenade Launchers	83
Section 4, Flash Hider	83
XII. FUNCTION FIRING AND FINAL INSPECTION	85
Section 1, Function Firing	85
Section 2, Final Inspection	85
XIII. MODIFIED GARANDS	87
Section 1, The BM-59 Series	87
Section 2, The "M2" or "M14 Garand"	87
Section 3, U.S. Rifles 7.62mm, M14 & M14E2	89
Section 4, Improvised Bipod for Garand	92



I. Historical Background

When screaming Stukas tore open the skies over Poland on September 1, 1939, and ushered the major powers of Europe into what would ultimately be global warfare, the United States was the only major military power to have a semi-automatic rifle as standard military issue, and even then there were only about 50,000 Garands actually issued to troops. All other participants still armed their troops with the tried and proven bolt action, even though France, Germany and Imperial Russia had used semi-auto rifles to some extent during World War I.

To understand such thinking, it is necessary to take a brief look at military arms development over the centuries. The earliest practical, hand-held firearms were matchlocks, in which a piece of smoldering cord or rope was attached to the hammer. When the trigger was pulled, the hammer would fall and sparks from this "match" would come in contact with the priming powder, thus igniting the powder charge in the breech end of the barrel, driving the ball out of the barrel and toward its target. These snapping matchlocks first appeared around 1470. In earlier versions, the "match" was actually applied to the touch hole by hand.

Leonardo da Vinci first illustrated the wheel-lock mechanism around 1500, and it was considered such an awesome weapon that it was banned within the Holy Roman Empire in 1518. Although vastly more efficient than the matchlock, it was very complicated and expensive to produce. The first true flintlocks appeared a little less than 100 years later, around 1610. While the flintlock was demonstrably the most efficient form of ignition developed up to that time, the matchlock

didn't fall into disuse in Europe until around 1700. Although obsolete in both theory and fact long before that, the matchlock didn't become obsolete in actual use until that time since large numbers of matchlock muskets were already in service. Then, just as today, the guardian of the royal checkbook was reluctant to discard weapons which could still be used, even if they weren't the latest development.

Such reluctance to change carried over well into the 19th and even the 20th centuries. The percussion cap was patented in 1807, yet this superior ignition system didn't become standard in the United States and Europe until the 1840's. Even though the first successful self-contained metallic cartridges appeared in the 1850's, most of the Civil War was fought with muzzleloading rifles and muskets and cap and ball revolvers, most of which were made *during* the war, *after* the obsolescence of muzzleloaders. A few breechloading repeaters such as the Spencer, saw service in the conflict, but the true value of repeating rifles in battle wasn't proven until 1877.

Low budget Western movies or TV shows often show U.S. Cavalry armed with lever action Winchesters (always the ubiquitous M1894, of course). This is a totally erroneous picture, as the official U.S. rifles and carbines of the post-Civil War era were single shot .45-70 "trap door" Springfields, with a few Spencer .56's still in service. Although they have appeared in the hands of guerrillas virtually all over the world, lever action Winchesters have been used only sparingly as official military weapons, and then solely in Europe. However, their first such use was to alter the art of warfare forever. At the battle of Plevna, in what is

THE FIGHTING GARAND

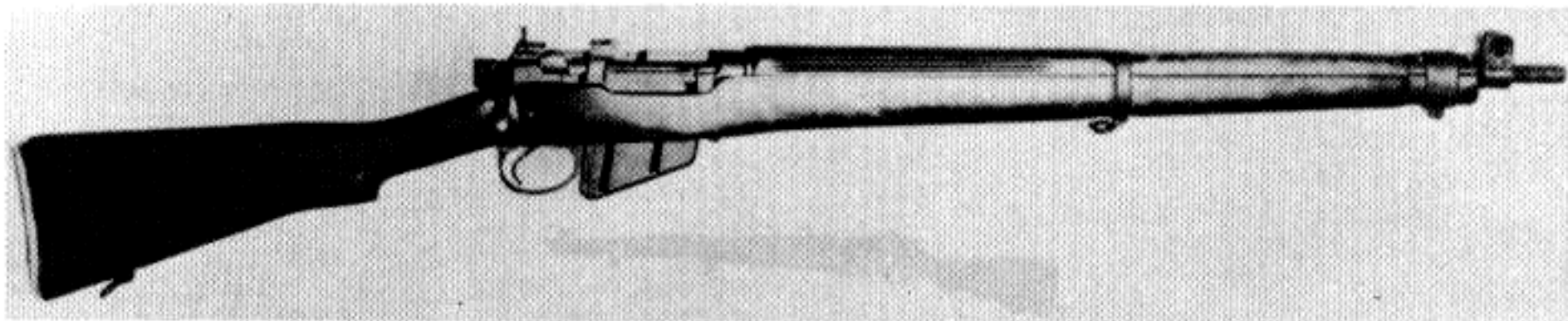

British No. 4 Mk. I Lee Enfield was typical of the bolt action rifles with which most belligerents entered World War II. Virtually all were direct descendants of weapons developed prior to the turn of the century. Only the United States entered the war with a semi-automatic rifle as standard issue. Even then, many troops were still armed with the M1903 Springfield.

now Bulgaria, an overly confident Imperial Russian Army attempted to storm the Turkish position with their single shot rifles in the summer of 1877. The Turks were armed with M1866 Winchesters, and proceeded to annihilate the Russian forces. When the Russians decided to try a re-run of the same battle at the same place six weeks later, the results were the same. All in all, the Russians lost 30,000 men in the two debacles at Plevna.

Word of the Russian defeat spread like wild-fire across Europe, and the race for repeating arms was on. Within a comparatively short time for the military (a few years), virtually every continental army had adopted a bolt action repeating rifle. Even the United States had at least examined some dozen bolt actions in the 1872 ordnance test, but had decided to stay with the .45-70 Springfield.

With the introduction of the French 8mm Lebel smokeless cartridge in 1886, the trend toward smaller bore military arms was made possible. By the end of the century, it was pretty well established that a .30 caliber cartridge was the most efficient compromise for military use. The advent of smokeless powder also meant that truly successful semi-auto rifles and pistols could be devel-

oped, arms which previously would have become fouled by black powder residue after only limited firing.

That great machine gun inventor, Hiram S. Maxim, had actually come up with a sound design for a semi-auto rifle as early as 1881, but turning a sound design into a military reality can often be a frustrating experience, as arms designers throughout America and Europe were discovering. Von Mannlicher produced numerous semi-auto rifle designs in Austria in the 1890's, at least a couple of which were imminently practical. While John M. Browning toyed with semi-auto rifle designs in America, a Major Cei-Rigotti was busy inventing a gas-operated semi-automatic rifle which had a port in the barrel and a tappet system for operating the bolt. Although his design didn't cause much of a stir in 1900, it was widely copied by both the Germans and the Soviets when they finally got into the swing of semi-auto rifle production late in World War II.

A study of the history of Europe during the 19th Century reveals that war was almost a perpetual state of being somewhere on the continent during that turbulent era, so it's little wonder



U.S. M1 Garand was the first semi-automatic military rifle to see service as standard issue. Adopted in 1936, it was America's main battle rifle until the late 1950s, saw extensive service in both World War II and Korea. Many still consider it the best battle rifle ever made.

THE FIGHTING GARAND

that European armies were generally equipped with the latest in *proven* weapons designs, meaning, of course, bolt action, magazine-fed rifles. America, on the other hand, had been involved in only two wars with foreign powers between 1800 and 1898. The Civil War was, despite the record casualties unparalleled in American military history, strictly an internal affair in which both sides were about equal in actual quality and modernity of arms. It is little wonder, then, that we were slow in getting onto the bolt action bandwagon. When we entered the Spanish-American War in 1898, only the 27,000 man Regular Army was equipped with Krag-Jorgensen .30-40 bolt action rifles. State militia units were mostly armed with the old .45-70 Springfield. The superiority of the German Mauser (both rifle and cartridge) was proven at the Battle of San Juan Hill, where a garrison of 700 Spanish soldiers inflicted heavy casualties on the American force of 15,000, accompanied by Cuban insurgents.

The War Department finally realized that the Krag-Jorgensen just wasn't good enough, so in 1900 a new .30 caliber bolt action rifle was produced by Springfield Armory. Its cartridge was little better than the .30-40 Krag, so further development produced the M1903 Springfield and the famous .30-06 cartridge.

As we mentioned earlier, there were small wars going on somewhere in Europe throughout the 19th Century, and things hadn't improved much as the world entered the 20th Century. There were actually two Balkan Wars immediately preceding World War I. France continued to nurse a strong distrust of Germany from the previous century and was constantly looking for better arms. Despite the almost universal acceptance of the bolt action rifle for military use, the French tested some 15 semi-auto rifle designs between 1897 and 1911, for an average of slightly more than one new design per year. The STA8 was actually adopted in 1910, with production beginning in 1913. As with most changes in military small arms, the STA8 couldn't be issued to all troops virtually overnight, so the bolt action Lebel was still standard issue when a disgruntled Bosnian student decided to use Archduke Francis Ferdinand for target practice in Sarajevo in June 1914. Within weeks, all of Europe was caught up in "the war to end all wars" and production of the STA8 was terminated in favor of the Lebel, which was a known quantity.

Early in the war, some German ground troops and aircraft observers were armed with Mondragon semi-auto rifles, an interesting anomaly to say the least. Designed by a Mexican general of the same

name, the Mondragon was briefly manufactured in Switzerland before the war and saw service with only one army, the Kaiser's. It proved not to be rugged enough for battlefield use and was soon phased out in favor of the tried and true M98 Mauser.

Imperial Russia introduced the Federov M1916 "avtomat", which could actually be called the forerunner of today's assault rifles since it was a select fire arm chambered for, of all things, the 6.5mm Japanese round. Like the Mondragon and the French St. Etienne M1917, it proved less than ideal in actual combat.

World War I was so much larger in scope and in number of troops fielded than any previous war that virtually every participant, including the United States, had to issue an odd assortment of rifles in addition to the standard issue arm. But at least the U.S. was standardized in caliber. When America entered the war in 1917, both Remington and Winchester were tooled up to produce the British Pattern 14 in .303 British. The design was quickly rechambered in .30-06 to become the famous M1917 Enfield. Although extremely heavy and not as well designed as the Springfield, the M1917 Enfield was a rugged, reliable arm as Sgt. Alvin York and a host of other doughboys (far more of whom were armed with the M1917 Enfield than with the Springfield) would prove.

An attempt was made during the war to turn the Springfield into a semi-auto rifle by adapting it to take what was known as the Pederson device. With the bolt removed, this device could be fitted to the Springfield so that it would fire a round similar to the .32 ACP in a semi-auto mode. Although 65,000 of the contraptions were made, it proved impractical in actual combat. The Pederson device was actually a stopgap attempt to increase the Springfield's rate of fire to counter the new German submachine guns which were beginning to appear at the front. As ridiculous as the idea sounds today, it was a sincere and honest attempt to solve a very real problem.

With the end of hostilities in 1918, the world returned to an uneasy peace. Semi-automatic military rifle development continued in a number of countries with varying degrees of success, mostly varying degrees of mediocrity.

A new .276 cartridge was developed by the same man who had developed the Pederson device and was nearly adopted as the official U.S. rifle cartridge. During the 1929 ordnance tests at Aberdeen Proving Ground, every rifle tested with the exception of the Garand was chambered for this

THE FIGHTING GARAND



From Lexington and Concord to Omaha Beach in Normandy and the steamy sands of Iwo Jima or the bitter cold of Pork Chop Hill and Heartbreak Ridge, the Infantryman's best friend has always been his rifle. Millions of American troops relied on the Garand as that friend through one global war and a "police action" in Korea that was, for all practical purposes, a full scale war. Here a Garand-toting GI breaks from cover and advances on a Pacific beachhead during World War II.

round. The Garand was chambered for the standard .30-06 cartridge. John C. Garand had submitted an excellent design for testing in 1920, its only drawback being that it required special ammunition to make it work. After it was rejected outright for that very reason, Garand realized that he would have to come up with a rifle that would function well with existing arsenal ammo. Happily, his 1929 rifle did just that and it was adopted for service, receiving official adoption in 1936. Fortunately for the U.S. and her allies, Chief of Staff Gen. Douglas MacArthur disapproved of the .276 round for which the Garand was supposed to be chambered when production began, so the U.S. M1 rifle was manufactured in .30-06, an important logistic detail during the war when U.S. troops carried not only the Garand, but the Springfield and 1917 Enfield as well.

At the outbreak of World War II, virtually every Allied and Axis power with exception of the United States was essentially armed with rifles that dated from the preceding century, at least in terms of caliber and general type if not in actual date of manufacture.

On the Allied side, the British were armed with SMLE's, mostly No. 4 Mk I rifles once the war got into full swing. For the Home Guard, they had a motley collection of Rosses, M1903 Springfields and M1917 Enfields. As invasion appeared imminent, the cry of "Send A Gun To Defend A British Home" was heard throughout America. Rifles, shotguns and handguns of virtually every imaginable description were donated to the cause. While the fact that America was sending guns to arm the British populace was undoubtedly known to Hitler,



Although it still lives on in commercial models produced by Springfield Armory, the Garand will always be thought of primarily as the rifle which helped widen the crack in the seemingly impregnable wall of Fortress Europe. While strategic bombing (a new concept in the 1940s) was a major factor in winning the war, the individual foot soldier was still the most important weapon in the Allies' arsenal. Even with today's nuclear, particle beam and laser technology, virtually every nation that has an army maintains a large infantry.

THE FIGHTING GARAND

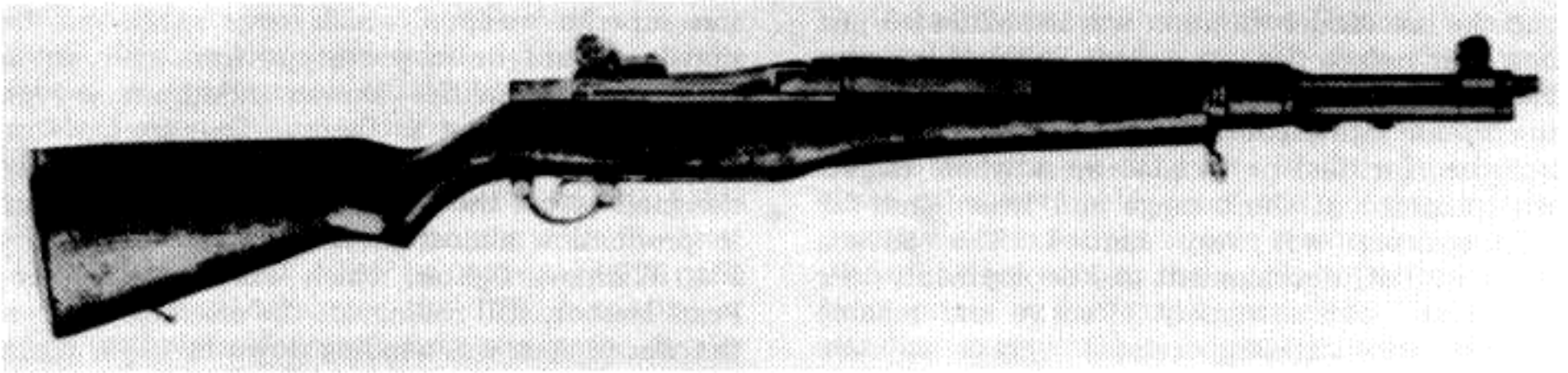

A shortened Garand, the T-26, was designed for use in Pacific jungle fighting. However, the war ended before it could be put into service and only a few were made. The concept lives on today in Springfield Armory's Tanker Garand.

it certainly wasn't the main reason he decided not to invade the British Isles. However, one can bet that he well knew what his troops would be facing if they did invade. A thoroughly armed and determined populace could have easily made the position of Nazi occupation troops untenable, if indeed they had ever been able to occupy the British Isles at all.

The primary French rifle was the MAS 1936, although as the Maginot Line proved worse than useless and the tides of war swiftly turned against

France ancient 8mm Lebel's, some dating back as far as the M1886, and other leftovers from the first war were rechambered to the new 7.5mm French round. After France fell, the U.S. armed Free French forces with the M1903 and M1917 rifles in the standard U.S. .30-06 caliber.

The Mosin-Nagant was still the primary rifle of the Soviet Union, especially the M1938 variation. Even after the superiority of autoloaders had been firmly established by the M1 Garand and M1 Carbine, the Mosin-Nagant continued in production



Following World War II, the Italian Army adopted the Garand. Made under license by Beretta, it was soon modified to take the 7.62mm NATO cartridge and was fed from a 20-round box magazine. This new rifle was designated the BM-59. It has been produced in a number of variations, including select fire models. A BM-59E is shown at top, over a rare 7.62mm NATO Italian Garand.

THE FIGHTING GARAND

and the last model variation was the M1944 — just one year before the war ended! Submachine guns had by then, of course, proven most effective in the intense fighting around Stalingrad and in other built up, fortified or wooded areas where targets were engaged at short range and when time for sighting/firing was very limited. The Soviets shone in SMG development and deployment, their very crude but extremely effective and reliable PPSH-41 being a sterling example.

On the Axis side, German riflemen were primarily armed with one of the M98 Mauser variants, and this continued to be true throughout the war, although some elite paratrooper units were armed with the very interesting FG-42 later in the war. This rifle was a select fire weapon which fired from a closed bolt as a semi-auto and from an open bolt when set for full auto — and it actually worked. The Allies first encountered this weapon in the fierce fighting to take Monte Cassino in Italy in 1944.

One who has never been on the inside in the initial planning, design work, then prototype and finally production stages of an item might well ask, "If the FG-42 was so good, why didn't Germany simply stop making the Mauser and go with the FG-42 exclusively?" For that matter, they could also ask why U.S. arsenals turned out so many M1903A3's during the war when the Garand had been adopted in 1936.

The simple fact of the matter is that peacetime military budgets are normally very lean. This may sound strange when one considers the \$200 billion plus military budgets of the U.S. during the 1980's (the *total* direct cost to the U.S. for World War II was \$330 billion). However, such large defense budgets (in inflated dollars at that) in peacetime have only come about since the Cold War of the 1950's. The U.S. military budgets of the 1930's were pathetic in light of the buildup that would be necessary in just a few short years. At the time Pearl Harbor was attacked, only about 50,000 Garands were actually in the hands of U.S. troops. The 50,000 plane Air Corps that President Franklin Delano Roosevelt had promised didn't exist. P-38's flying patrol duty along the Pacific Coast in the closing days of 1941 were unarmed, but sported broom handles painted black to simulate machine guns in their noses.

Another unalterable fact is that in the exigencies of wartime conditions, when there is a shortage of weapons of all types, an obsolete weapon of proven reliability and for which tooling and assembly lines already exist is vastly preferable to

the superior weapon which only exists on the drawing board or in prototype form and whose performance qualities are an unknown, though they be near-perfect in theory. Thus we have the examples of the M98 Mauser which was actually designed before the turn of the century remaining in production almost until war's end and of the P-40 Warhawk fighter, which was obsolete before Pearl Harbor, still rolling off the assembly lines as the war in Asia was winding down in 1945. When war was declared, we needed planes and rifles badly, so the P-40 remained in production even after the excellent P-51 Mustang was available in quantity and the M1903A3 Springfield went back into production for the simple reason that there was already ample tooling available for it and the United States desperately needed more rifles in 1944. In fact, nearly 40,000 Springfields were built between March 1937 and October 1939, *before* war was declared and *after* the Garand had been adopted.

Both Italy and Japan were in the midst of changing rifle calibers when war broke out, the latter actually had *four* rifle calibers listed as "standard" for machine guns at the start of the war. The 6.5mm Arisaka dated from 1897, with the Type 38 rifle very similar in action to that old workhorse of countless armies, the M98 Mauser. Japan adopted the Type 99 rifle in mid-1939, but like any other country with more than a handful of troops, was unable to complete a changeover of rifle and caliber overnight. However, just changing rifles and calibers at all, let alone action types, might be considered real progress in light of the fact that the Portuguese introduced firearms to Japan in the 1500's in the form of matchlocks, and that remained the principle lock type of Japanese weapons until the 1860's!

Italy had a wide variety of rifles in service during World War II, principally 6.5mm M1891 Mannlicher Carcanos, M1889 and M1895 Mannlichers, and a lot of arms captured from the Central Powers during World War I. As usual, the effects of limited military spending during peacetime could be seen in Italian armament. The semi-auto Scotti Brescia Model X of 1931 saw only limited use during the war, even though it was probably superior to any of the bolt actions that were used.

While it would be sheer folly to claim that the Allies won the war simply because American troops were armed with the M1 Garand, the fact remains that it was *the* most outstanding battle rifle of the war. However, the U.S. Army began

THE FIGHTING GARAND

looking for a select fire .30 caliber rifle in early 1944. This request was evidently based on the success of the German FG-42, since it called for a select fire weapon which would fire from an open bolt in full auto and from a closed bolt in semi-auto. The request also called for a detachable 20 round box magazine. Beginning with the basic Garand, Springfield came up with the T20 rifle and Remington developed the T22. A number of other variations followed over the years, finally culminating in the T44, which was the first of the prototypes that led directly to the M14.

One might think that with a new, select fire battle rifle being under development even before the close of World War II, it might have been ready for service during the Korean War. But such was not the case. The mainstays of our troops there remained the Garand and the M1 Carbine. The Garand again upheld its reputation for ruggedness, reliability and accuracy in this conflict. It remained the standard U.S. service rifle until the M14 was adopted in the late 1950's.

Well over 4 million military Garands were made, with some 600,000 being made by Springfield, International Harvester and Harrington & Richardson following the war. The Italian government adopted the Garand in the postwar era, and it was made under license by both Breda and Beretta. The Italians eventually developed the Garand into the excellent BM-59, a 7.62mm NATO rifle with a 20 round detachable box magazine. The BM-59 has been issued in a number of different models, both semi-auto only and select fire. They will be treated with more detail in Chapter 13.

As with most military rifles, Garands began to appear on the surplus market once they were declared obsolete. In the early 1960's, some surplus dealers were selling them for as little as \$29.95 for the select grade. While a number of these rifles were sold, there was no great rush to purchase them for the simple reason they were so plentiful. However, as the supply began to dry up, both prices and demand increased. Really outstanding examples had become collector's items, and the survival movement which had recently begun was placing an emphasis on military and paramilitary type weapons. The Garand went the way of the Luger and the Broomhandle Mauser — unavailable except at a premium price.

With the supply of surplus Garands being all but exhausted and the demand constantly growing, it became commercially feasible to put it back into production. Springfield Armory began producing it in both .30-06 and 7.62mm NATO (.308 Winchester) during the early 1980's, and it has sold well in both calibers. While the sales figures are undoubtedly heartening to the Springfield accountants, they also reflect another fact: even though ordnance experts may declare a certain weapon to be obsolete (and it might actually be from their point of view), discerning shooters recognize greatness, no matter what its age. John C. Garand would be proud to know that the rifle that bears his name shows no signs of losing its popularity, and if anything is more in demand than ever.

Garand lovers can rest assured that the rifle, in either original form or one of its descendants, will be around for a long, long time.



II. Description & Operation

Section 1, Description

1. Characteristics: the U.S. Rifles cal. .30 M1, M1C and M1D are gas-operated, clip-loading, air-cooled, semi-automatic shoulder weapons. These rifles may be equipped with the gun sling M1907 (leather) or M1 (webbing). When desired, grenade launchers M7, M7A1, M7A2, M7A3; bayonets M1, M5, M5-1, or flash hiders M2 or T-37 may be used with these rifles. The flash hider T-37 is issued only for rifles M1C and M1D, and replaces the gas cylinder lock, becoming an integral part of the gas cylinder assembly.

2. Differences between models:

(a) The U.S. Rifles .30 M1, M1C and M1D are basically the same. However, rifles of early manufacture of the same model may differ somewhat due to changes in the design of some of the component parts.

(b) The U.S. Rifle M1 (Fig. 1) is the standard rifle, the basic weapon of the U.S. Infantryman in WWII and Korea (since replaced in service by the M14, then the M16).

(c) The U.S. Rifle M1C (Fig. 2) is the standard M1 rifle with telescopes M81, M82 or M84 mounted on the receiver, and a cheek pad screwed to the

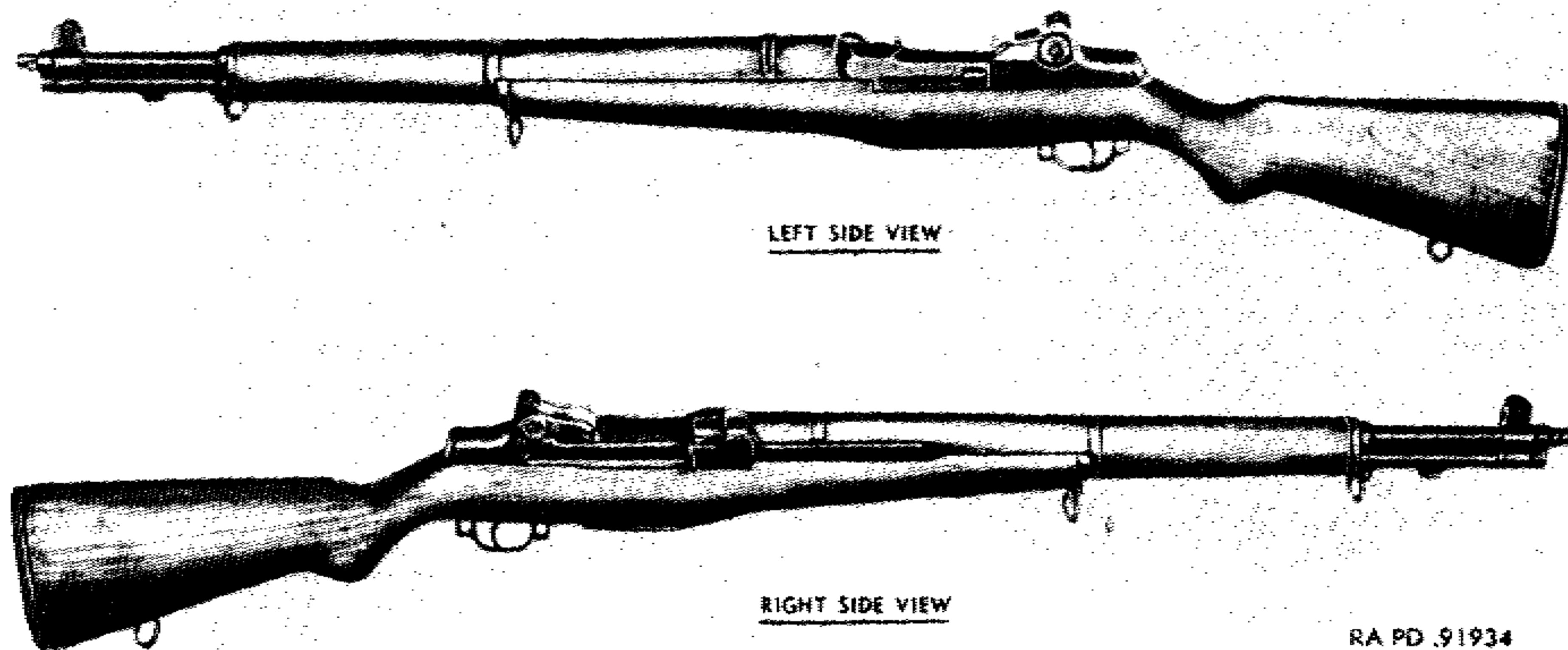

Fig. 1. U.S. rifle cal. .30, M1.

RA PD 91934



Fig. 2. U.S. rifle cal. .30, M1C (Sniper's).

stock. Flash hiders M2 or T-37 are furnished as an accessory. If the rifle is fitted with a T-37 flash hider, its removal and replacement with a conventional gas cylinder lock may cause a change in the zero. The newer T-37 flash hider has not seen as extensive issue as the older M2.

(d) The U.S. Rifle M1D (Fig. 3) differs from the M1C only in the design of the telescope mount and bracket. On the M1C, the telescope is held in a removeable mount having a dovetail slide mating with that of a bracket permanently attached to the receiver and locked in place by means of two locking screws. On the M1D, the telescope is held in a removeable mount which in turn is attached to a fixed base on the barrel of the rifle by means of one screw and dowel pin. The M1D, although of later design, had been shelved in favor of the M1C at the time the M1 rifles were superceded in the service by the M14, and therefore did not receive as extensive issue as the M1C.

3. Data: (a) U.S. Rifle, cal. .30, M1: see opposite page.

Section 2, Operation

4. Loading the rifle:

(a) Single round: to load a single round, pull the operating rod all the way to the rear. While holding the muzzle below horizontal, place a round in the chamber and seat it with the thumb. With the knife edge of the right hand against the operating rod handle, force the operating rod slightly to the rear. Push down on the follower assembly

with the thumb of the right hand and allow the bolt to ride forward. (Caution! Restrain the forward movement of the bolt with the knife edge of the right hand against the operating rod handle.) Remove the thumb from the follower assembly and release the operating rod handle, allowing the operating rod to go all the way forward.

(b) Full clip: hold the rifle at the balance with the left hand and pull the operating rod handle all the way to the rear. Place the butt of the rifle on the ground or against the thigh. With the right hand, place a full clip on the top of the follower assembly. Place the thumb on the center of the top round in the clip and press straight down into the receiver until it catches (Fig. 6). Swing the right hand up and to the right to clear the bolt in its forward movement. Note that the operating rod is not held to the rear during loading since there is no danger of it going forward as long as pressure is maintained on the top round in the clip. If the bolt does not fully close and lock, tap soundly with the heel of the right hand against the operating rod handle.

(c) Partly filled clip: hold the rifle in the same manner prescribed for a full clip. With the operating rod all the way to the rear, place an empty clip into the receiver. Place the first round into the clip and on the follower, to the left of the follower slide. Press the second round into the clip, exerting a downward, turning motion until the round snaps into place. Load the remaining rounds in the same manner (Fig. 7). With the knife edge of the right hand against the operating rod handle, force the operating rod handle slightly to the



Fig. 3. U.S. rifle cal. .30, M1D (Sniper's).

SPECIFICATIONS, U.S. RIFLE M1, .30 CAL.

Weight	9.5 pounds
Weight with bayonet M1 and sling M1907	11.2 pounds
Length (over-all) rifle only	43.6 inches
Length (over-all) with bayonet M1	53.4 inches
Length of barrel	24 inches
Length of rifling	70.8 calibers (21.30 inches)
Rifling, old barrels	Four grooves
Rifling, new barrels	Two grooves
Rifling twist	Right hand, one turn in 33.3 calibers (10 inches)
Depth of grooves, rifling	0.0040 inches
Cross-sectional area of bore	0.0740 sq. inches
Type of mechanism	Gas-operated, semi-automatic
Loading device	En-bloc clip
Rate of fire	25-30 aimed shots per minute
Cooling	Air
Sight radius	27.9 inches at 100 yd range
Trigger pull	7.5 max, 5.5 min
Normal pressure	50,000 lbs per sq in (copper)
Ammunition types	Ball, AP, tracer, grenade
Velocity (M-2 ammunition)	853 (2,800 f.p.s.) meters/sec
Maximum range (M-2 ammunition)	3,200 meters (3,450 yards)
Maximum effective range	460 meters
Front sight	Fixed blade
Rear sight	
(b) U.S. Rifles M1C and M1D (sniper's):	Adjustable peep
Length of rifle with flash hider (M2)	46.13 inches
Weight of rifle with scope, flash hider (M2), web sling and cheek pad	11.81 pounds
Weight of telescope M81, M82 or M84 with removable mount assembly	1.24 pounds
Weight of flash hider (M2)	0.44 pounds
Weight of web sling	0.26 pounds
Weight of cheek pad	0.34 pounds
Weight of rifle M1C or M1D without accessories but including permanently mounted bracket	9.75 pounds
Weight of leather sling M1907	0.50 pounds
Weight of telescope M81 or M82 only, without removeable mount	0.84 pounds
Weight of web carrying case M65	0.28 pounds
Trigger pull	6.5 pounds max, 4.5 min
Focus for distance	Universal
Maximum useful range	800 to 1,000 yards
Zero setting range (telescope)	300 yards
Field of vision at 100 yards	35 feet (M84 scope 27 feet)
Magnification	2.2 X
Eye relief (approximately)	5 inches

THE FIGHTING GARAND

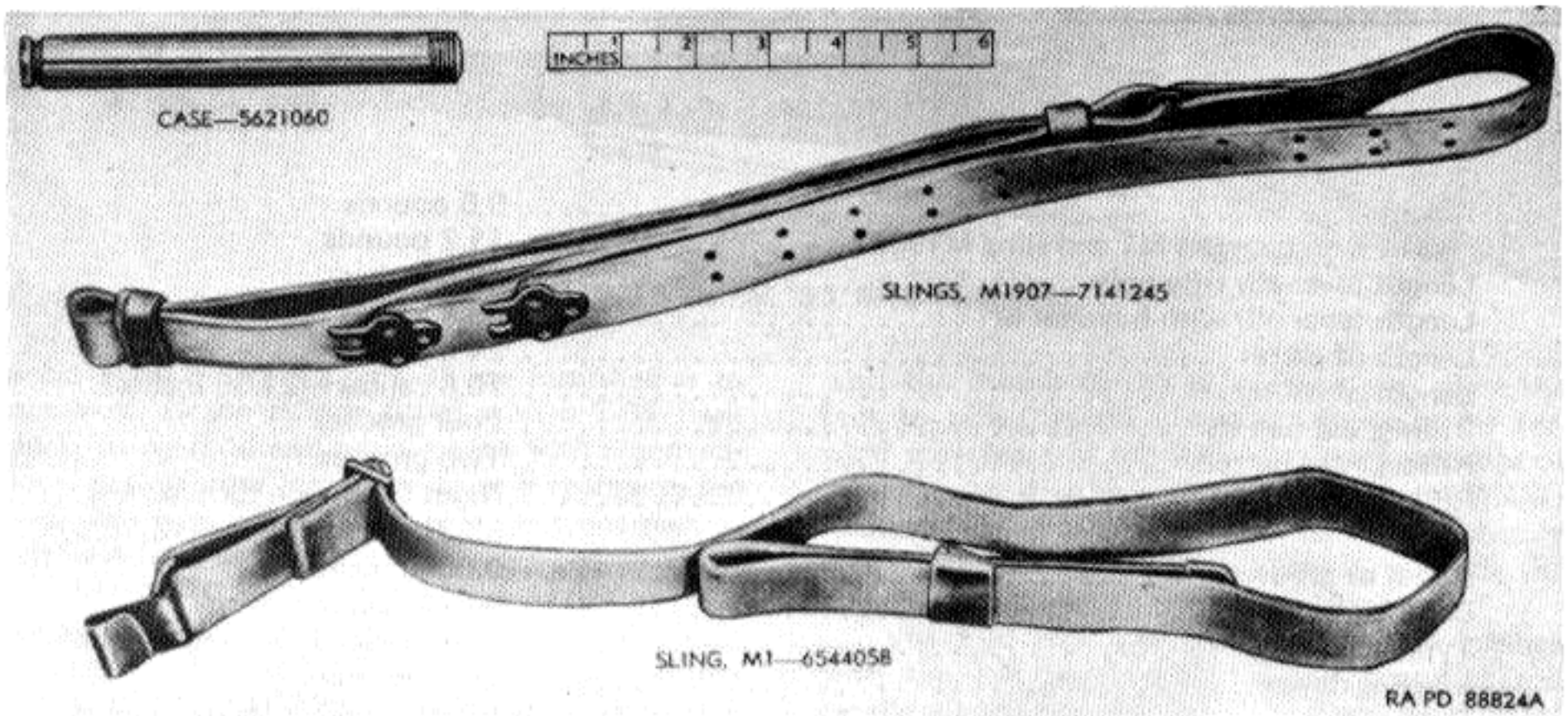

Fig. 4. Gun slings M1907 (leather) and M1 (web).

rear. Push down on the top round with the right thumb, allowing the bolt to start the top round forward. Remove the right hand and allow the operating rod to go forward.

5. Unloading the rifle:

(a) To unload a round from the chamber,

support the butt of the rifle on the thigh or on the ground; with the right hand grasp the operating rod handle and pull the operating rod slowly to the rear. At the same time, place the left hand, palm down, over the receiver to catch the round as it is ejected. This keeps the round from falling into the dirt or away from your position.

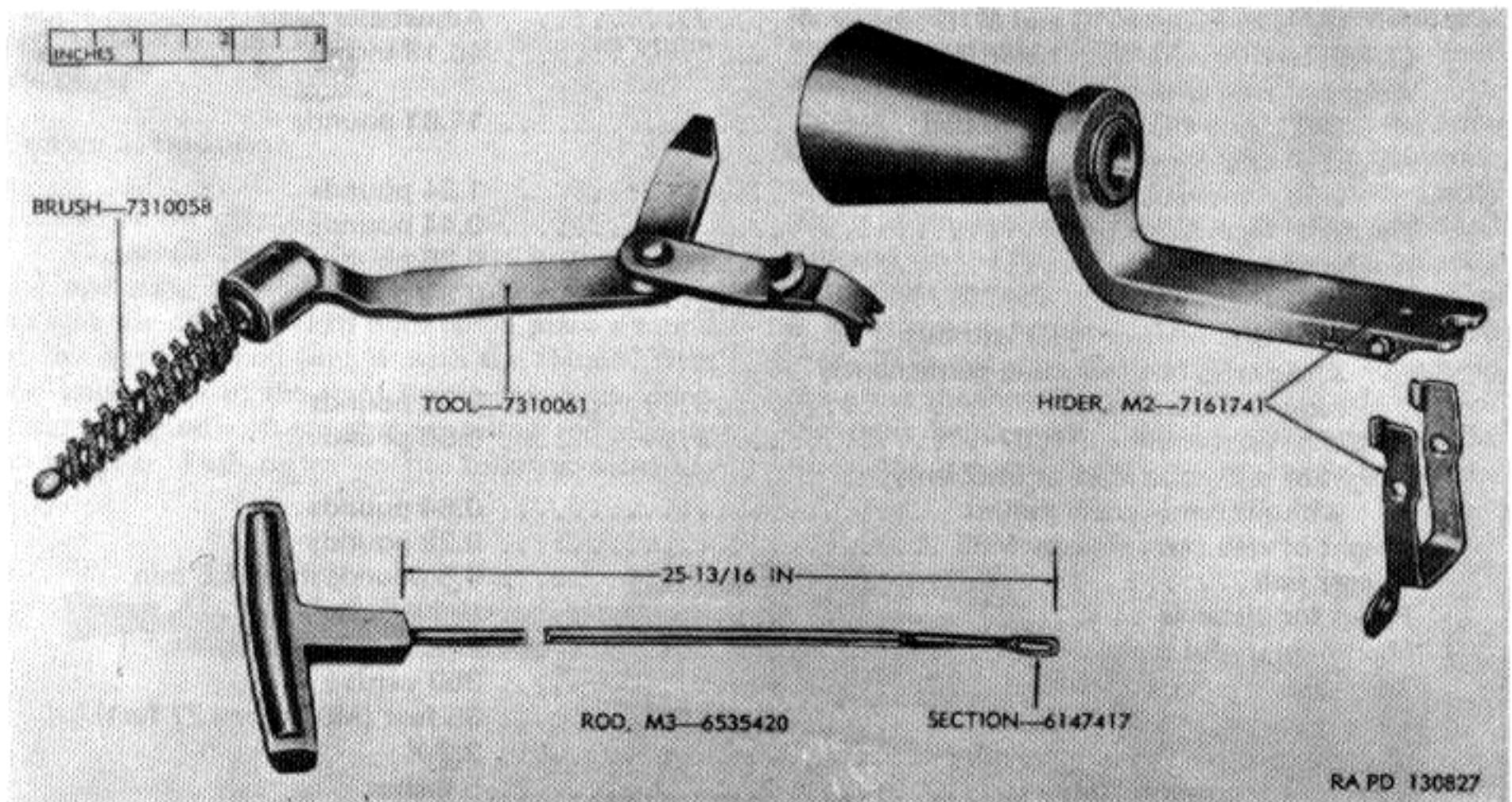

Fig. 5. Flash hider M2, cleaning rod, and tool.

THE FIGHTING GARAND

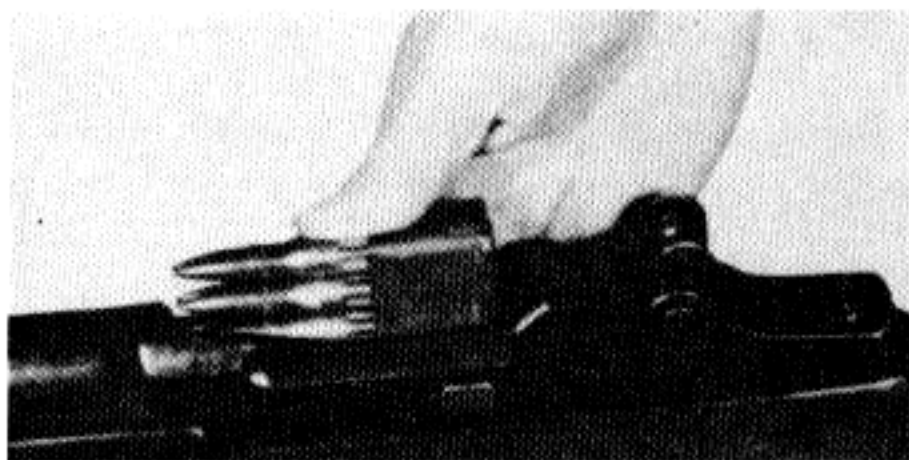

Fig. 6. Loading full clip.

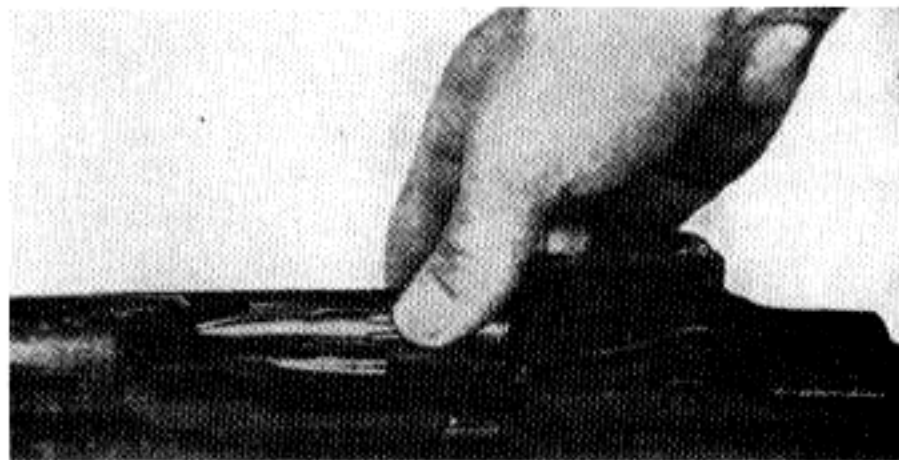

Fig. 7. Loading partly filled clip.

(b) To unload a filled or partly filled clip, unload the round that is in the chamber as described above in (a). When the operating rod reaches its rearmost position, hold it there. Place the palm of the left hand over the receiver and depress the clip latch with the left thumb, allowing the clip to be ejected up into your hand. Do not relax the rearward pressure on the operating rod handle until after the clip has been removed.

(c) The empty clip is automatically ejected from the receiver when the last round it contains is fired.

6. Loading rounds into a clip.

(a) Insert eight rounds into the clip, holding the clip and rounds in the manner shown in Fig. 8. Start placing rounds in from the lower left of the clip and make sure that each round is against the rear wall so that the inner rib of the clip engages

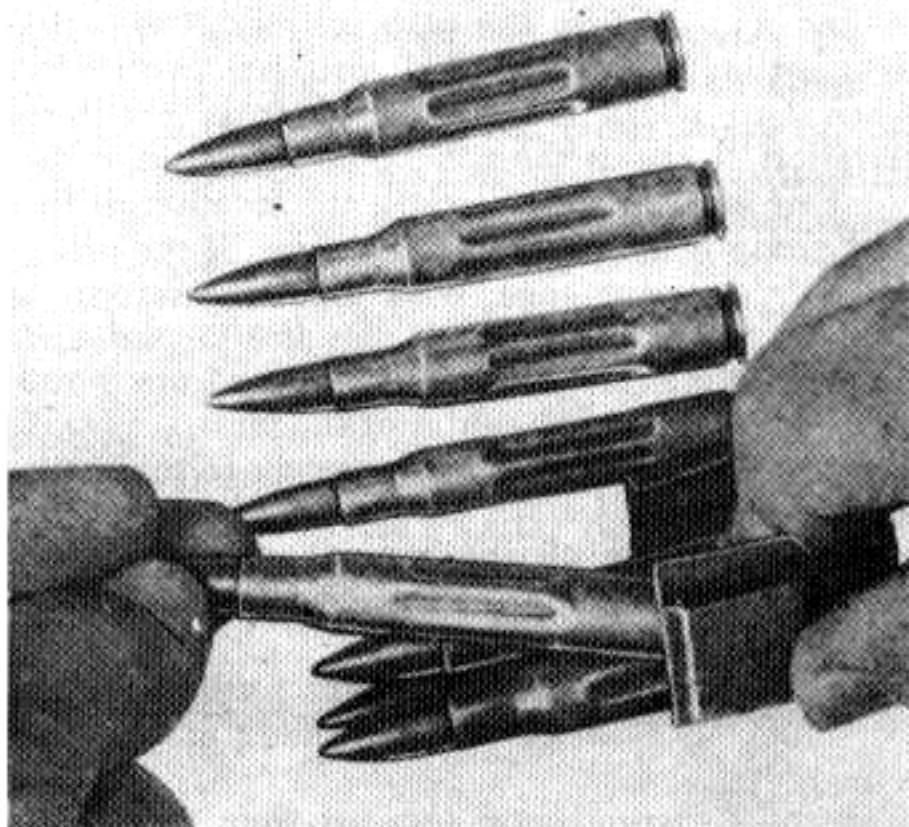

Fig. 8. Loading rounds into a clip.

the extracting groove of each round. The top round will then be on the right, making the clip easier for a right handed firer to load. For the same reason, clips are usually loaded in this manner at arsenals.

(b) Each time rounds are loaded into a clip, the clip should be checked for long rounds. If one round extends beyond others in the clip, it will make the clip difficult to load into the rifle. The long round should be seated by removing the top round, pushing the long round into place, and replacing the top round. Do not tap the bullet against a solid surface to seat the long round, as this may push the bullet back into the cartridge case, breaking the bullet seal or damaging the bullet itself. This can result in changes in the ballistic performance of the round.

7. Sight adjustment:

(a) Iron sights (M1 rifle): The rear sight (Fig. 9) can be adjusted to correct for a wind that is strong enough to blow a bullet off its course, or simply to change the strike of the

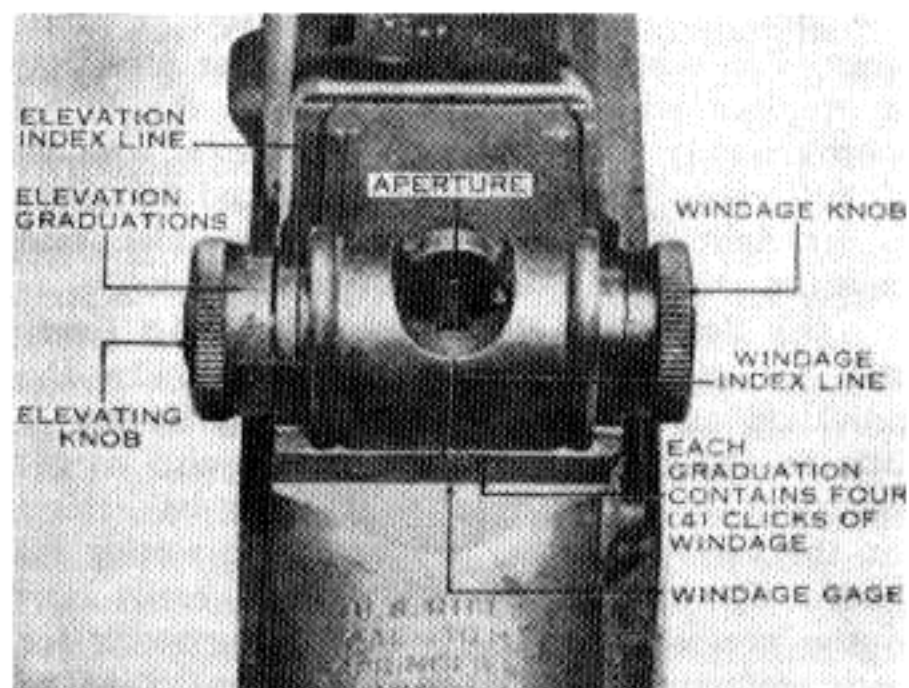

Fig. 9. Iron peep sights, M1 rifle.

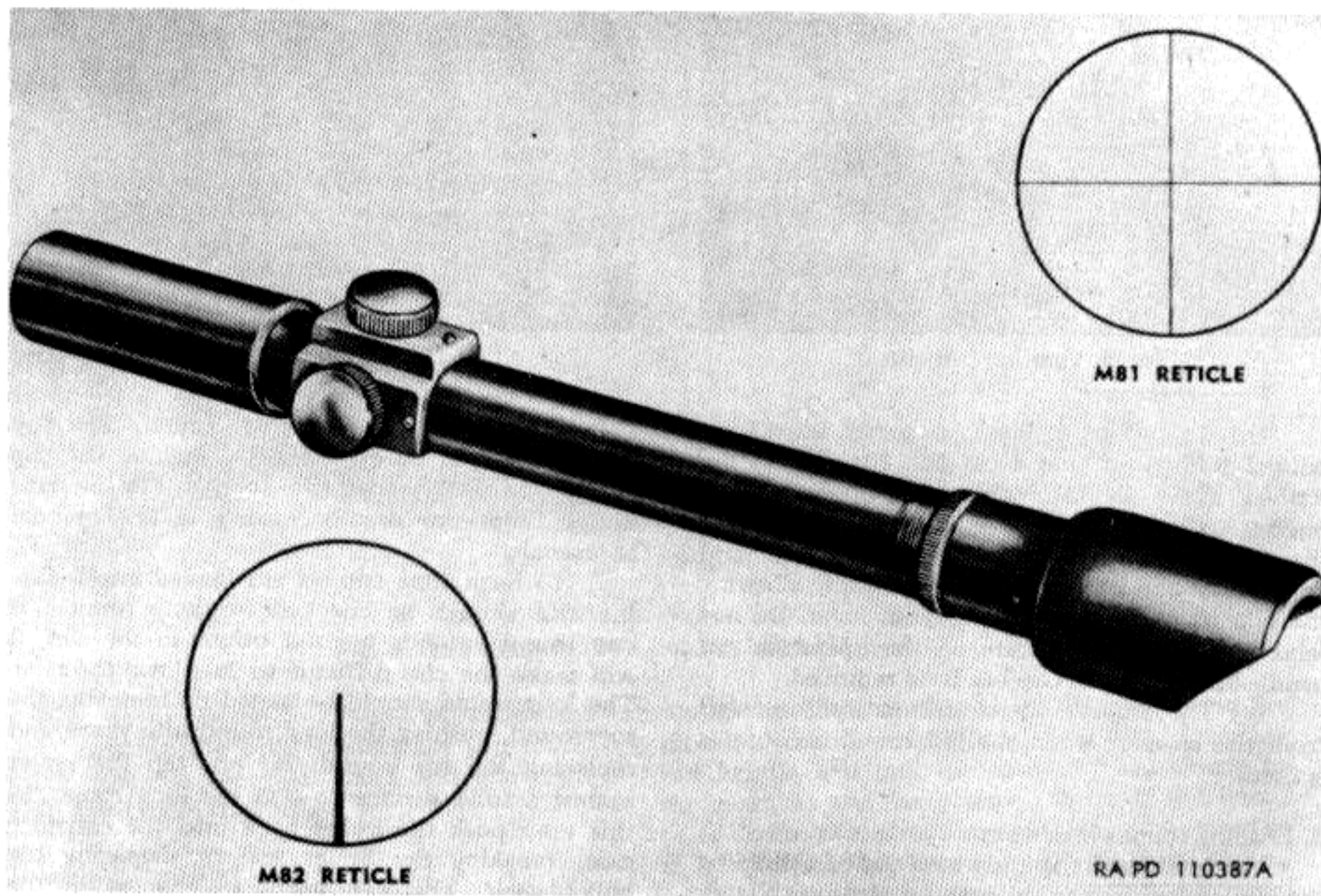

Fig. 10. Rifle scopes M81 and M82.

bullet to another spot on the target. The strike of the bullet can be made higher or lower (elevation) or can be moved to the right or to the left (windage). The elevation and windage knobs make audible clicks when they are turned, and each click changes the strike of the bullet approximately one inch on the target for every 100 yards of range. For example, 2 clicks of either elevation or windage will move the strike of the bullet approximately four inches on a target at a range of 200 yards. Windage can be adjusted 16 clicks to the right or to the left of center index, and elevation can be adjusted from 0 to 72 clicks.

(b) Zero and Battle-Sight for M1: Every rifle has certain characteristics that make the individual piece fire a little high, a little low, a little to the right or the left. To be able to get consistent hits, the rear sight must be zeroed for the various ranges, and the sight setting recorded. The data for the rifle's zero is easily kept in the accessory compartment of the stock for ready reference. To move the mean point of impact up, raise the rear sight. To move the mean

point of impact to the right, move the sight to the right, and so on. Several rounds should be fired from a bench or sandbag rest from various ranges to find and confirm the zero settings. The battle sight setting is the 300-yard zero, less two clicks. When two clicks are subtracted from the zero elevation, it causes the rifle to be zeroed in at the point of aim. In other words, the location of the shot group is moved from the center of the bull's-eye to the lower edge. With this sight setting, a rifleman can hit his point of aim at 300 yards and can engage man-sized targets at ranges from 0-400 yards by aiming at the center of the mass.

(i) To calibrate the rear sight to the battle sight setting you:

-run the aperture all the way down and loosen the screw in the center of the elevating knob until you can turn the knob forward.

-turn the elevating knob forward until the 300-yard index line is opposite the index line on the receiver.

-turn the elevating knob forward from this point the number of clicks equal to the 300-yard zero

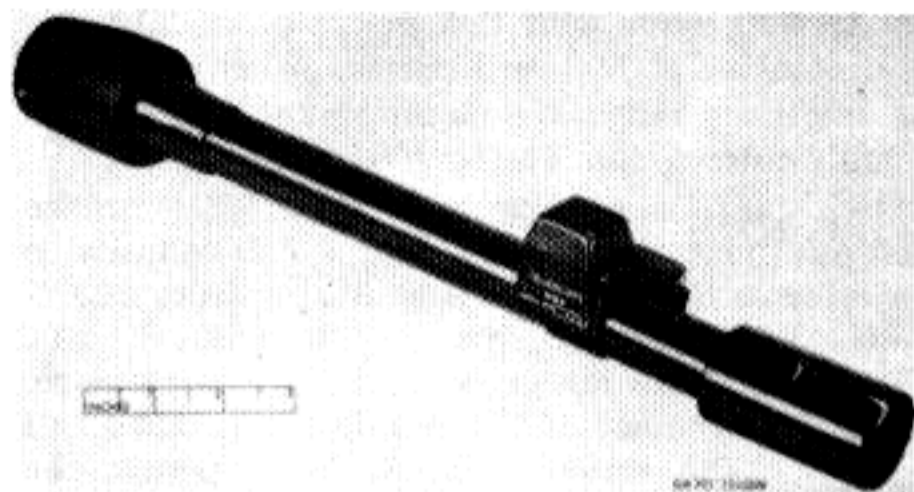

Fig. 11. Rifle scope M84.

in elevation, less two clicks.

-hold the elevating knob in position with your left hand and tighten the center screw, then run the aperture all the way up and tighten the screw.
-check your setting by turning the elevating knob back until the 300-yard index line is opposite the index line on the receiver, then turn it as far forward as you can, counting the clicks. The number of clicks you can turn the elevating knob forward should be equal to your battle sight setting.

(ii) To set the battle sight on the older type sight (with locking nut) you:

-set the 300-yard zero in elevation less two clicks. Lock the rear sight at this point by tightening the locking nut.

-loosen the screw in the center of the elevating knob and turn the knob until the battle sight index line is opposite the index line on the receiver.

-tighten the screw in the center of the elevating knob.

-check the setting as described in (i) above.

(iii) When the rear sight has been calibrated to the battle sight zero, the range indicators on the elevating knob may be used. If the rifleman has time in combat, he can set the estimated range to a target on the rear sight and deliver more accurate fire. This is particularly advantageous when engaging targets at ranges over 300 yards.

(c) Use of the Sniper Scopes: a telescope sight enables the sniper to aim with great accuracy, and has several advantages over ordinary rifle sights. Its magnification gives a better view of the target.

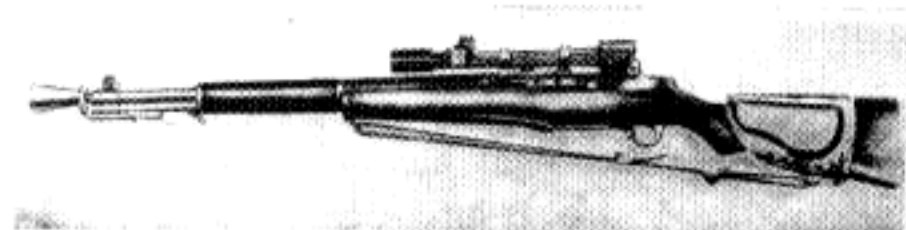

Fig. 12. Rifle scope M84 on M1C rifle.

The crosshair or sight post is more distinct than the front sight on an M1, and covers a smaller area on the target. The target and reticle both appear in focus to the firer, which eliminates the need for attempting to align a front and rear sight with the target. The telescope sight adds to the period of visibility at dawn and at dusk, and increases the probability of hits at all ranges.

(i) The rifle scopes M81 and M82 (Fig. 10) are basically the same, the difference being in the reticle. The M81 scope has a crosshair, the M82 has a simple post. The magnification and field of view are given in Para. 3.

(ii) The rifle scope M84 (Fig. 11 and 12), is somewhat different in construction than the M81 and M82, and has a combination post-crosshair reticle. The M84 scope is standard on the rifle M1C.

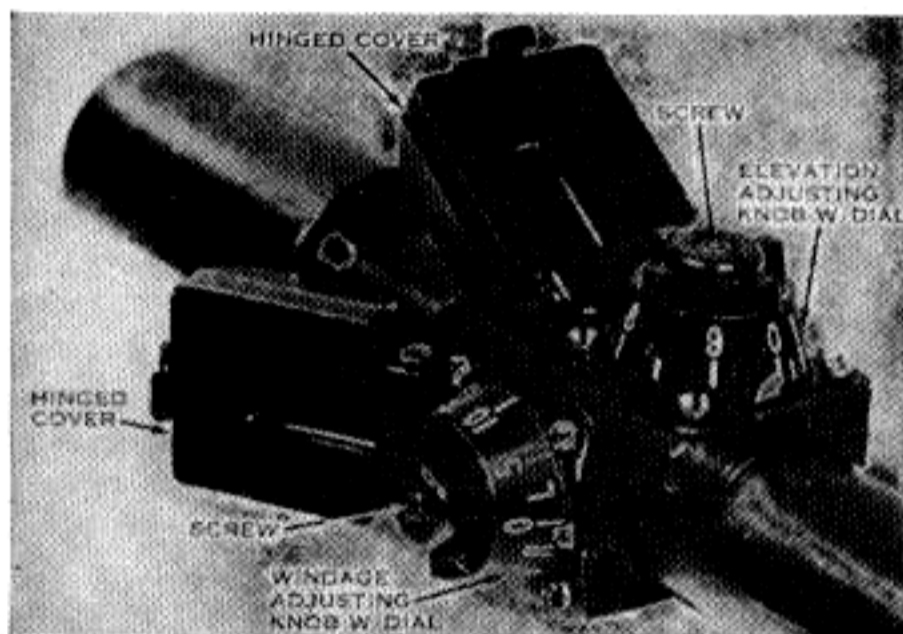

Fig. 13. Windage and elevation knobs, M84 scope.

(iii) With a telescope sight, the reticle is moved in the direction opposite to the one the firer wishes to move the strike of the bullet. This was taken into account in the design of the elevation and windage knobs. On the M84 scope, for example (Fig. 13) when the windage knob is turned away from the firer (in the direction indicated by the letter "R"), the reticle moves to the left, but the strike of the bullet is moved to the right. When the windage knob is moved in the direction indicated by the letter "L", toward the firer, the reticle moves to the right but the strike of the bullet moves to the left. To raise the strike of the bullet, the elevation knob is turned in the direction of the higher number. This moves the reticle down, but the strike of the bullet is moved up.

(iv) The elevation knob (Fig. 13) is

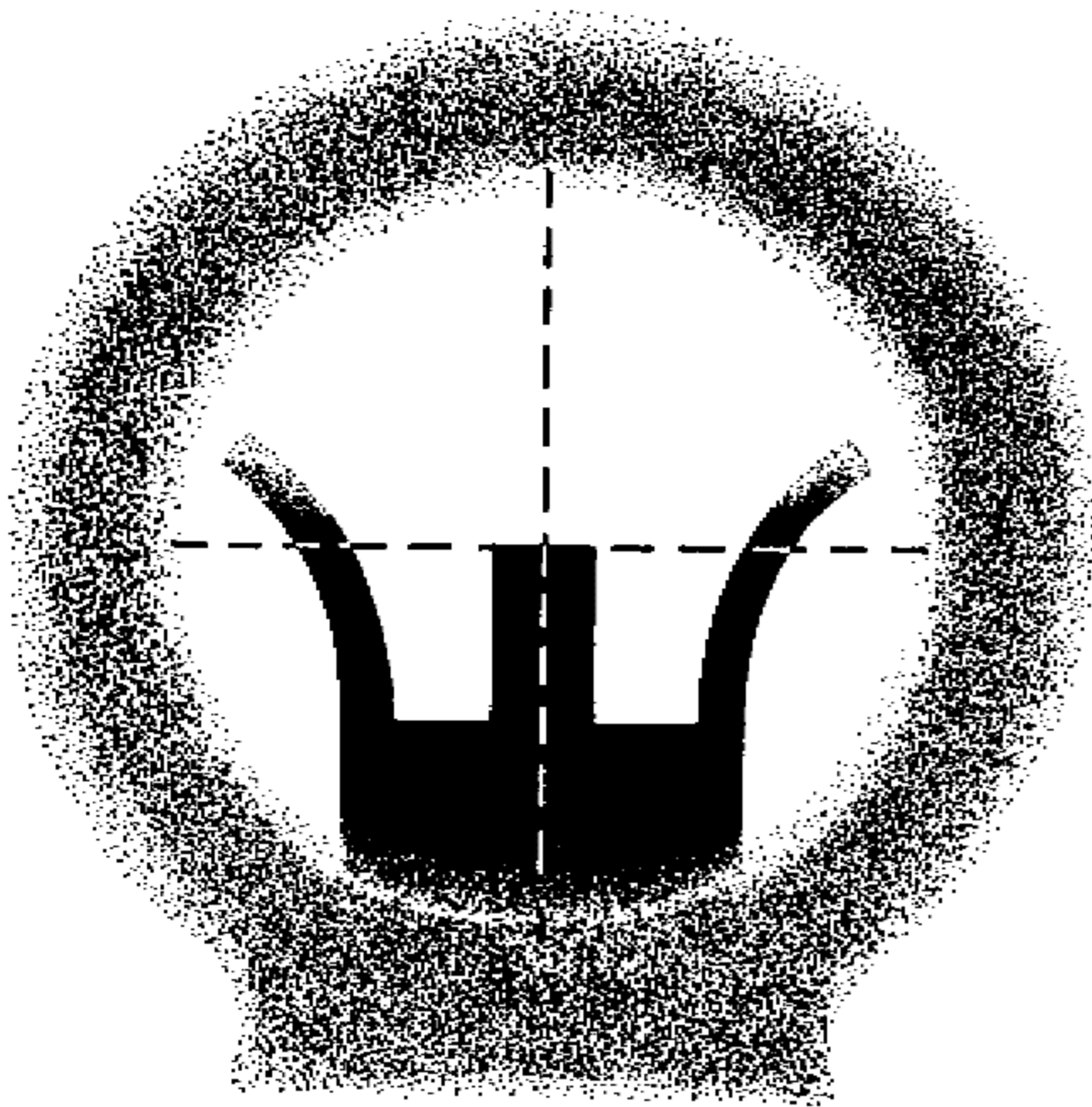

Fig. 14. Correct sight alignment, M1 rifle.

mounted on top of the tube. It has, on the M84 scope, a hinged protective cover that is held closed by a friction catch. The elevation screw has 32 threads to the inch. A complete turn gives 40 minutes of angular movement of the sight post. Each minute-of-angle change is held by a detent within the knob. While the click is not normally audible, it can be felt. One click equals one minute or one inch per 100 yards of range. The elevation scale starts at zero yards and goes

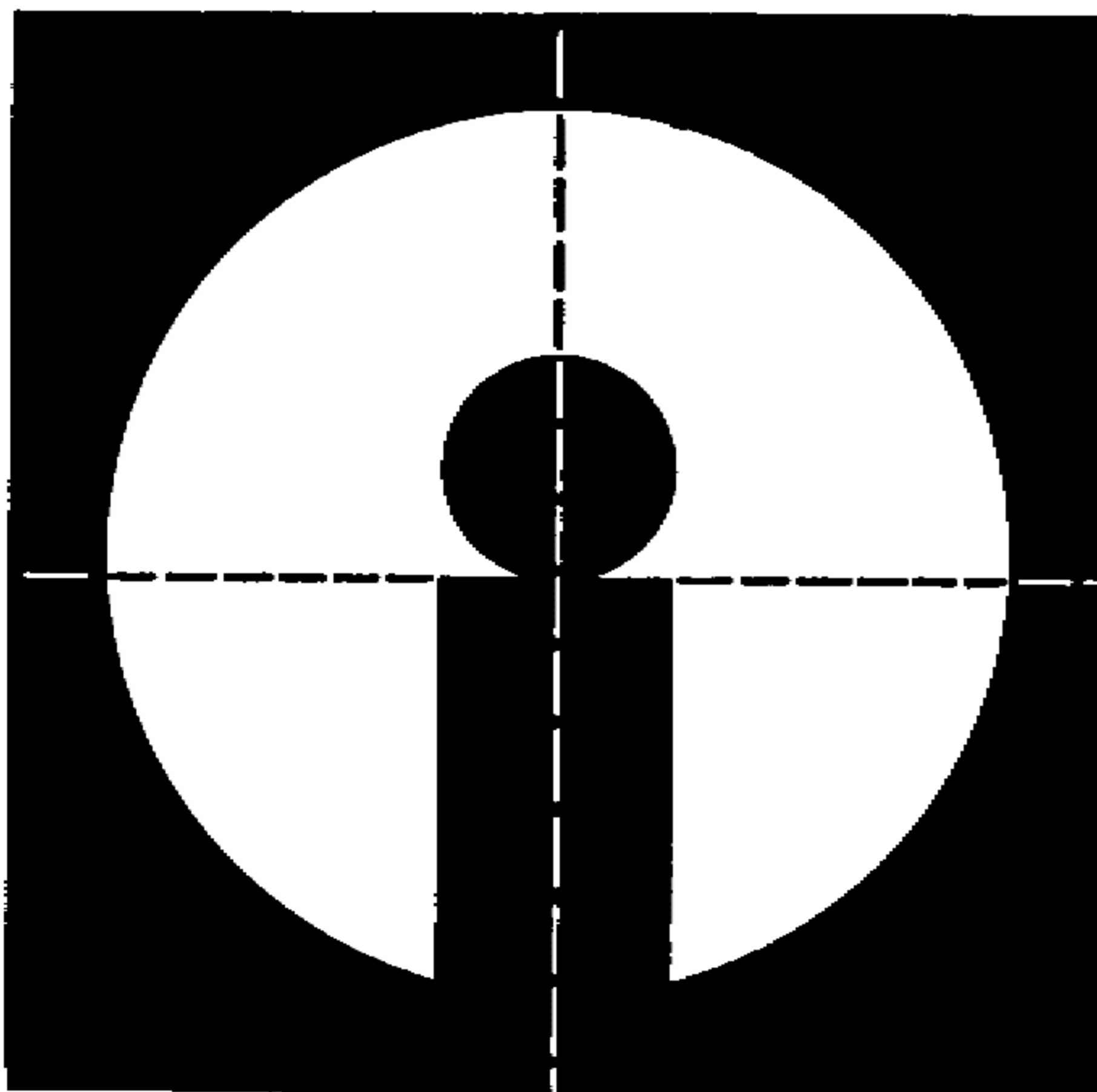

Fig. 15. Correct sight picture, M1 rifle.

up to 900 yards with tick marks every 50 yards and numbers at 100-yard indexes. When calibrated at any given range, the elevation knob is approximately correct from one to 900 yards.

(v) The windage knob (Fig. 13) is on the left of the tube. The windage scale is adjustable in minutes of angle, and is graduated from 20 minutes left, through zero, to 20 minutes right. One click equals one inch per 100 yards of range. A total movement of 100 minutes (two and a half turns of the knob) is available to permit the sight to be calibrated to correct for mount misalignment.

(vi) The eyepiece shield, a synthetic rubber cylinder with a cut-away at the bottom, fits on the eyepiece of the tube. It cuts down light reflection, gives protection from rain, and provides a non-metallic surface for possible helmet contact. The shield should extend approximately one inch beyond the tube. On the M84 scope, the objective lens is shielded by a lens shade, which is a metal retractable tube that can be extended one inch beyond the cover glass. It prevents light reflection that might give away the sniper's position.

(d) Zeroing the M1C and M1D: The Rifles M1C and M1D are zeroed in the same manner as the M1. The only difference is that the sniper zeroes so that the point of aim and point of impact are the same. The M1C and M1D are ordinarily zeroed at 400 yards. After the M1C or M1D has been zeroed at 400 yards, the elevating knob should be calibrated at that range. On the M84 scope, for example, this is done by holding the elevating knob tightly after it is set at the correct elevation, and loosening the locking nut on top. Then one can lift the elevating knob, align the Fig. 4 with the index pointer, and tighten the locking nut. After the elevating knob has been calibrated in this way, it can be turned to any setting from 100 to 900 yards and be correct within one minute of angle.

8. Firing the M1, M1C and M1D. To fire the Garand rifles, first load, as shown in Para. 4. Engage the safety (located directly in front of the trigger guard) by pushing it back into the trigger guard until it clicks. It may be removed from safe with the trigger finger when you are ready to fire. It may also be engaged before loading if desired.

(a) Assume the position you desire (Fig. 16 thru 24), align the sights as shown in Fig. 14, obtain the correct sight picture on the target as shown in Fig. 15, remove the safety, squeeze and fire. When using the sniper scopes, align the

THE FIGHTING GARAND

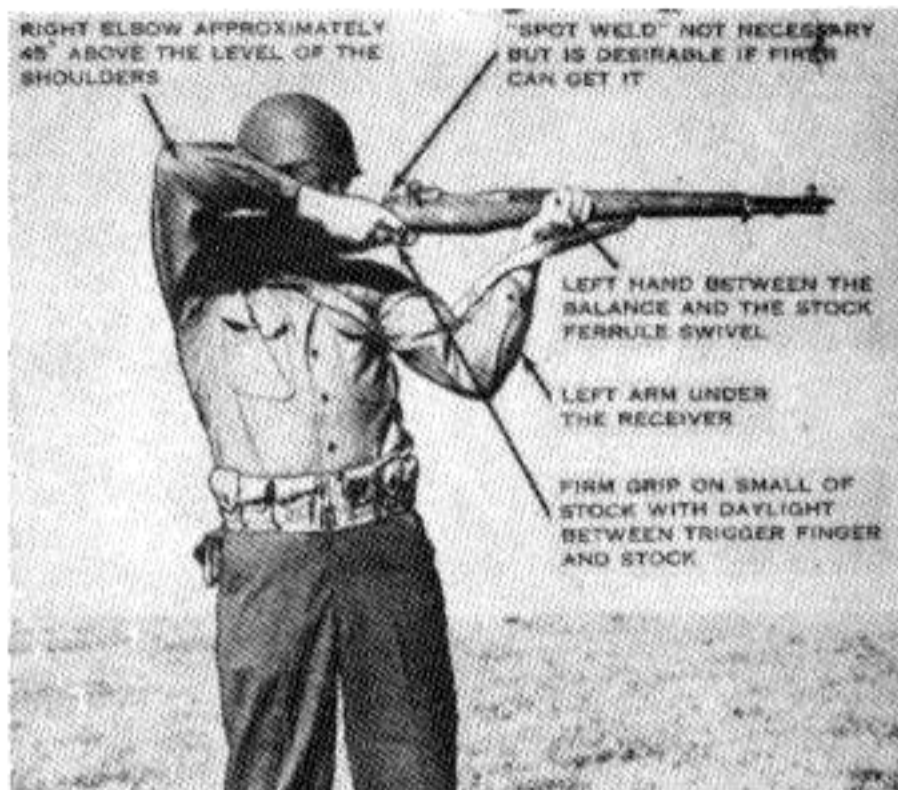

Fig. 16. Standing position.

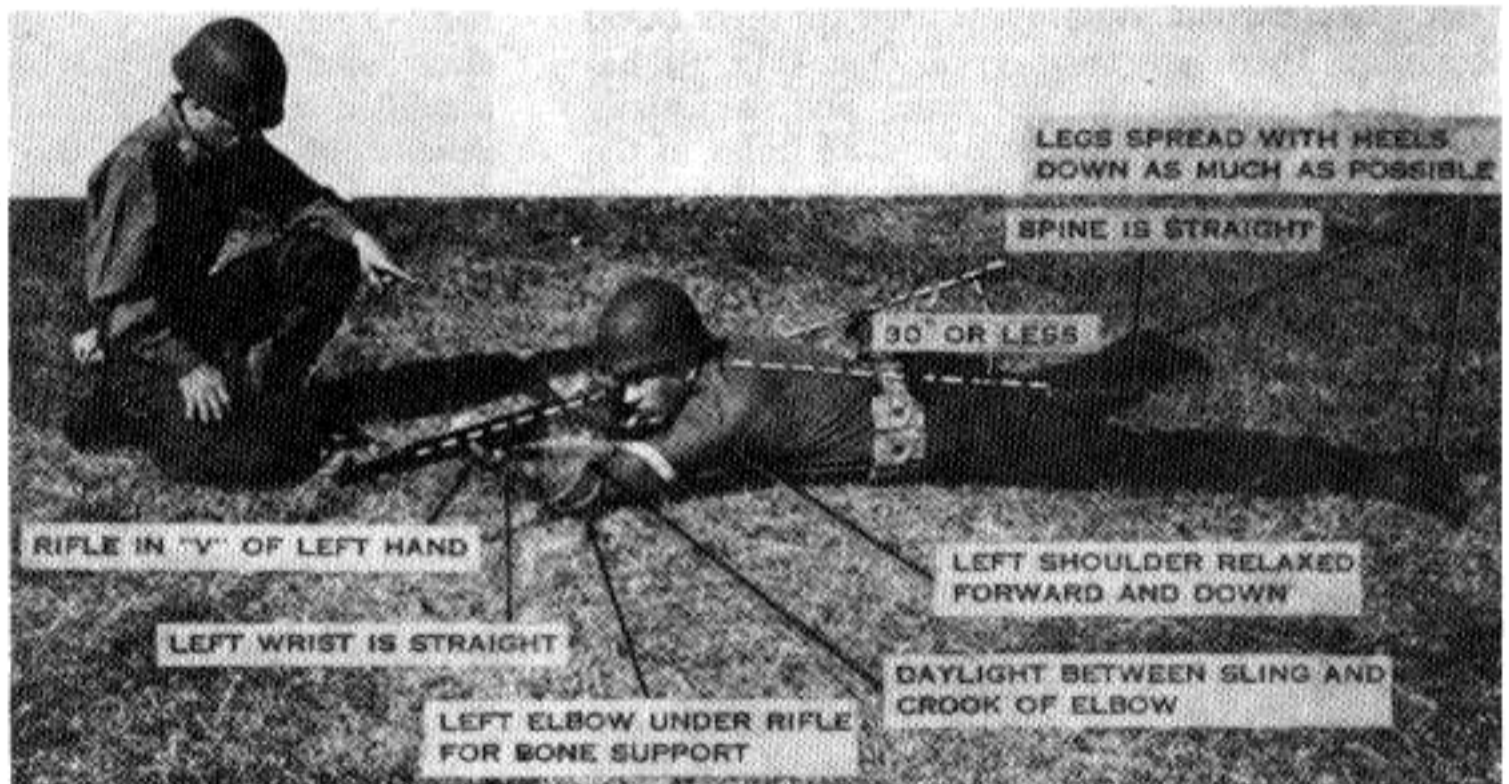

Fig. 17. Prone position.

Fig. 18. Reloading from prone position.



crosshairs or top of the post on the center of the target.

Section 3, Ammunition

9. The M1, M1C and M1D Garand rifles fire .30 U.S. (.30-06) ammunition. Commercial sporting type ammunition will usually function if the bullets are of the right length, and they are loaded

to pressures approximating those of military loads. When using other than military issue ammunition, the sights (peep or scope) must be zeroed in for various ranges with the particular type of ammunition, due to differences in velocities and wind-bucking characteristics of the particular round. Military ammunition is marked on the tip of the bullet in color, indicating the type of bullet.

(a) M-2 ball, the most common of the military loads, is not marked in color, as it is the only one left plain (aside from the frangible ball, below). It has a gilding-metal jacket. The length of the bullet is 1.123 inches. (Fig. 25 and 26)

(b) M-2 armor-piercing, is marked with a black tip. (Fig. 25 and 26)

(c) M-1 incendiary, is marked with a blue tip. (Fig. 25 and 26)

(d) M-1 tracer, is marked with a red tip (Fig. 25 and 26)

(e) M-25 tracer, is marked with an orange tip. (Fig. 25 and 26)

(f) M-25 tracer, (T72E1, opposed to T10, above), is marked with an orange tip. (Fig. 25 and 26)

(g) M-14 armor-piercing, is marked with a white tip. (Fig. 25 and 26)

(h) M-22 frangible ball, is unmarked, but is identifiable by its bullet length, which is 1.185 inches (as opposed to 1.123 for M2 ball). (Fig. 25 and 26)

(i) M-3 rifle grenade cartridge is used for launching rifle grenades and pyrotechnic signals in conjunction with the grenade launcher. (Fig. 27)

(j) M-1909 blank, is used for firing salutes and training, and signaling.

THE FIGHTING GARAND



Fig. 19. Kneeling position.

(k) Cartridge, dummy, is used for mechanical training. There are two types. One (Fig. 8) has longitudinal grooves in the case, and is usually tin-plated. Another merely has small holes in the case, and no primer. These are also of use on the range when mixed in with a clip of ammo, to detect flinching on the part of the firer.

(l) The approximate maximum range and average muzzle velocity of the .30 ammunition issued for the M1, M1C and M1D rifles is:

Cartridge:	Max. range (yds)	Feet/second
Ball, M2	3,500	2,800
Tracer, M1	3,350	2,750
Incendiary, M1	2,875	3,020
Armor-piercing, M2	3,160	2,770
Armor piercing, incendiary M14	3,300	2,830

(m) Ammunition for the .30 M1 series of rifles usually comes packed in eight-round clips (Fig. 28 and 29), which in turn are packed in



Fig. 21. Sitting position.



Fig. 20. Squatting position.

bandoleers, and in metal cans. Ammunition may also come packed in 20-round boxes, and clips are filled as shown in Para. 6. Grenade cartridges usually come in packages of ten.

Section 4, Use of the M1, M1C, M1D with Grenade Launchers

10. All three models of the Garand rifle may be used with the various grenade launchers, with the exception of an M1C or M1D which has been fitted with the T-37 flash hider. Older type gas cylinder lock screws will not accept other than the M-7 grenade launcher. When using the M-7A1, M-7A2, or M-7A3 grenade launchers, be sure the gas cylinder lock is one with a built-up portion on the top front of the lock, as this is designed to prevent breakage when the launcher moves to the rear in recoil.

(a) The Grenade Launcher M7 (Fig. 30)



Fig. 22. Alternate (cross-legged) sitting position.

THE FIGHTING GARAND



Fig. 23. Aerial target position.

is the earliest type of launcher used with the Garand. Unlike the later models, it does not have a spring and slide assembly in the frame which allows the valve in the gas cylinder lock screw to remain closed except when opened by the recoil of a grenade being launched. It has a long stud which fits in the gas cylinder lock screw and holds the valve open all the time the launcher is attached. Thus, due to the escaping gas, the rifle will not

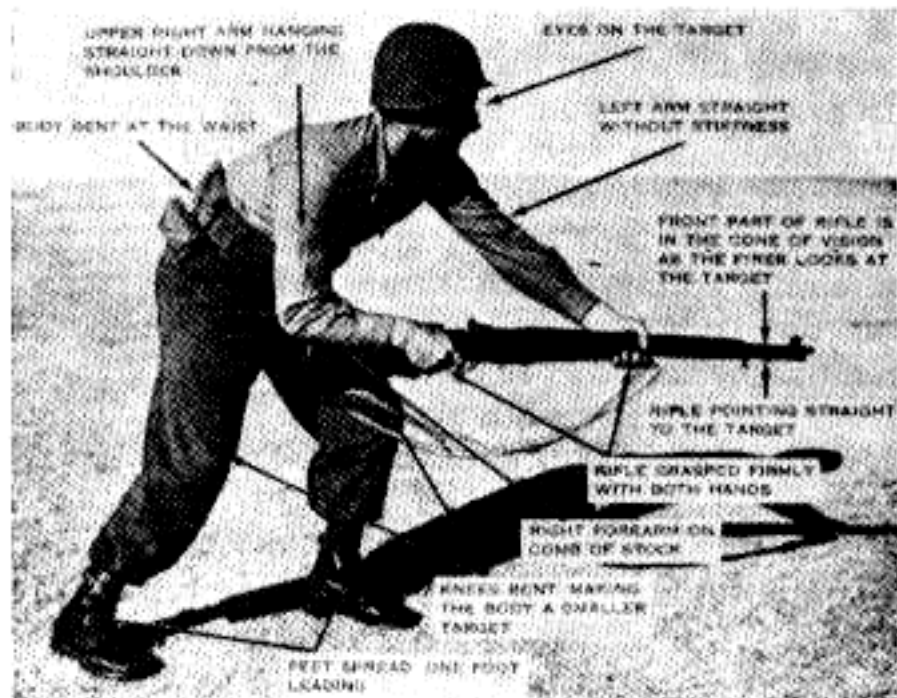
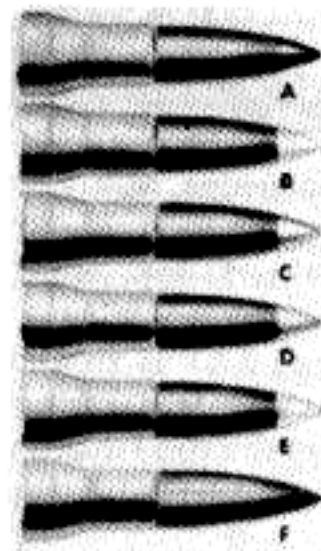

Fig. 24. Crouch position.



- A. CARTRIDGE, ARMOR PIERCING, CAL. .30 M2
- B. CARTRIDGE, ARMOR PIERCING, INCENDIARY, CAL. .30 M14 (T15)
- C. CARTRIDGE, INCENDIARY, CAL. .30, M1
- D. CARTRIDGE, TRACER, CAL. .30, M1
- E. CARTRIDGE, TRACER, CAL. .30, M25 (T10), OR M25 (T72E1)
- F. CARTRIDGE, TEST, HIGH PRESSURE.

Fig. 25. Tip markings, .30 ammunition.

fire regular ball ammunition semi-automatically when the launcher is attached. The valve must be open when firing a grenade to allow the excess gas to escape without harm to the mechanism. As the M-7 grenade launcher has a rather weak circular type grenade retaining spring, it is not recommended for use with casualty producing grenades, due to the danger of the grenade sliding

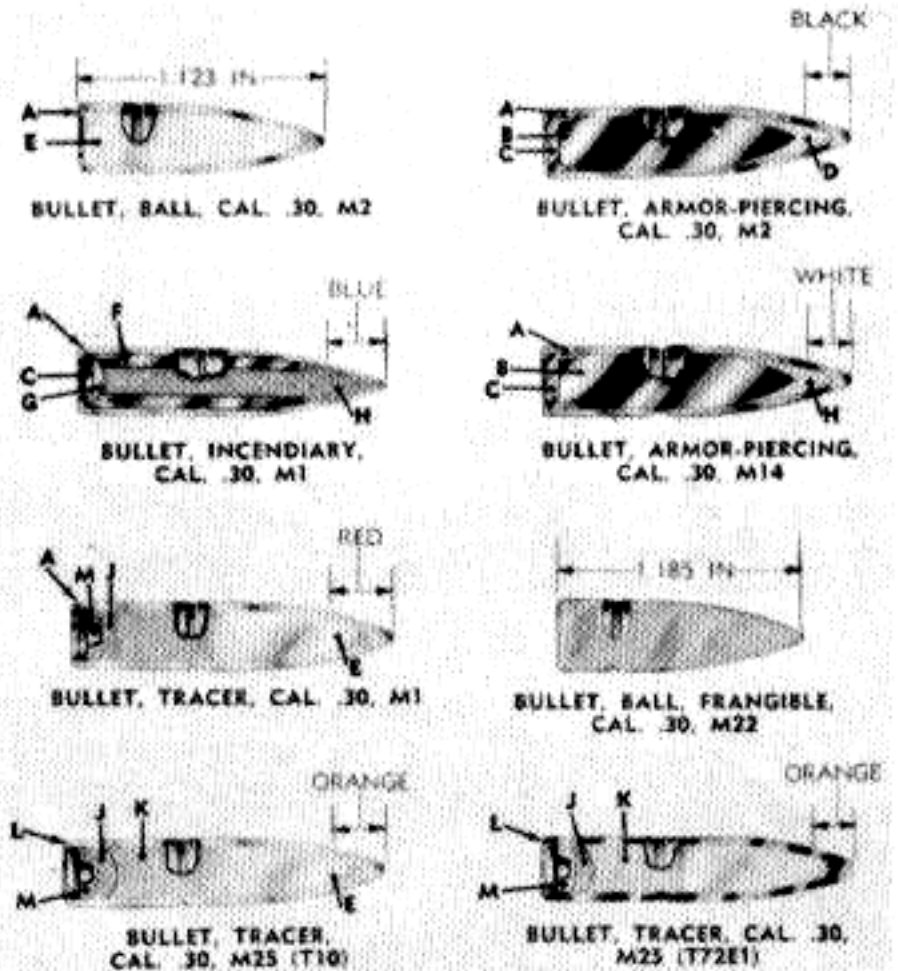

- A. GILDING METAL JACKET
- B. HARDENED ALLOY STEEL CORE
- C. GILDING METAL BASE FILLER
- D. LEAD "T" SHOT POINT FILLER
- E. LEAD-ANTIMONY SLUG
- F. STEEL BODY
- G. LEAD SHOT No. 4 BODY FILLER
- H. INCENDIARY COMPOSITION
- J. TRACER COMPOSITION - DIM
- K. TRACER COMPOSITION - BRIGHT
- L. GILDING METAL CLAD STEEL JACKET
- M. IGNITER COMPOSITION

Fig. 26. .30 bullets cross-sectioned.

THE FIGHTING GARAND



Fig. 27. Grenade launching cartridge, M3.

off the muzzle if the rifle is tilted downward, and exploding prematurely.

(b) The Grenade Launcher M-7A1 is similar to the earlier M-7, except that there is a spring-loaded slide assembly which allows the pin (shorter than on the M-7) to be out of contact with the

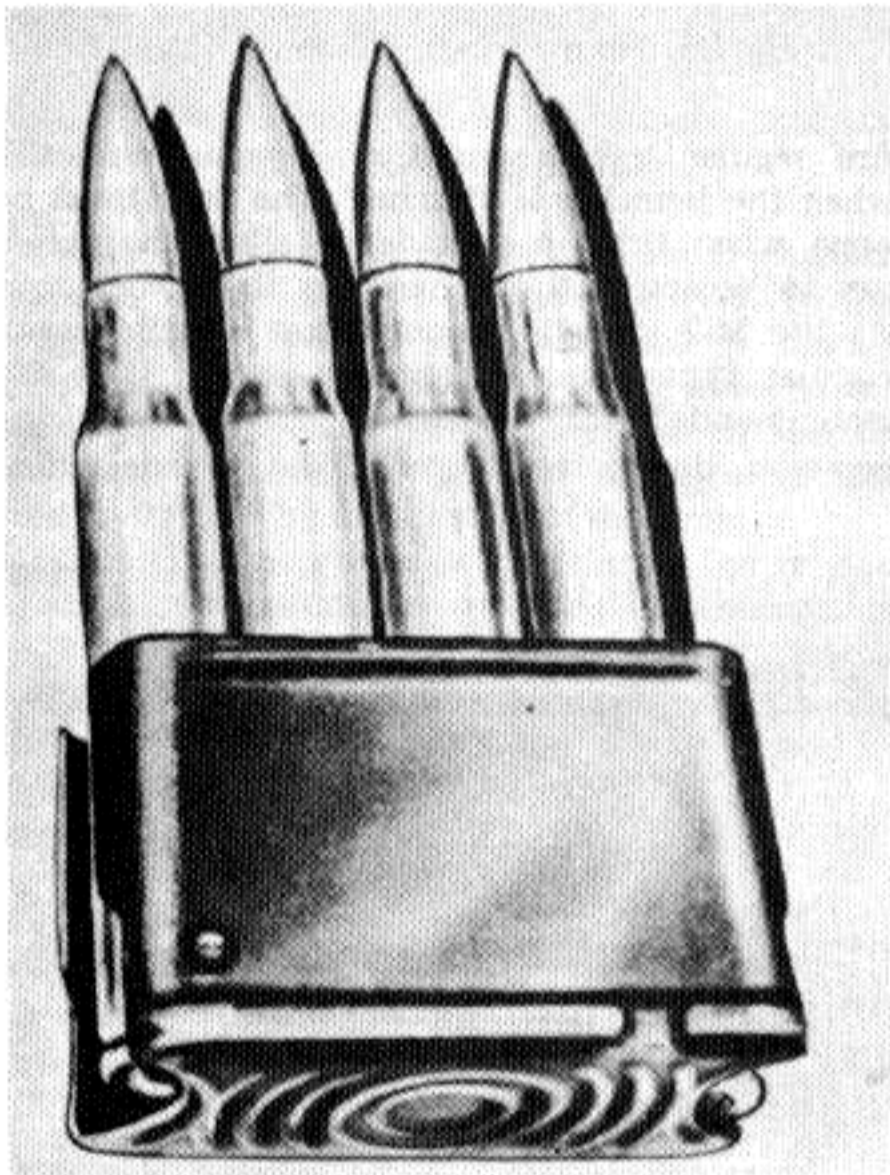

Fig. 28. Loaded clip.

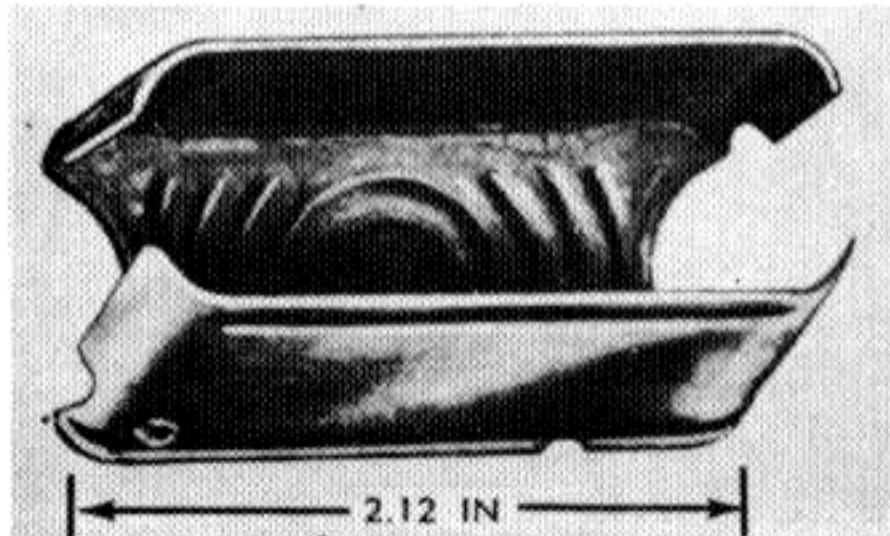

Fig. 29. Empty clip.

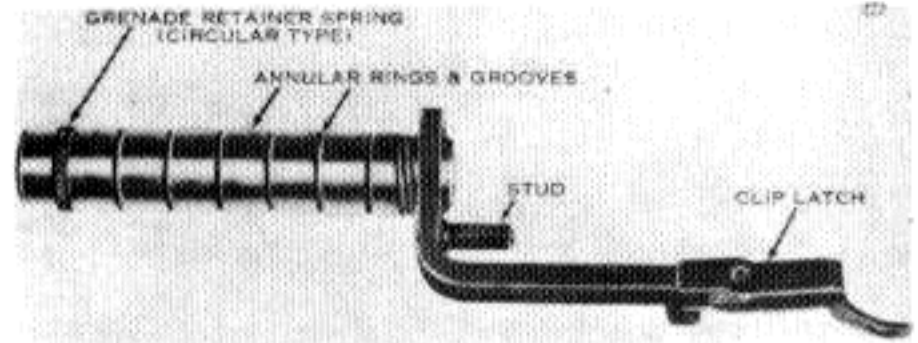

Fig. 30. Grenade launcher M-7.

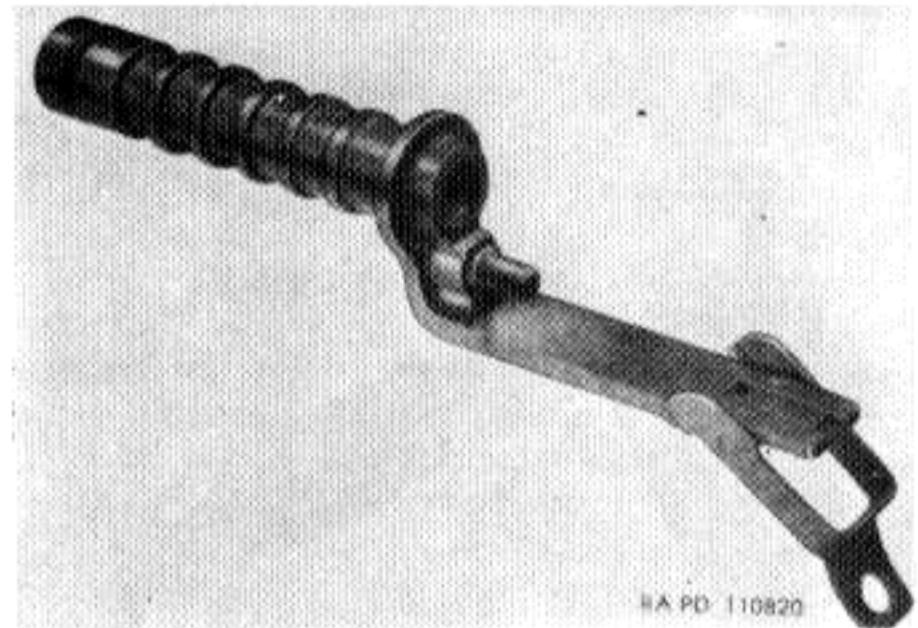

Fig. 31. Grenade launcher M-7A1.

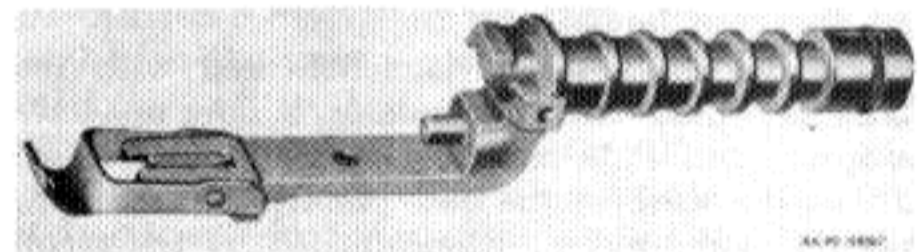

Fig. 32. Grenade launcher M-7A2.

valve in the gas cylinder lock, except when the launcher moves back under the recoil of a grenade being launched. This allows the rifle to be used as a semi-automatic with the launcher attached, and still allows the high-pressure and excessive gas from a grenade launching cartridge to escape from the mechanism when a grenade is fired. (Fig. 31)

(c) The Grenade Launcher M-7A2 differs from the M-7 and M-7A1 in that it has a clip type retaining spring, which firmly holds the grenade on the launcher until it is fired. This makes it reasonably safe to fire casualty-producing grenades from the launcher, with no fear the round will slide off the tube and explode prematurely if the muzzle is slightly depressed. (Fig. 32)

(d) The Grenade Launcher M-7A3 (Fig. 33), is quite similar to the M-7A2, except that it is about 1 1/2 inches longer, allowing it to be used to fire the heavier new types of anti-tank grenades which have longer stabilizing fins. It also has the

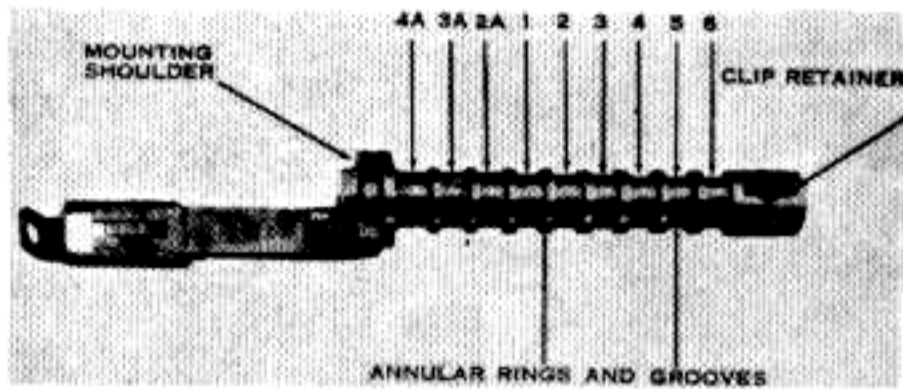

Fig. 33, Grenade launcher M-7A3.

clip-type retaining spring, and is safe to use when firing casualty-producing grenades. The M-7A3 is the standard grenade launcher used with the Garand rifles, the earlier types being limited or substitute standard.

11. Rifle Grenade Sight. The Rifle Grenade Sight M-15 (Fig. 34) provides an angular measurement of elevation for firing rifle grenades. It can be used for both low and high angle firing.

(a) The sight consists of a mounting scale plate and a sight bar assembly. The mounting scale plate is attached to the left side of the rifle stock by two wood screws. Two identical sets of calibrations are located on the lip of the mounting plate. Each set is calibrated in 5 degree intervals from 0 degree to 60 degree elevation, and each is numbered in 10 degree intervals. The under edge of the lip is serrated to engage the click spring of the sight bar assembly. Each click is a 5 degree change in elevation. The sight bar assembly consists of a 13-centimeter (5 inch) sight bar with a front sight post, a rear peep sight mounted on a sight leaf, a leveling bubble, and an elevating screw. The front sight post and the rear sight are used, by sighting through the rear peep sight over the front sight post at the target. At the rear of the peep sight are four 1 degree graduations (Fig. 35). These are used for making 1 degree to 4 degree changes in elevation for low angle fire. Five clicks of the elevating screw (12 minutes each) will make a 1 degree change on the rear peep sight. For high angle fire, the front sight post, rear peep sight and elevating screw are not used. Instead, the sight bar assembly is rotated until the index line on the sight body bracket is aligned with the appropriate degree setting on the mounting scale plate. After you assume a correct firing position, raise or lower the rifle until the leveling bubble is centered in its vial. This places the same angle on your rifle as you originally placed on the sight.

(b) To mount the sight bar, place it on the mounting scale plate so that the ends of the click

spring pass through the two slots in the mounting scale plate (Fig. 34). The sight bar assembly is then turned to the required setting. No clicks will be sensed until the index line on the sight body bracket approaches the graduations on the mounting scale plate. To ease turning, lubricate the ends of the click spring. Wipe clean and renew oil daily and after firing.

(c) Zeroing: the M-15 grenade sight is made so that it can be adjusted both vertically and horizontally. When correctly adjusted, the aiming point of the direct fire sights and the point of impact of the grenade are practically the same. The desired range may be obtained by adjusting the sight for a given elevation. With the rifle sight set at zero elevation and windage, place the rifle in a stationary rest and use the "bore-sighting" method to zero the grenade sight. Select a distant aiming point (150 yards or more) and adjust the rifle so that the sights are set on the aiming point. Set the rear sight of the grenade sight at 0 degree elevation by turning the elevating screw sufficient clicks to align the sight body bracket with the top or 0 degree graduation line on the rear of the peep



Fig. 34. Rifle grenade sight M-15, mounting on rifle.

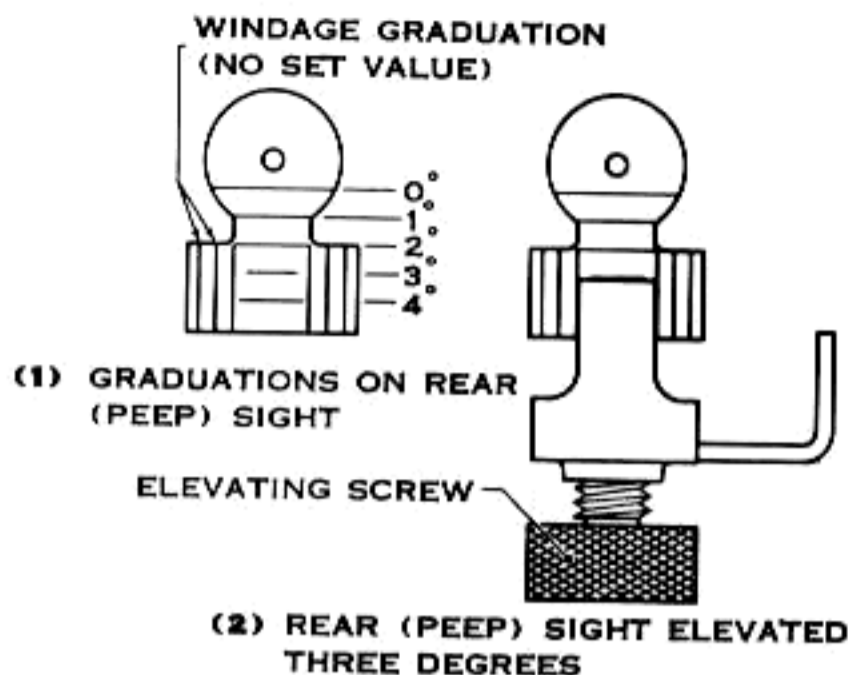

Fig. 35. Rifle grenade sight M15, rear peep sight.

sight and by rotating the sight bar assembly until the index line on the sight body bracket corresponds to the 0 degree setting on the mounting scale plate.

(i) Horizontal adjustment is made by loosening the two sight leaf screws. Move the peep sight the desired distance either to the right or left and then firmly tighten the two sight leaf screws.

(ii) For vertical adjustment, sight through the grenade sight and note whether the sight is pointed above or below the aiming point. Remove the grenade sight bar assembly from the mounting scale plate and loosen the two capscrews on the inside of the sight body bracket. To raise the point of aim of the grenade sight, turn the sight body clockwise in relation to the sight body bracket. To lower the point of aim, turn the sight body counterclockwise in relation to the bracket. Tighten the two capscrews and replace the sight bar assembly on the rifle. Verify the point of aim of the grenade sight. Repeat this process until the grenade sight is set on the same aiming point as the rifle sight.

12. Direct fire from the grenade launchers: Direct fire is any firing done with less than 20 degrees of elevation. In direct fire, the weapon is fired from the shoulder, except in the prone position. This type of fire is effective against point targets such as tanks, pill boxes, or windows of buildings. In direct fire, the grenade must be fully seated on the launcher.

(a) To fire, open the bolt and clear the rifle. Set the safety on lock. Insert the M-3 grenade cartridge into the chamber. Close the bolt. Place

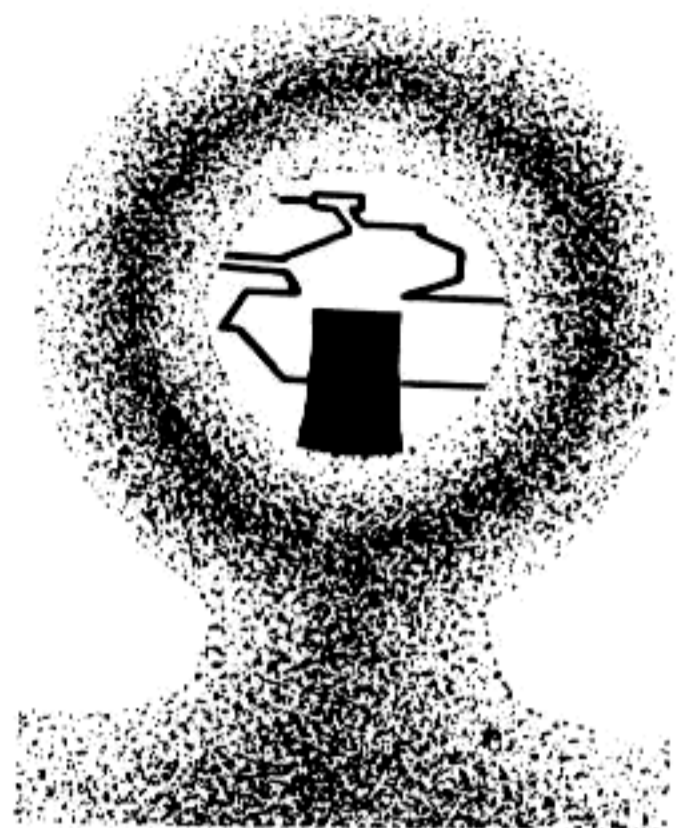

Fig. 36. Correct sight picture, direct fire.

the grenade on the launcher (full). Remove any external safety features (safety pins, etc). Sight, with the eye clear enough of the sight to allow for the violent recoil. Unlock the safety. Fire. The correct sight picture is shown in Fig. 36. Sighting is done much as with conventional rifle sights, except that due to the short sight radius, slight misalignment will cause greater error on target. In low angle, direct fire, the grenade is always seated fully on the launcher, and the only variable is the elevation setting on the sight, and the windage. Firing positions are shown in Fig. 37 and 38.

13. Indirect fire from grenade launchers: Indirect or high-angle fire with rifle grenades is accomplished by placing the butt of the rifle on the

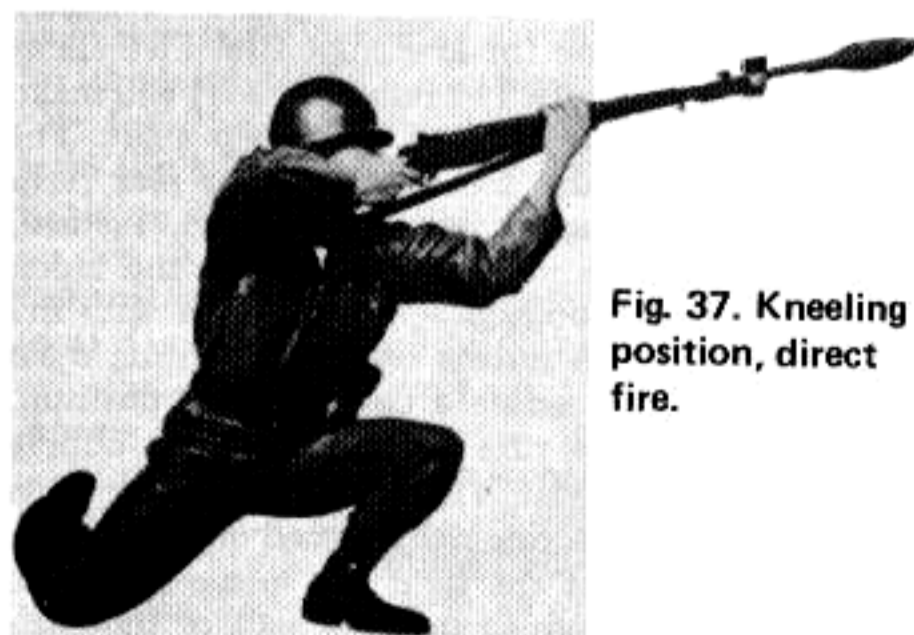

Fig. 37. Kneeling position, direct fire.

THE FIGHTING GARAND



Fig. 38. Standing position, direct fire.

ground and firing at an angle of 25 or more degrees of elevation. Loading and firing is the same as outlined in Para. 12, but in high angle fire one may alter the range of a given grenade at a given elevation, by seating the grenade at different positions on the launcher tube. Instead of sighting through the peep sight, on indirect fire the graduated scale and sighting bubble are used. Correct position for firing is shown in Fig. 39.

(a) High-angle fire is used with rifle grenades to cause casualties among enemy personnel, to fire incendiary missions against inflammable targets, or to perform signaling missions with smoke or pyrotechnic grenades. Due to the inaccuracy of indirect fire, it is often used to engage targets in defilade positions.

14. There are many various types of grenades and pyrotechnic devices which may be launched from the grenade launchers, representative illustrations of which are shown in Fig. 40 to 44.

Section 5, Bayonets

15. For the purposes of in-fighting, prisoner guarding, riot control and similar missions the Garand rifles may be fitted with a bayonet. The Bayonet M1 (Fig. 45) and scabbard M7 were original issue for the Garand rifles, and also fitted the M1903A3 "Springfield" rifles. The Bayonet M1 has an over-all length of 14 7/16 inches, and a blade length of 10 inches. It is fitted by

sliding the muzzle of the rifle through the hole in the top of the hilt, while fitting the retaining lug on the gas cylinder into the slot in the top rear of the handle. It is released by pushing upward on the button on the bottom front of the handle, and withdrawing straight forward.

(a) The Bayonet M5 (Fig. 46) is somewhat shorter than the older M1, and is carried in the bayonet scabbard M8A1 (Fig. 47). It serves also as a general purpose utility knife. The locking device is located at the rear of the grip, and it is squeezed to withdraw the bayonet from the rifle. It is mounted in the same manner as the



Fig. 39. High-angle fire, kneeling position.



Fig. 40. Types of rifle-projected ground signals.

THE FIGHTING GARAND

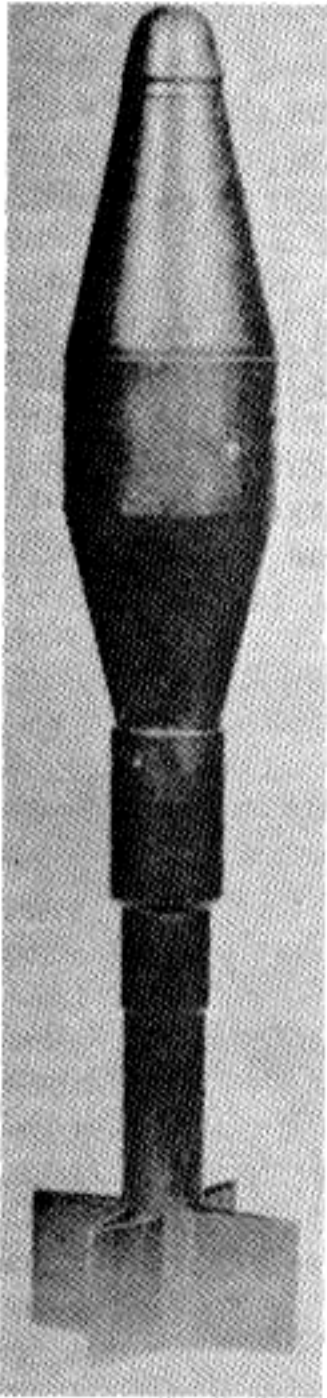

Fig. 41. M31 HEAT grenade.



Fig. 43. M19A1 WP grenade.

Fig. 42. M1A2 grenade adapter.

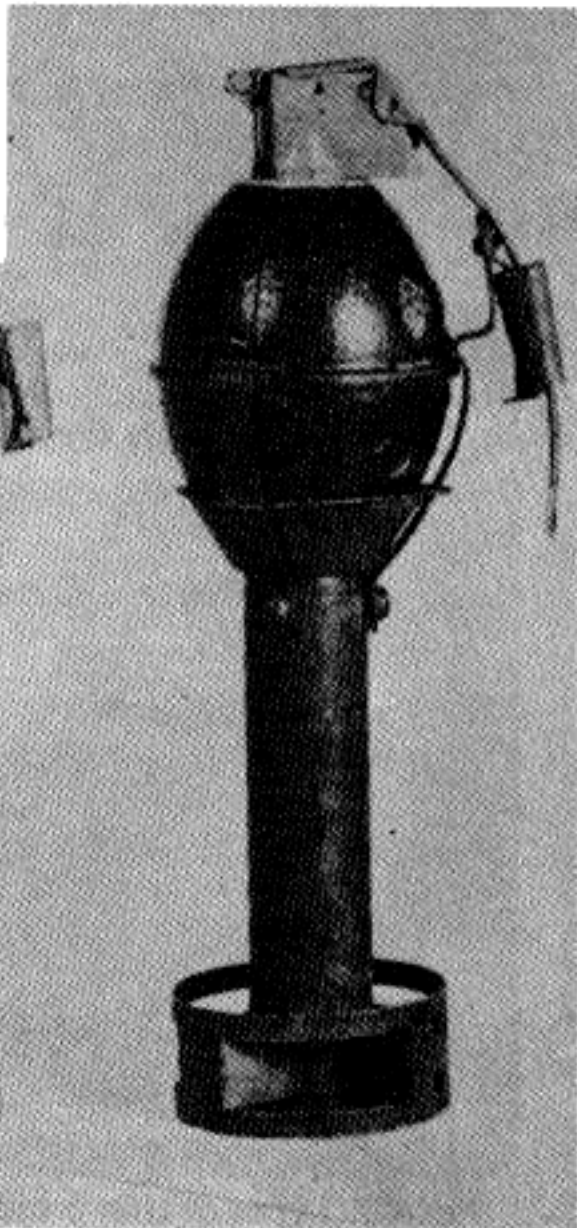

Fig. 44. Colored smoke streamer.

THE FIGHTING GARAND

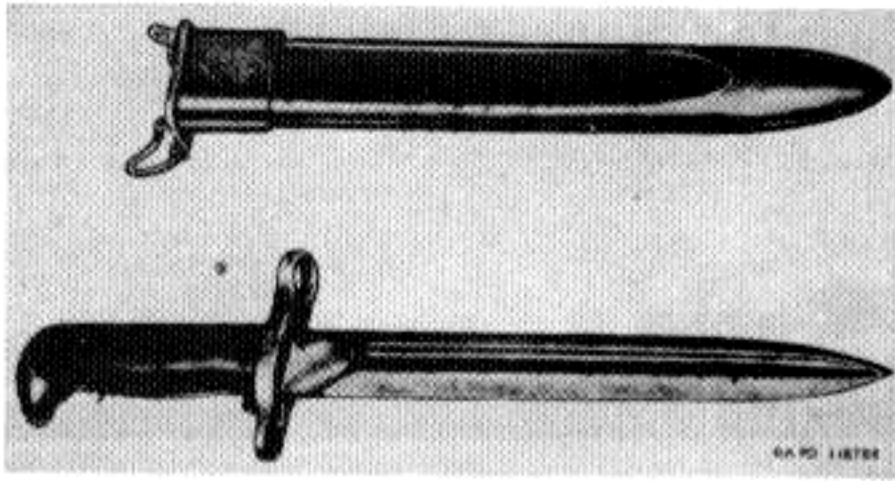

Fig. 45. Bayonet M1 and scabbard M7.

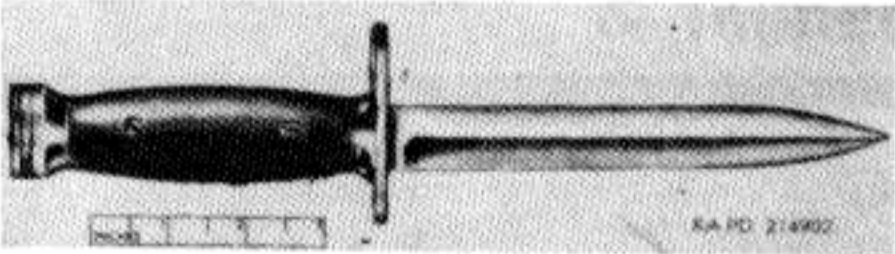

Fig. 46. Bayonet M5.

M1. The bayonet M5 is 11 1/4 inches overall, and has a blade length of 6 3/8 inches.

(b) The Bayonet-knife M5-1 (Fig. 47) is the most recent issue bayonet for the Garand. It

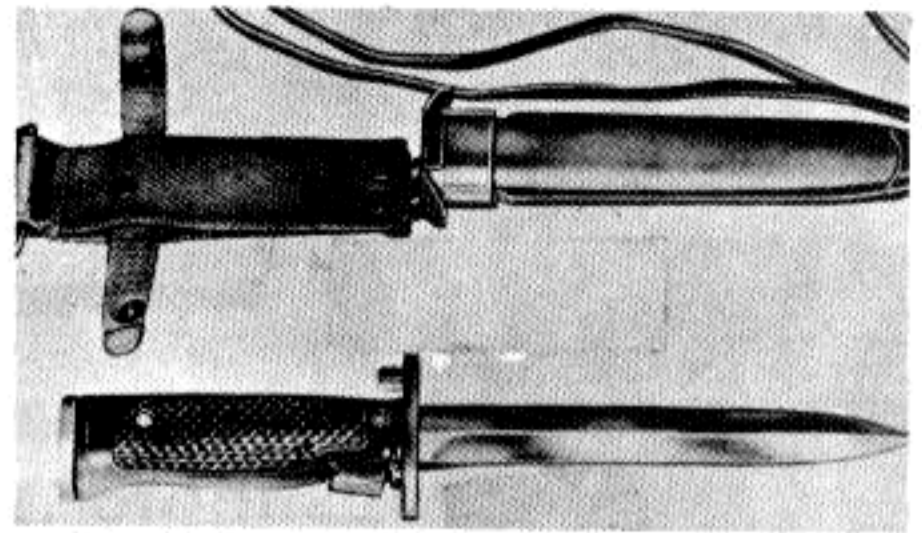

Fig. 47. Bayonet M5-1 and scabbard M8A1.

is slightly longer than the M5 (blade length of 6 5/8 inches, over-all length of 11 1/4 inches), and has a different locking mechanism. To mount the M5-1 on the rifle, fit the lug on the rear of the hilt into the gas cylinder locking screw, while fitting the lug on the gas cylinder into the slot on the rear of the handle. To remove the M5-1 from the rifle, push up on the release on the bottom front of the handle, and withdraw straight to the front.



III. Functioning, Stoppages & Immediate Action

Section 1, Functioning

16. On all standard models of the Garand rifles, the trigger must be pulled to fire each round. Each time a round is loaded and fired, many parts inside the rifle work in a given order. This is known as the "cycle of operation". This cycle is similar in most semi-automatic weapons. A knowledge of what happens inside the rifle during this cycle of operation will help you to understand the cause and remedy for various stoppages.

(a) Feeding: feeding takes place when a round is moved into the path of the bolt. This is done by the follower assembly exerting an upward pressure on the bottom round in the clip. The follower assembly is continuously forced up by the pressure of the operating rod spring through the follower rod and follower arm (Fig. 48).

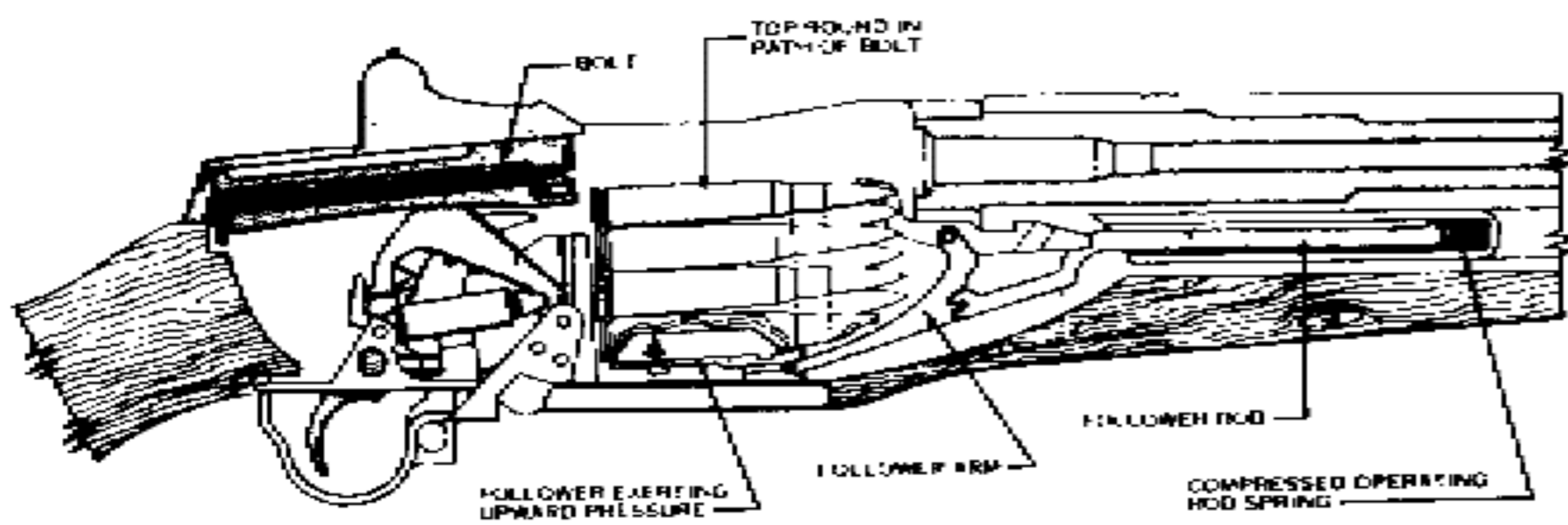

Fig. 48. Position of parts, bolt in rearmost position.

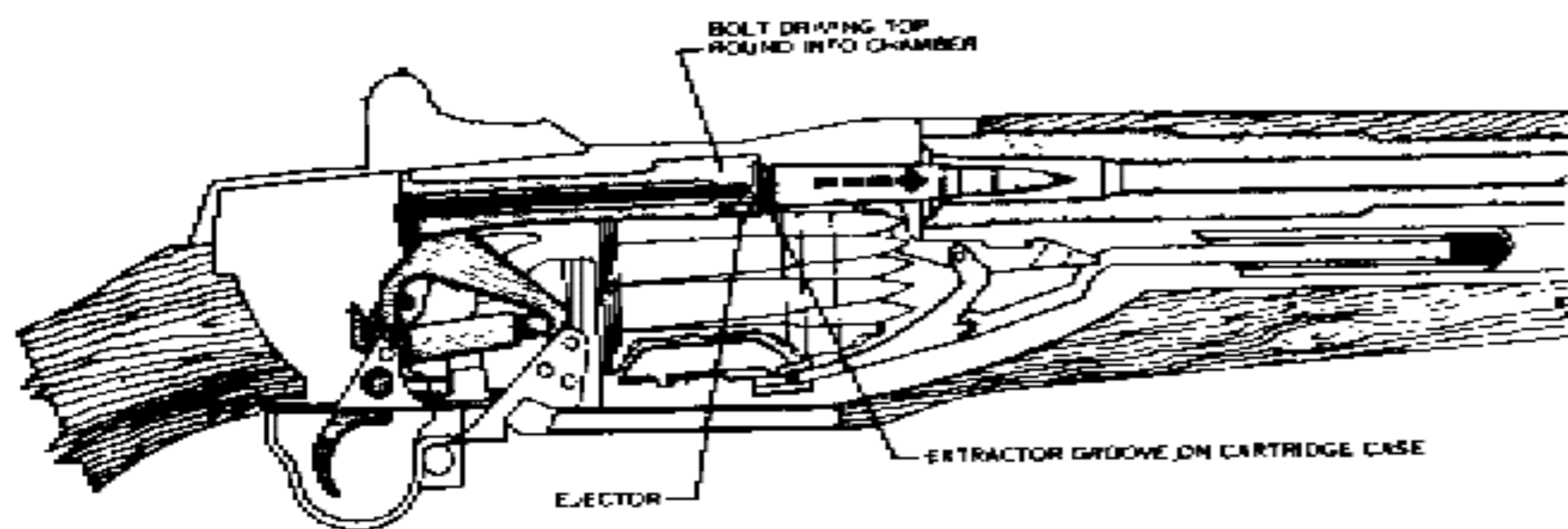

Fig. 49. Chambering.

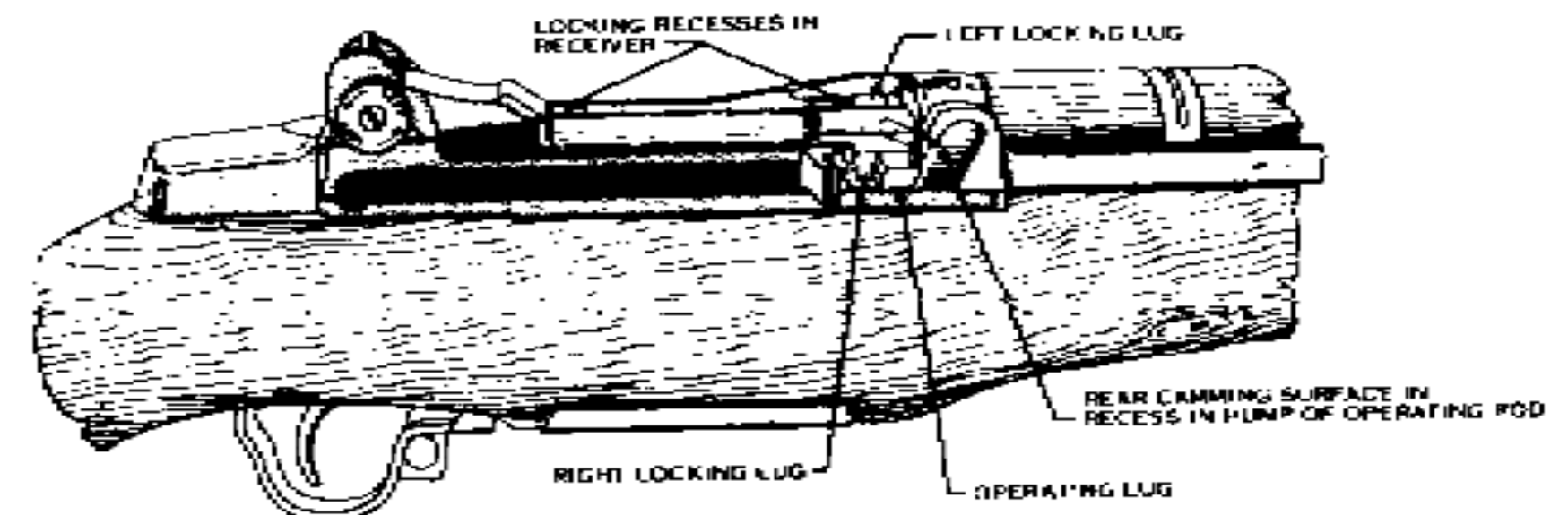

Fig. 50. Locking.

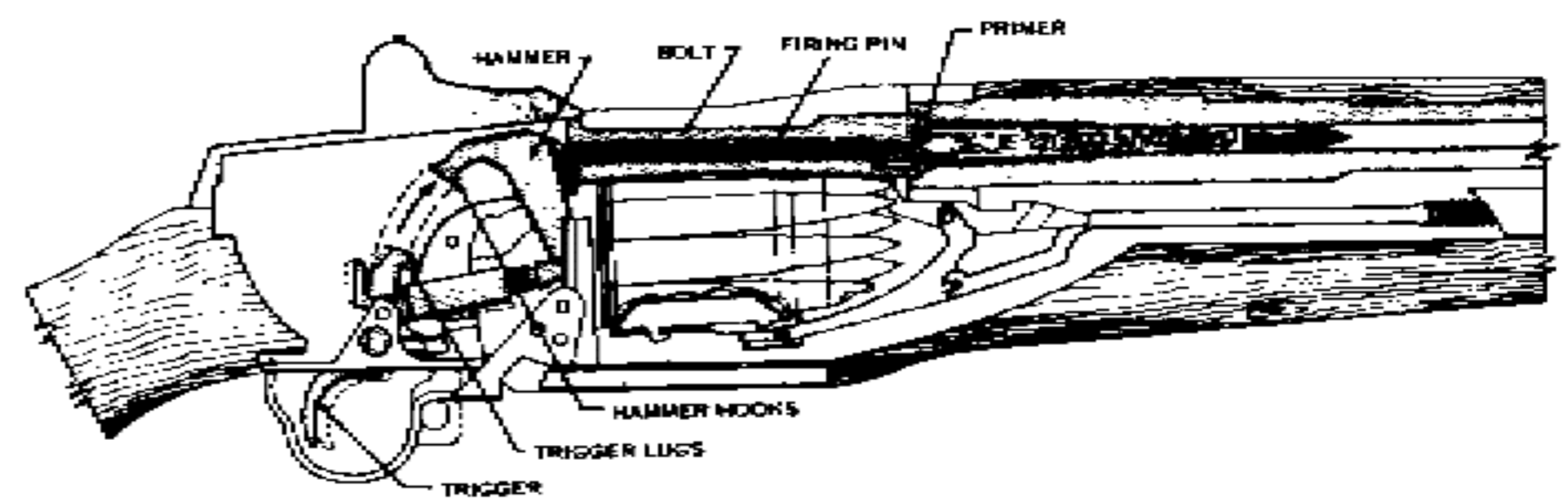

Fig. 51. Firing.

(b) Chambering: chambering occurs when a round is moved into the chamber. This takes place as the bolt goes forward under pressure of the expanding operating rod spring, picking up the top round in the clip and driving it forward into the chamber (Fig. 49). Chambering is complete when the extractor snaps into the extracting groove on the cartridge case and the ejector is forced into the face of the bolt.

(c) Locking: locking is complete when the bolt is fully closed. This prevents the loss of gas pressure until the bullet has left the muzzle. The bolt is locked by the rear camming surface in the recess in the hump of the operating rod, forcing the operating lug of the bolt down. This engages the locking lugs on the bolt with the recess in the receiver (Fig. 50).

(d) Firing: firing occurs when the firing pin strikes the primer. As the trigger is pulled the

THE FIGHTING GARAND

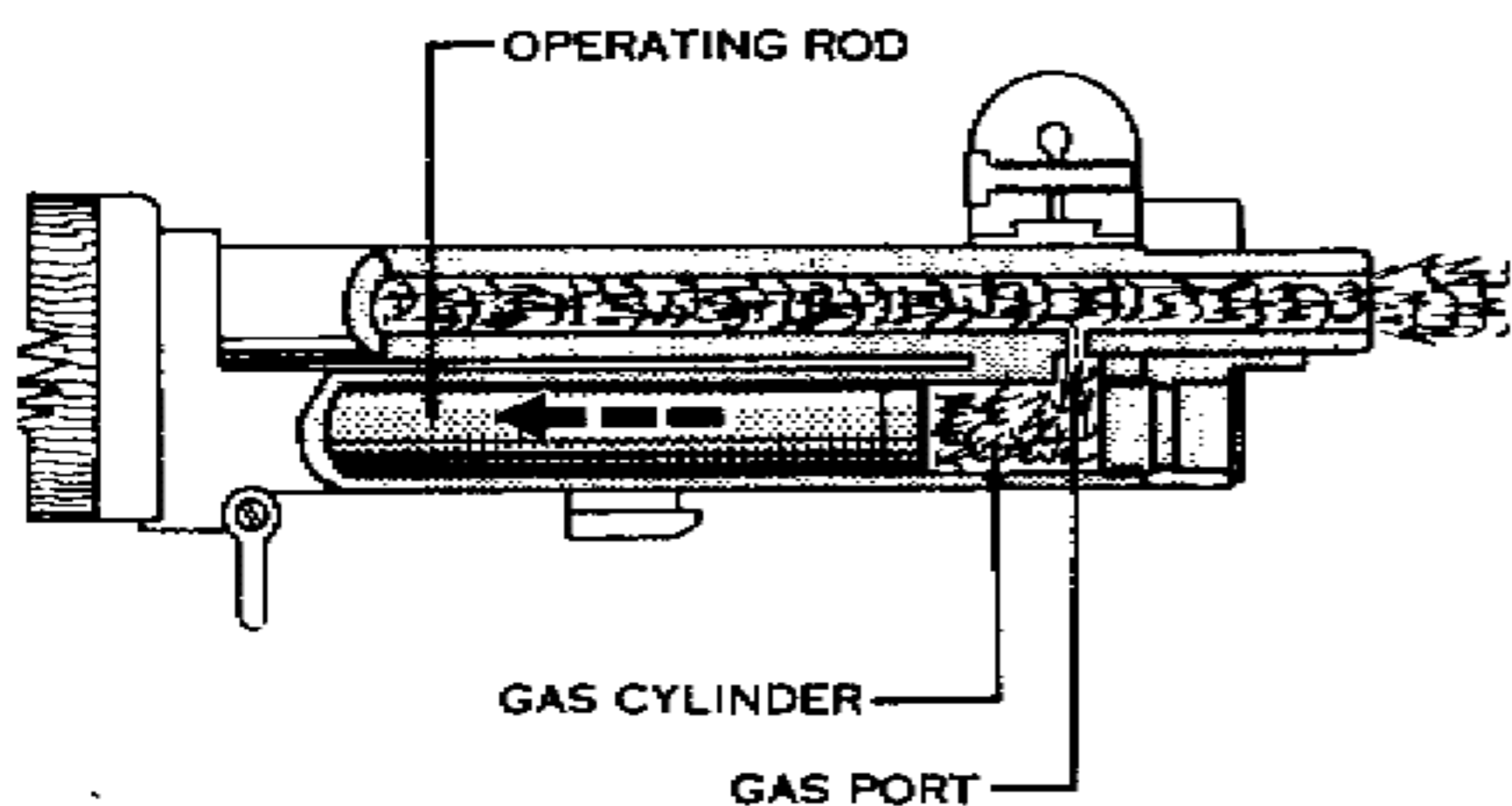

Fig. 52. Action of the gas.

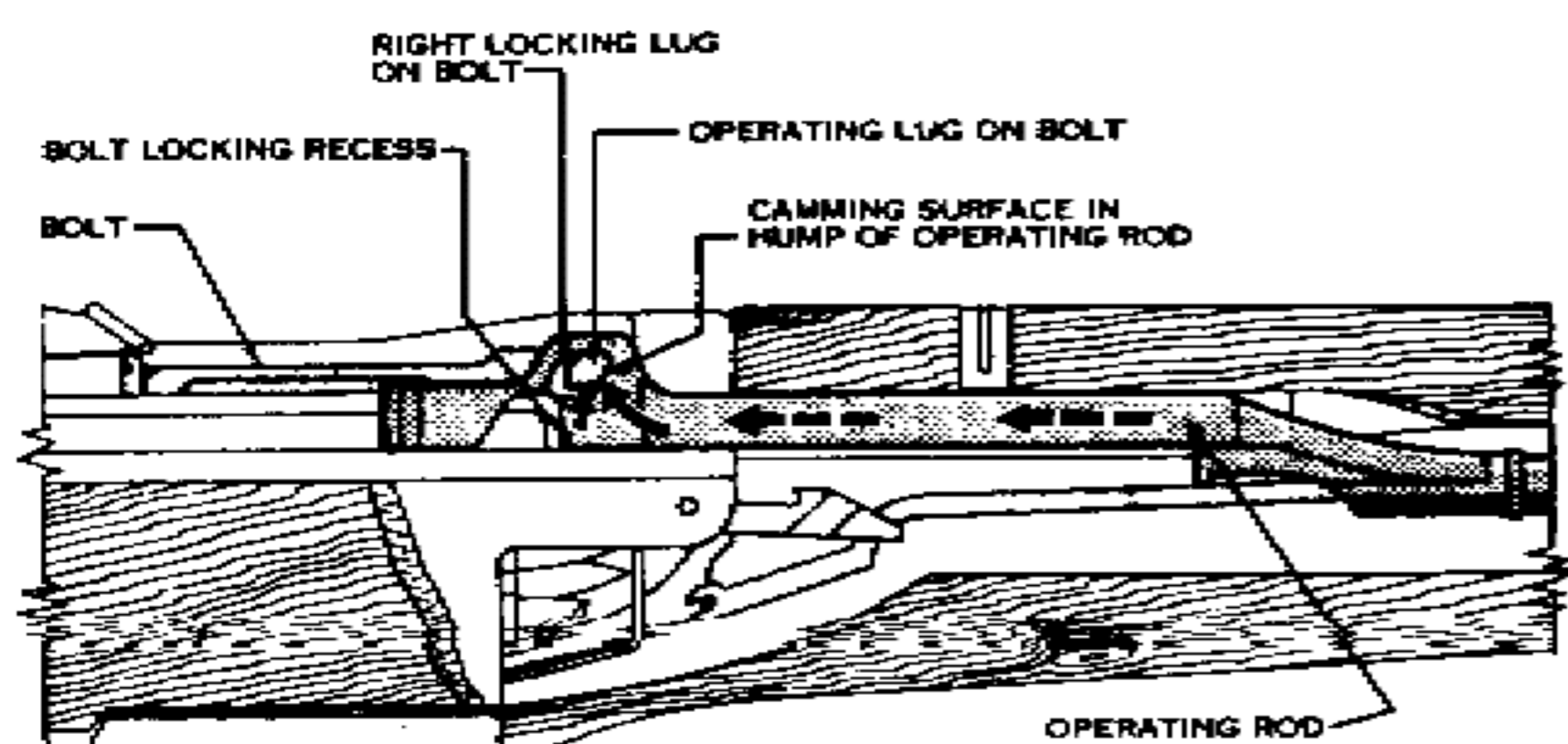

Fig. 53. Unlocking.

trigger lugs are disengaged from the hammer hooks and the hammer is released. The hammer moves forward under the pressure of the hammer spring and strikes the tang of the firing pin, driving the firing pin against the primer and firing the round (Fig. 51).

(e) Unlocking: unlocking occurs after the firing of the round. As the bullet is forced through the barrel by the expanding gas, a small portion of the gas escapes through the gas port into the gas cylinder, forcing the operating rod to the rear (Fig. 52). The camming surface inside the recess in the hump of the operating rod forces the operating lug of the bolt upward, disengaging the locking lugs from their recess in the receiver. The bolt is thus unlocked and ready to be moved to the rear (Fig. 53).

(f) Extracting: extracting is pulling the empty case from the chamber. The extractor, which is engaged with the extracting groove on the cartridge case, withdraws the empty case as the bolt moves to the rear (Fig. 54).

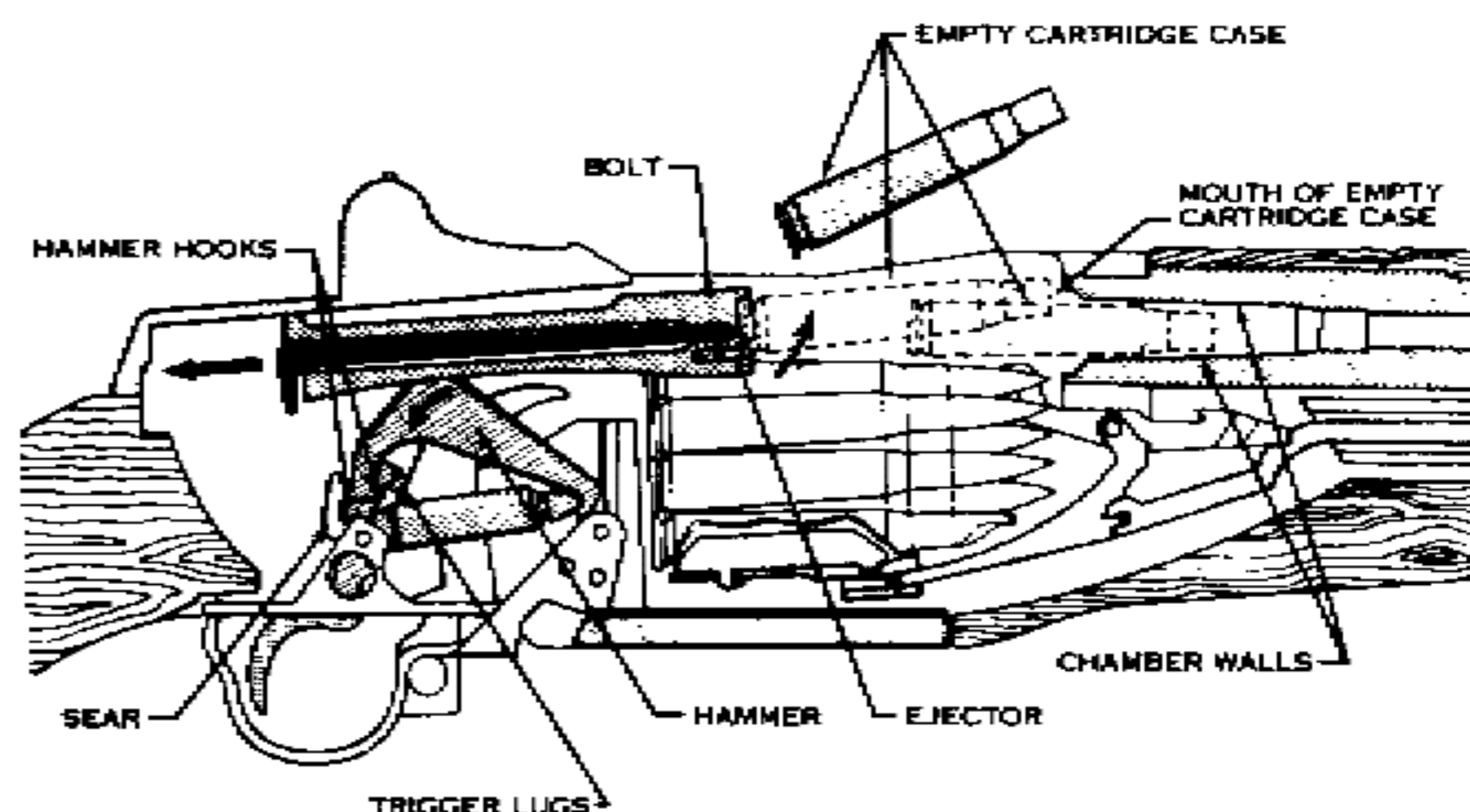

Fig. 55. Ejecting and cocking.

(g) Ejecting: ejecting is throwing the empty case from the rifle. As the bolt moves to the rear, withdrawing the case from the chamber, the round is held in place by the chamber walls. When the mouth of the empty case clears the chamber, it is ejected up and to the right by the expanding ejector spring and ejector (Fig. 55).

(h) Cocking: cocking occurs when the hammer is forced into the proper position for firing the next round. This happens as the bolt continues to the rear. The rear end of the bolt forces the hammer back and rides over it. The hammer is caught by the sear if the trigger is still held to the rear, but it is caught by the trigger lugs if trigger pressure has been released (Fig. 55).

Section 2, Stoppages and Immediate Action

17. Stoppages:

(a) A stoppage is any unintentional interruption in the cycle of operation.

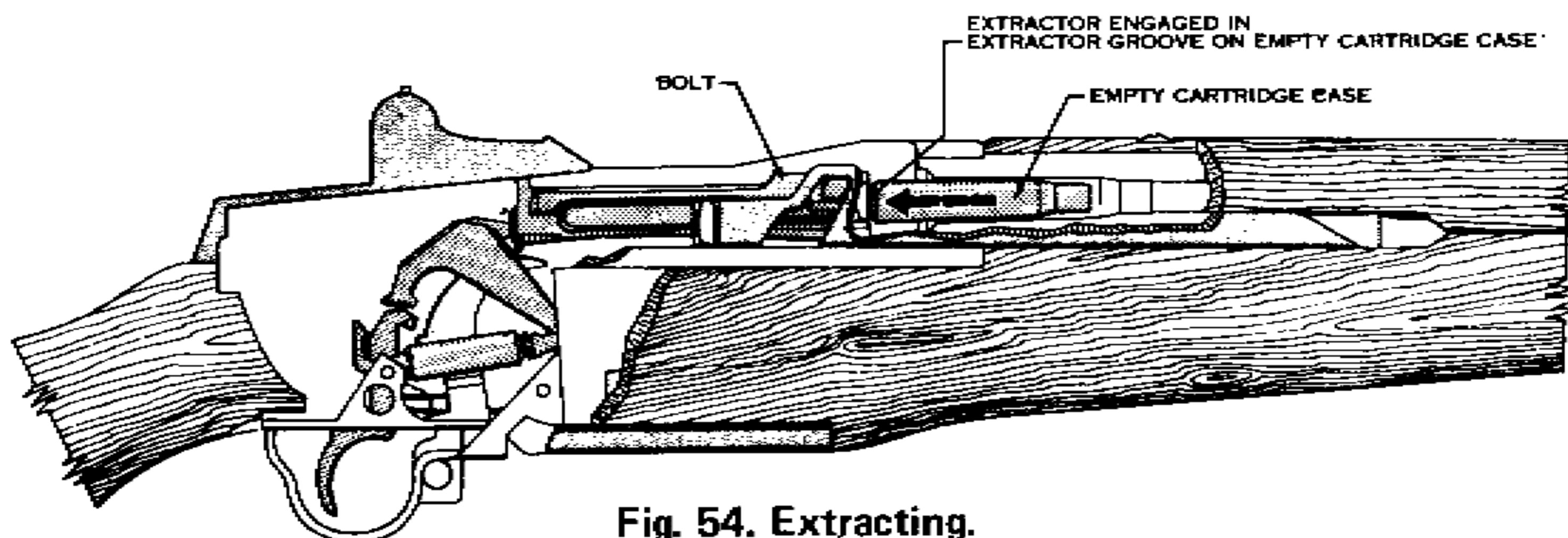

Fig. 54. Extracting.

THE FIGHTING GARAND

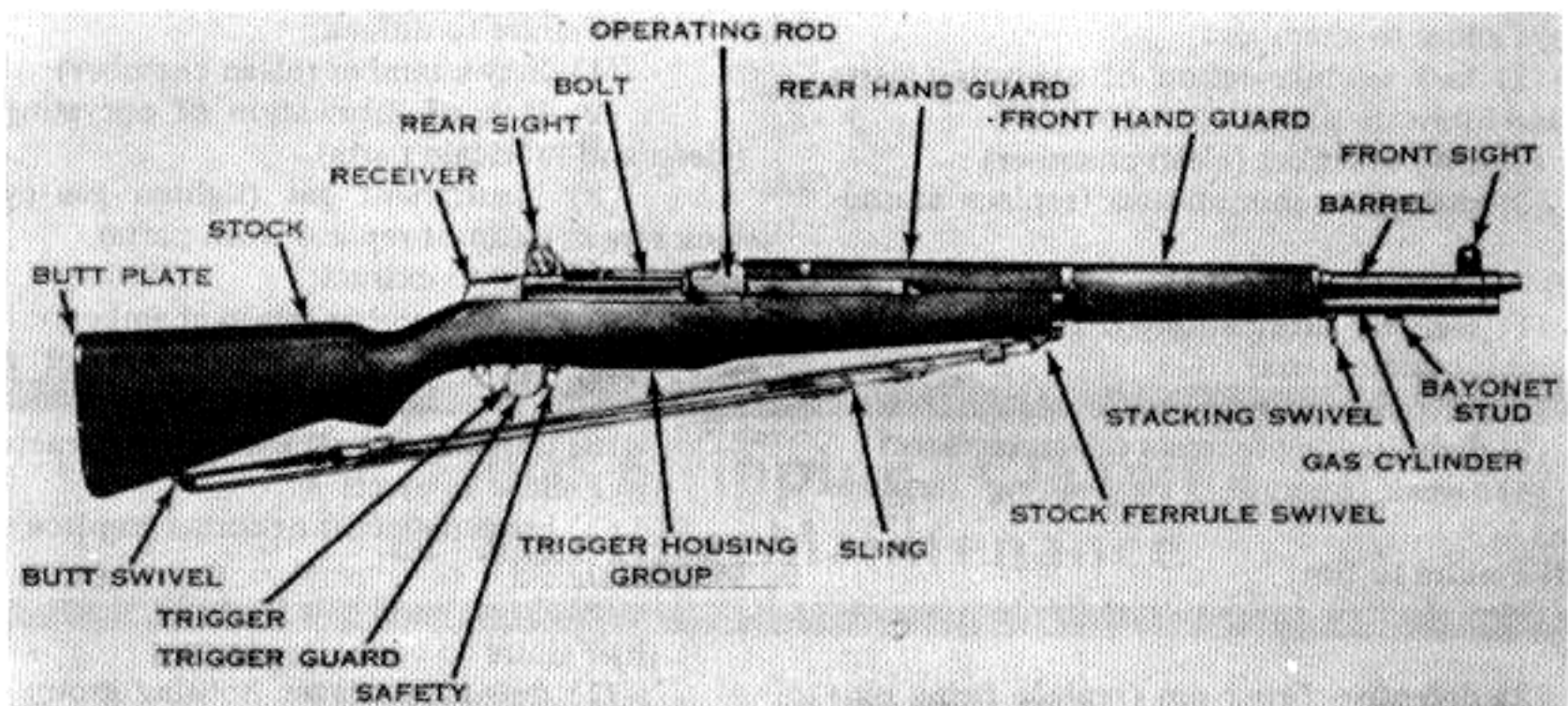

Fig. 56. Nomenclature of the M1 rifle.

(b) Most stoppages occur because of dirty, worn, or broken parts, and lack of lubrication. These defects should be observed and corrective action taken to eliminate them before they cause a stoppage.

18. Immediate action:

(a) Immediate action is the prompt action taken by the rifleman to reduce a stoppage. To apply immediate action on the Garand rifles, pull the operating rod handle all the way to the rear with the right hand, PALM UP, then release it. The hand is held palm up to prevent injury should there be a hangfire which ignites as the action is opened. Next, aim the rifle and attempt to fire it.

(b) If immediate action is applied quickly and properly when the rifle fails to fire, most stoppages will be reduced.

19. Misfire, Hangfire, and Cookoff:

(a) With modern ammunition, hangfires and misfires rarely occur. Normally, the rifleman will apply immediate action which in most instances reduces the stoppage when caused by a hangfire or misfire.

(b) Misfires are caused by one of three factors - the firer, the weapon malfunctioning (due to excessive dirt, etc.), or faulty ammunition. When many rounds have been fired and the barrel is hot, danger of the round "cooking off" or igniting from the barrel heat exists. For this reason, immediate action should be applied when a round does not fire to clear the ammunition from the chamber. When a hangfire ignites after

it has been ejected from the weapon, it is relatively harmless.

20. Malfunctions: A malfunction is a failure of the weapon to operate satisfactorily. Some of the reasons are:

(a) The clip may jump out on the seventh round. This is caused usually by a bent follower arm or bullet guide and can be corrected by replacing them.

(b) The rifle may fire in bursts of two or three rounds. This is due to the sear being broken, worn or remaining in an open position. It can usually be corrected by replacing the sear, or under field conditions, replacing the trigger housing group.

(c) The safety may release when pressure is applied to the trigger. This can be caused by a broken safety or by the trigger stop on the safety being worn. It can be corrected by replacing the safety.

(d) Operating parts which fail to move fully to the rear (short recoil) are caused by:

- (1) valve leak in gas cylinder lock screw (screw valve not fully seated)
- (2) defective operating rod spring
- (3) undersized piston (caused by the use of abrasives when cleaning the piston).

21. Stoppages, their causes and remedies:

- (a) Failure to feed:
- (1) lack of lubrication on operating parts (clean and lubricate parts)
 - (2) defective or worn parts (replace parts)
 - (3) short recoil (see para. 20, d.).

THE FIGHTING GARAND

(b) Failure to chamber:

- (1) lack of lubrication of operating parts (clean and lubricate parts)
- (2) dirty chamber (clean chamber)
- (3) defective ammunition (replace ammunition).

(c) Failure to lock:

- (1) lack of lubrication of operating parts (clean and lubricate parts)
- (2) dirty chamber (clean chamber)
- (3) dirty locking recesses (clean recesses)
- (4) weak operating rod spring (replace spring).

(d) Failure to fire:

- (1) defective ammunition (replace ammunition)
- (2) defective firing pin (replace firing pin)
- (3) defective trigger housing group (repair trigger group).

(e) Failure to unlock:

- (1) dirty chamber (clean chamber)
- (2) lack of lubrication of operating parts (clean and lubricate parts)
- (3) insufficient gas (tighten gas cylinder lock screw, clean or replace worn parts).

(f) Failure to extract:

- (1) dirty chamber (clean chamber)
- (2) dirty ammunition (clean or replace ammunition)
- (3) broken extractor (replace extractor).

(g) Failure to eject:

- (1) broken ejector or spring (replace ejector or spring)
- (2) short recoil (see para. 20, d.).

(h) Failure to cock:

- (1) defective trigger housing group (repair trigger housing group)
- (2) short recoil (see para. 20, d.).



IV. Field Stripping, Cleaning & Routine Maintenance

Section 1, Field Stripping

22. The rifle should be disassembled and assembled only when maintenance is required, or for cleaning. Repeated disassembly and assembly causes excessive wear of parts, and will eventually make them unserviceable, and reduces the accuracy of the weapon.

(a) The Garand rifles M1, M1C and M1D are designed so that they may be easily disassembled and assembled. No force is needed if they are disassembled and assembled correctly. The parts of the various rifles may be interchanged and function satisfactorily, with the exception of the bolt, but if gas cylinders, pistons and gas cylinder locking screws are changed, it will tend to alter the zero of a given rifle.

(b) As the rifle is disassembled, the parts should be laid out on a clean surface, in order

of removal, from left to right. This makes assembly easier because the parts are assembled in the reverse order of disassembly.

(c) The first step in stripping the rifle, is to clear it. To clear the rifle, unload it as shown in Para. 5, pull the slide all the way to the rear, inspect the chamber, allow the bolt and slide to go forward, and pull the trigger.

23. Disassembly into the three main groups:

(a) The three main groups are the trigger housing group, the barrel and receiver group, and the stock group (Fig. 57).

(b) To disassemble the rifle into the three groups, place the butt against the left thigh, sights to the left. With the thumb and forefinger of the right hand, pull downward and outward on the rear of the trigger guard. Swing the trigger guard out as far as it will go and lift the trigger housing



Fig. 57. The three main groups.



Fig. 58. Removing the trigger housing group.

assembly out (Fig. 58). The rifle should be left cocked for disassembly into the three main groups. In older models, the trigger guard is machined, and some are quite stiff. If difficulty is experienced in unsnapping the rear of the trigger guard from the trigger housing, insert a cleaning rod through the hole in the back of the trigger guard, and use both hands to pull downward and outward.

(c) To separate the barrel and receiver from the stock, lay the weapon on a flat surface with the sights up, muzzle to the left. With the left hand, grasp the rear of the receiver and raise the rifle. With the right hand, give a downward blow, grasping the small of the stock. This will separate the stock group from the barrel and receiver group. (Fig. 59).

24. Disassembly of the Barrel and Receiver and Trigger Housing Groups:

(a) Place the barrel and receiver, with the bolt closed, on a flat surface with the sights down (insuring that the aperture is at its lowest possible position), muzzle pointing to the left. Holding the rear of the receiver with the right hand, grasp the follower rod with the thumb and forefinger of the left hand and disengage it from the follower arm by moving it toward the muzzle (Fig. 60). Remove the follower rod and operating rod spring by withdrawing them to the right. It is not necessary to separate these parts.

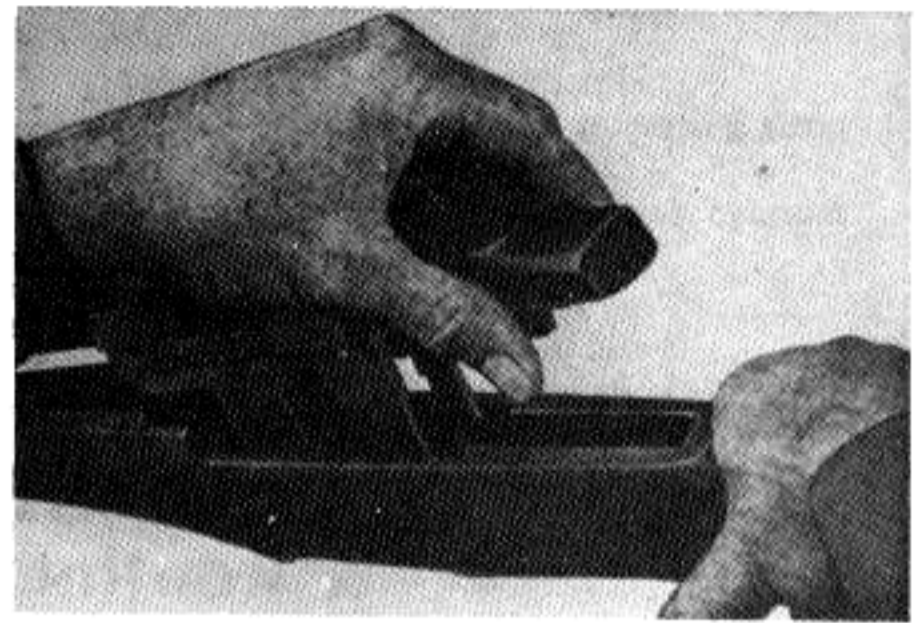

Fig. 59. Removing the barrel and receiver assembly from the stock assembly.

(b) Using the tip of a cartridge or a cleaning tool, remove the follower arm pin by pushing it from the far side of the receiver toward the body (Fig. 61.)

(c) With the left hand, grasp the bullet guide, follower arm, and operating rod catch assembly, and lift them out of the receiver together (Fig. 62). Separate and arrange these parts from left to right in the following order: follower arm, operating rod catch assembly, and bullet guide.

(d) Reach down into the receiver and lift out the follower assembly.

(e) Turn the barrel and receiver group over so that the sights are up, muzzle pointing away from you. With the left hand, raise the rear of the receiver. With the right hand, pull the operating rod to the rear until the rear of the handle is directly under the forward edge of the windage knob. With an upward and outward movement, disengage the guide lug of the operating rod through its dismount

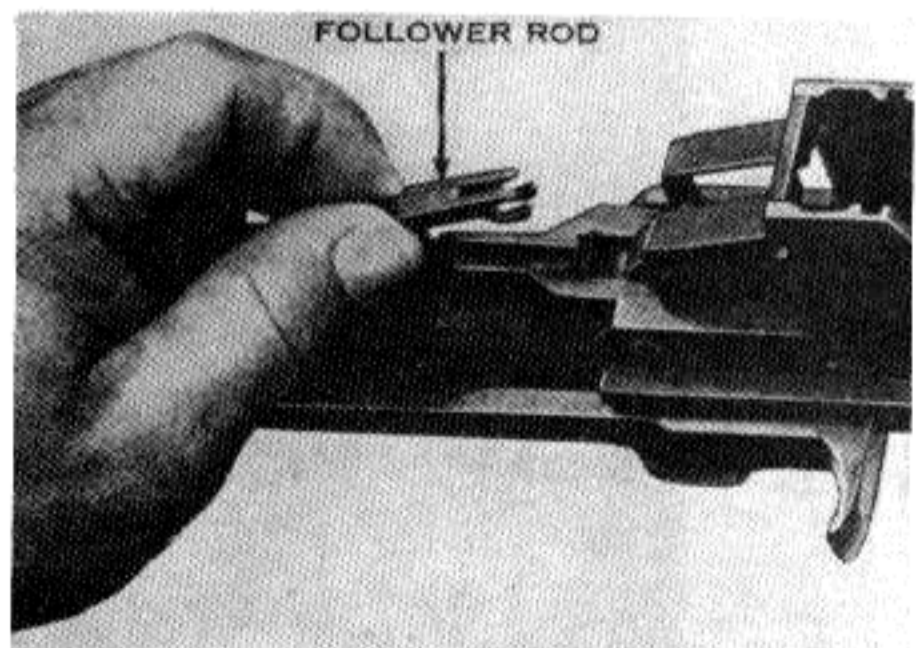

Fig. 60. Removing the follower rod and operating rod spring.

THE FIGHTING GARAND

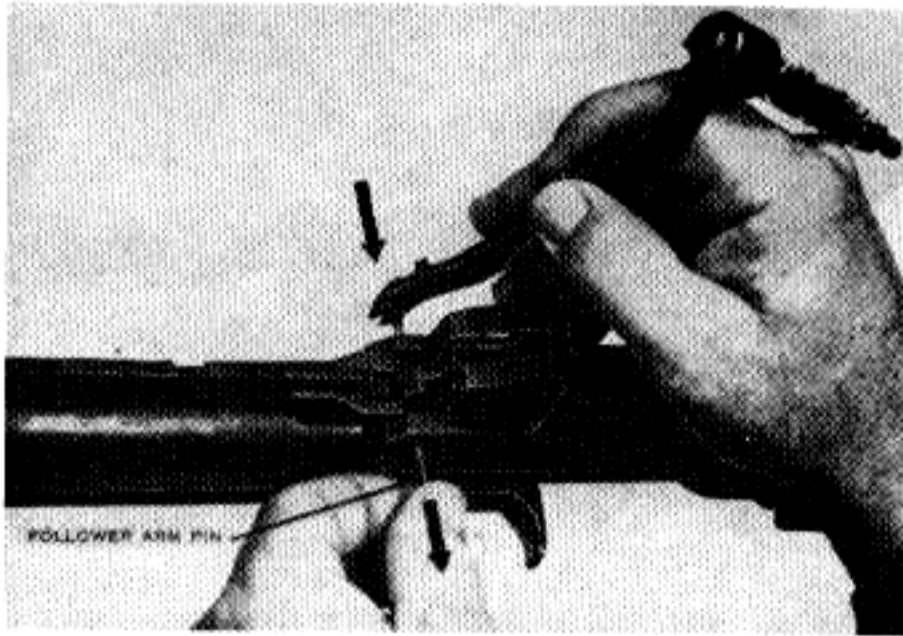

Fig. 61. Removing the follower arm pin.

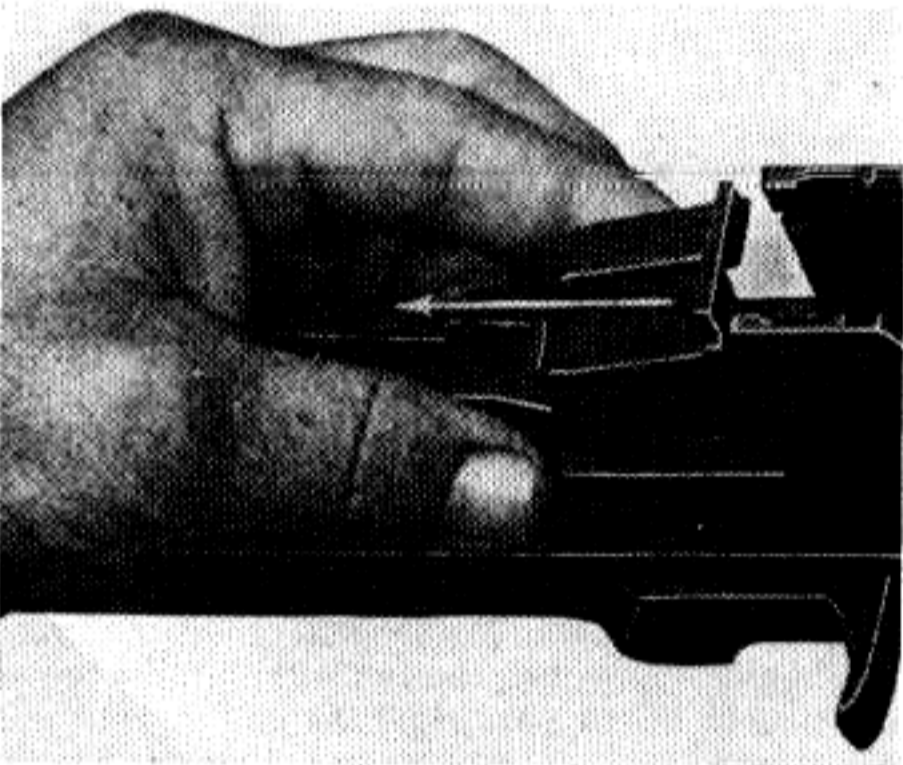

Fig. 62. Removing the bullet guide, follower arm & operating rod catch.

notch on the receiver. Remove the operating rod (Fig. 64). **CAUTION:** the operating rod is bent intentionally so that it will not bind against the enlarged portion of the barrel. Do not attempt to straighten it!

(f) With the right hand, grasp the bolt by the operating lug and slide it fully to the rear; then slide it forward, lifting upward and outward to the right front with a slight rotating motion to remove it.

(1) To detail strip the bolt, hold the bolt in your left hand. Place the blade of a combination tool or a screw driver between the extractor and the lower cartridge seat flange (Fig. 65). With your left thumb over the extractor, twist the blade against the extractor and unseat it. The ejector will snap up against your left thumb. Remove the

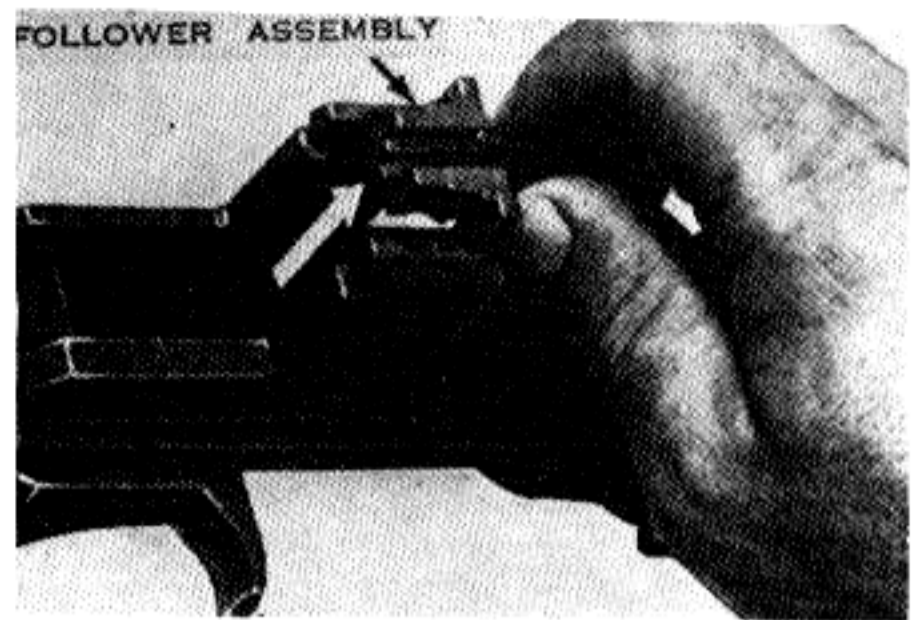

Fig. 63. Removing the follower.

extractor and the extractor spring and plunger. Lift out the ejector and spring. Do not separate the ejector from its spring, nor the extractor plunger from its spring (Fig. 66).

(2) Remove the firing pin from the rear of the bolt.

(3) The bolt may be disassembled without being removed from the rifle to replace a broken

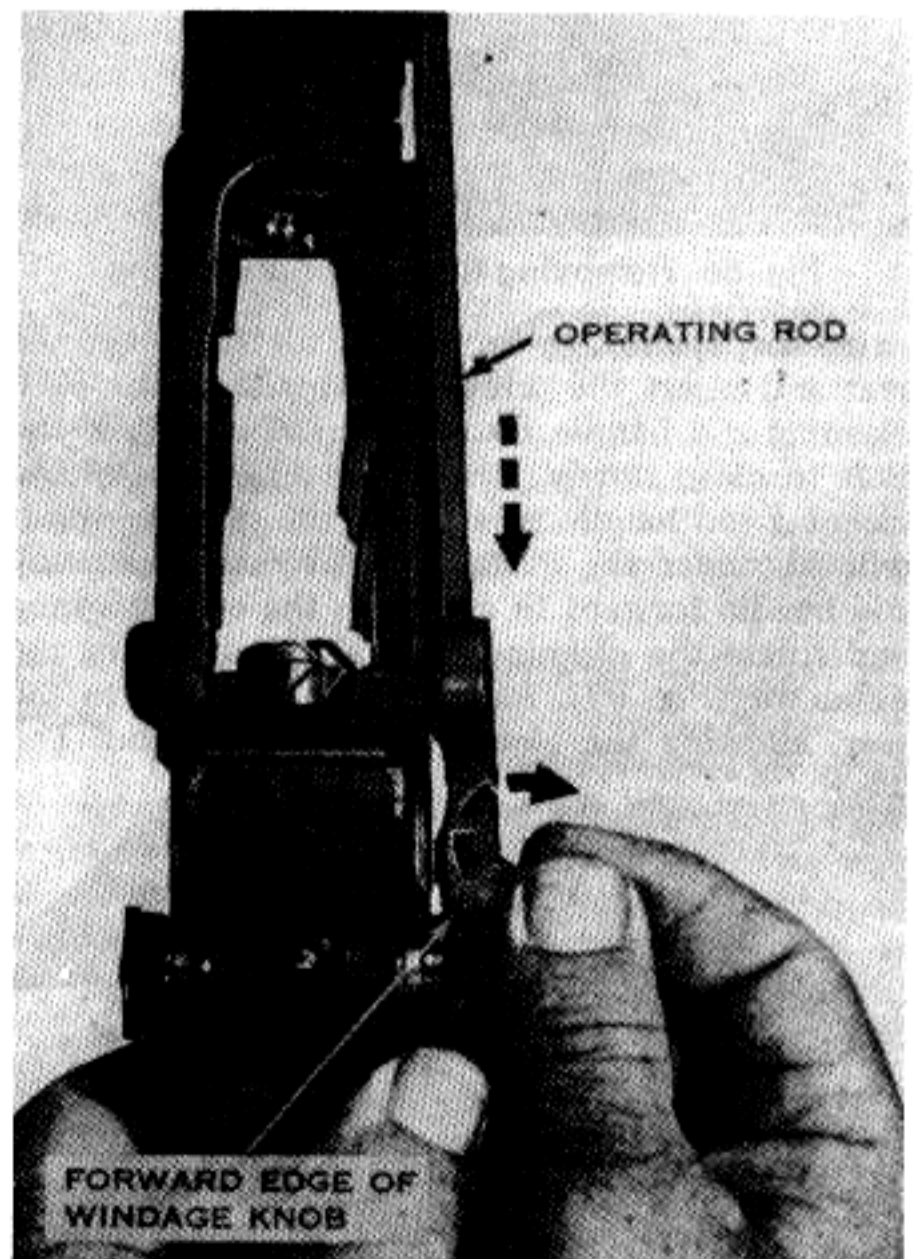

Fig. 64. Removing the operating rod.

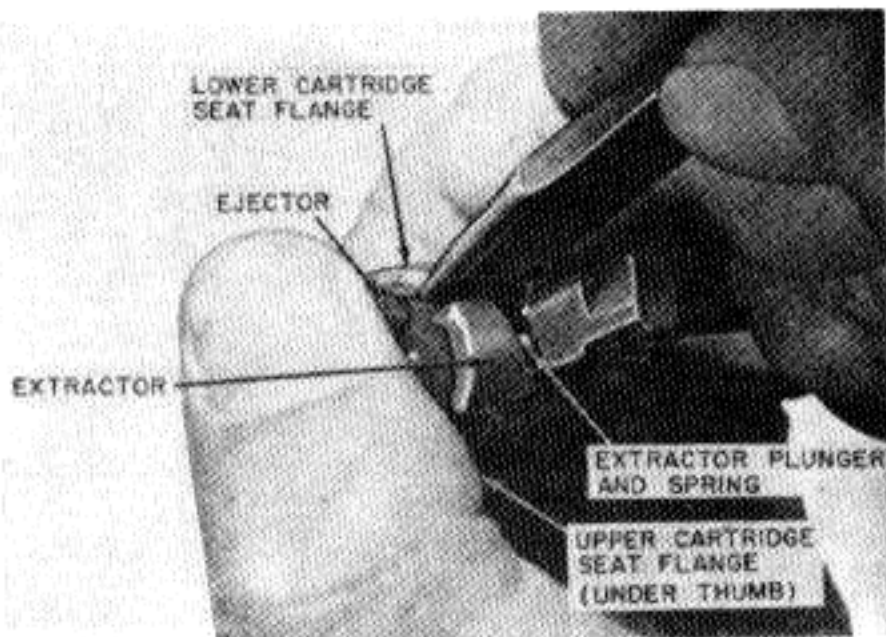

Fig. 65. Unseating the extractor.

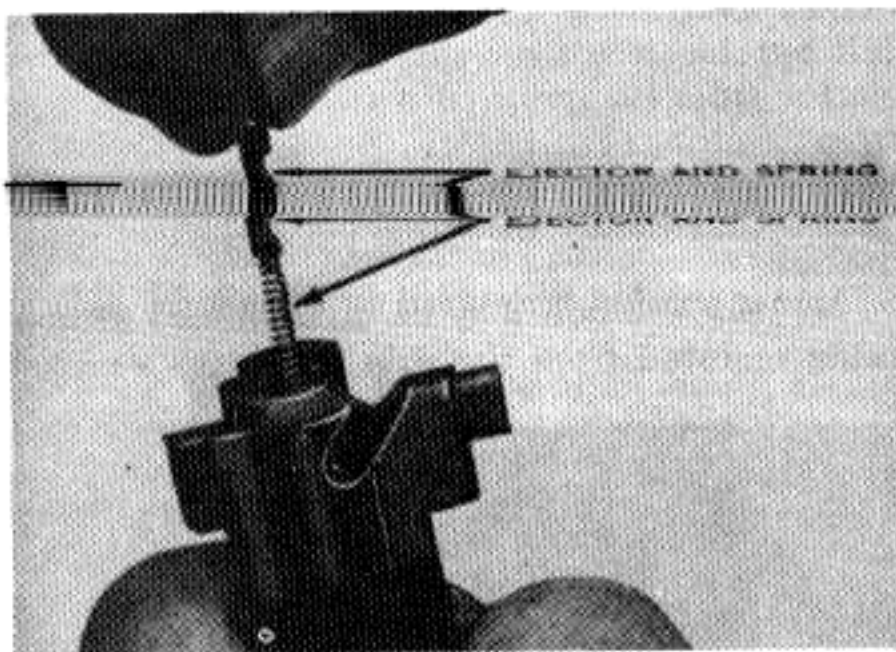

Fig. 66. Removing the ejector and spring.

extractor, ejector, or firing pin. Pull the bolt to the rear and insert the screwdriver blade of the M10 cleaning rod handle into the chamber. Allow the bolt to close slowly. The protruding blade of the cleaning rod handle must be to the right so that it will fit under the extractor. Force the operating rod handle forward to compress the ejector spring and rotate the cleaning rod handle, unseating the extractor (Fig. 67). Slowly move the bolt to the rear, allowing the ejector spring to expand. The

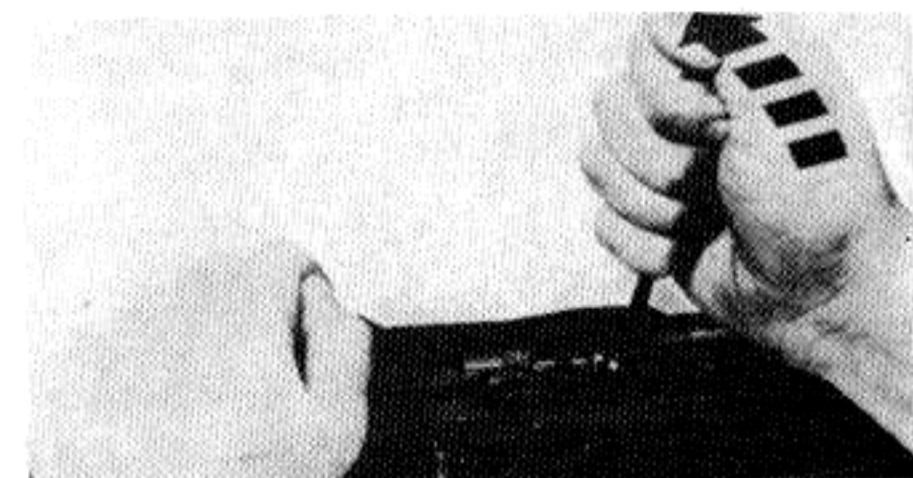

Fig. 67. Disassembling bolt in rifle.

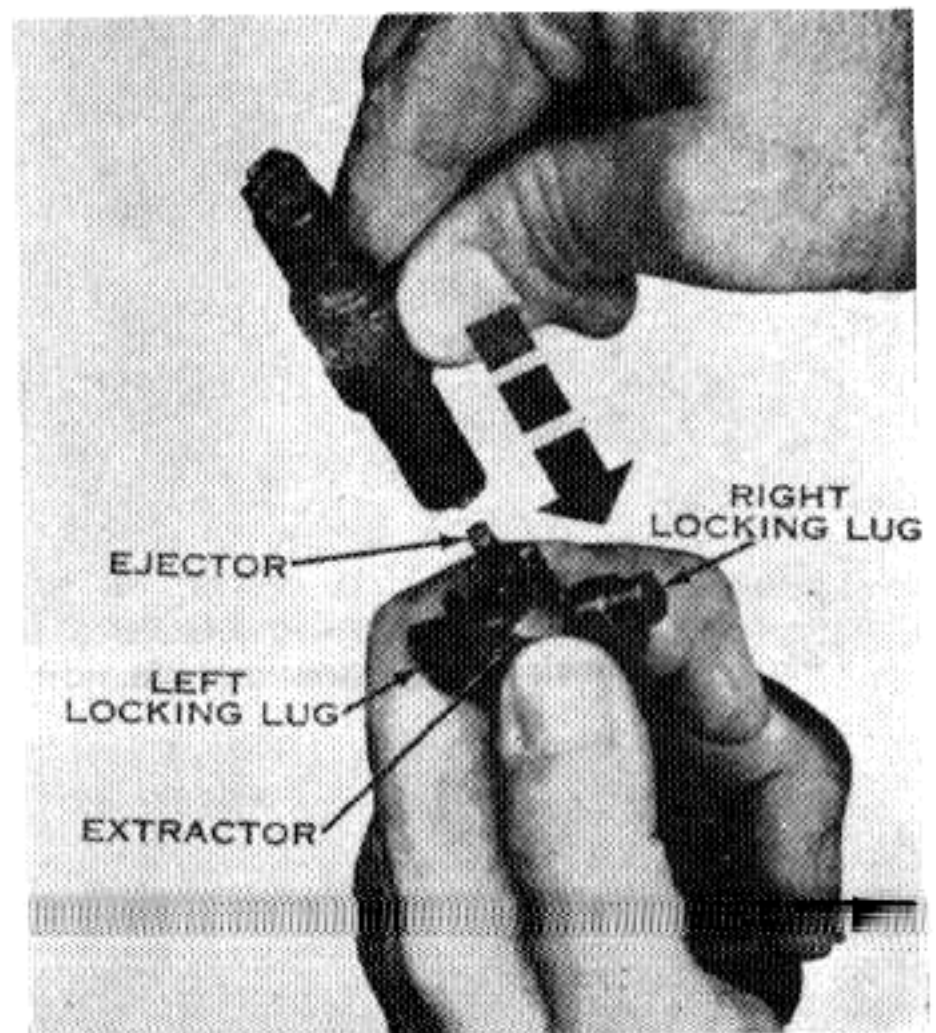

Fig. 68. Assembling the bolt.

extractor and ejector can then be removed. (If it is necessary to remove the firing pin, the barrel and receiver group must be separated from the stock group. Then, after the extractor and ejector have been removed, the firing pin will fall out to the rear if the barrel is tilted up.)

(4) To assemble the bolt, insert the firing pin, making sure that the tang fits into its recess in the rear of the bolt. Hold the bolt in your left hand with the face up, the operating lug to the right, and with the rear end on a solid surface. Replace the ejector and the ejector spring so that the cut on the ejector is toward the operating lug. Replace the extractor spring and plunger. Place the stud of the extractor into its hold in the bolt and press lightly on the extractor with the left thumb until it begins to ride over the extractor plunger. Place the disassembling and assembling end of the M10 cleaning rod handle (or the tip of a cartridge) so that the cutout portion will fit over the ejector and the blade is positioned to line up between the bottom of the extractor and the lower cartridge seat flange (Fig. 68). Press downward on the cleaning rod handle until the ejector is forced into the face of the bolt, and at the same time, press inward on the extractor with your left thumb, seating it.

(5) To assemble the bolt while it is in the rifle, replace the parts as described in (4), above. Place the screwdriver blade end of the M10 clean-

THE FIGHTING GARAND

Fig. 69. Parts of old rear sight.

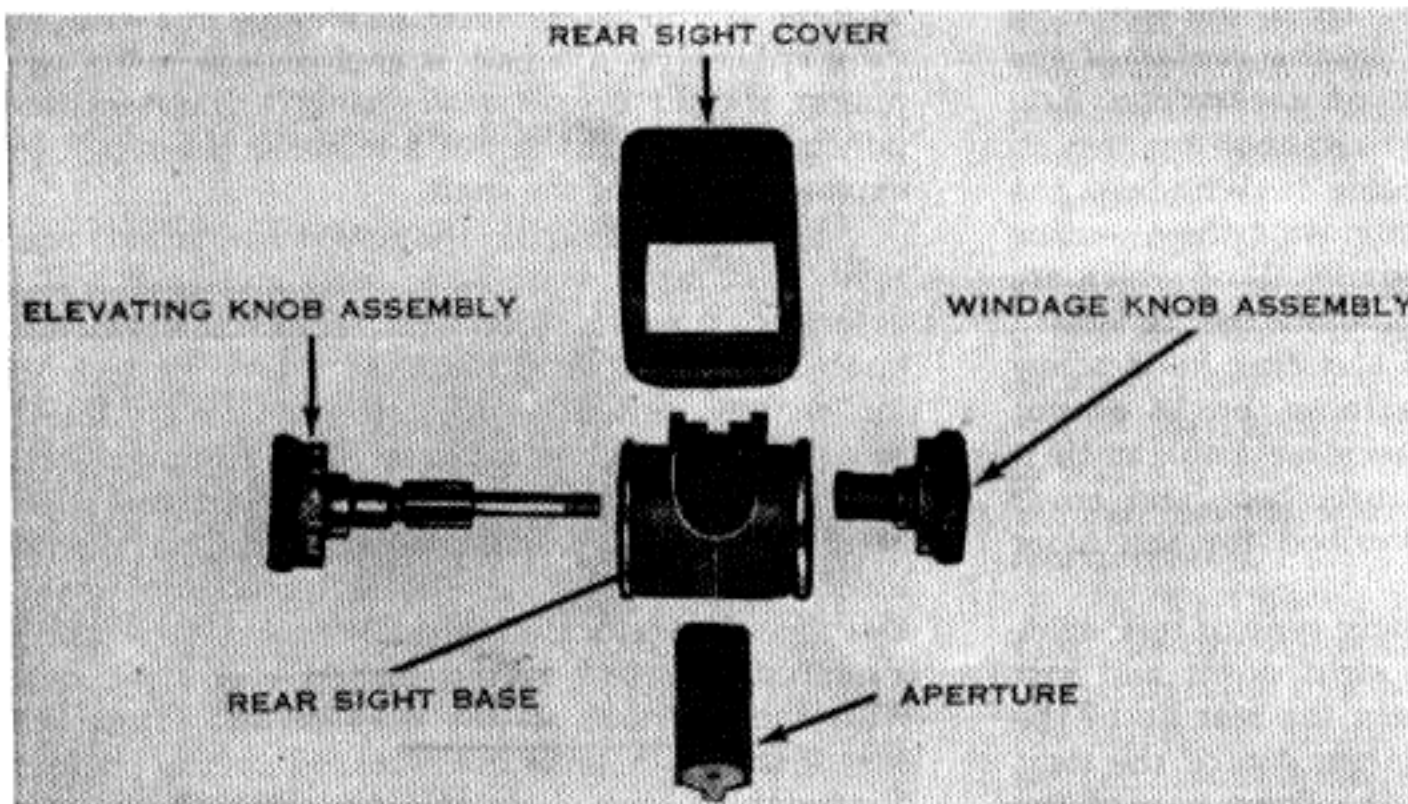
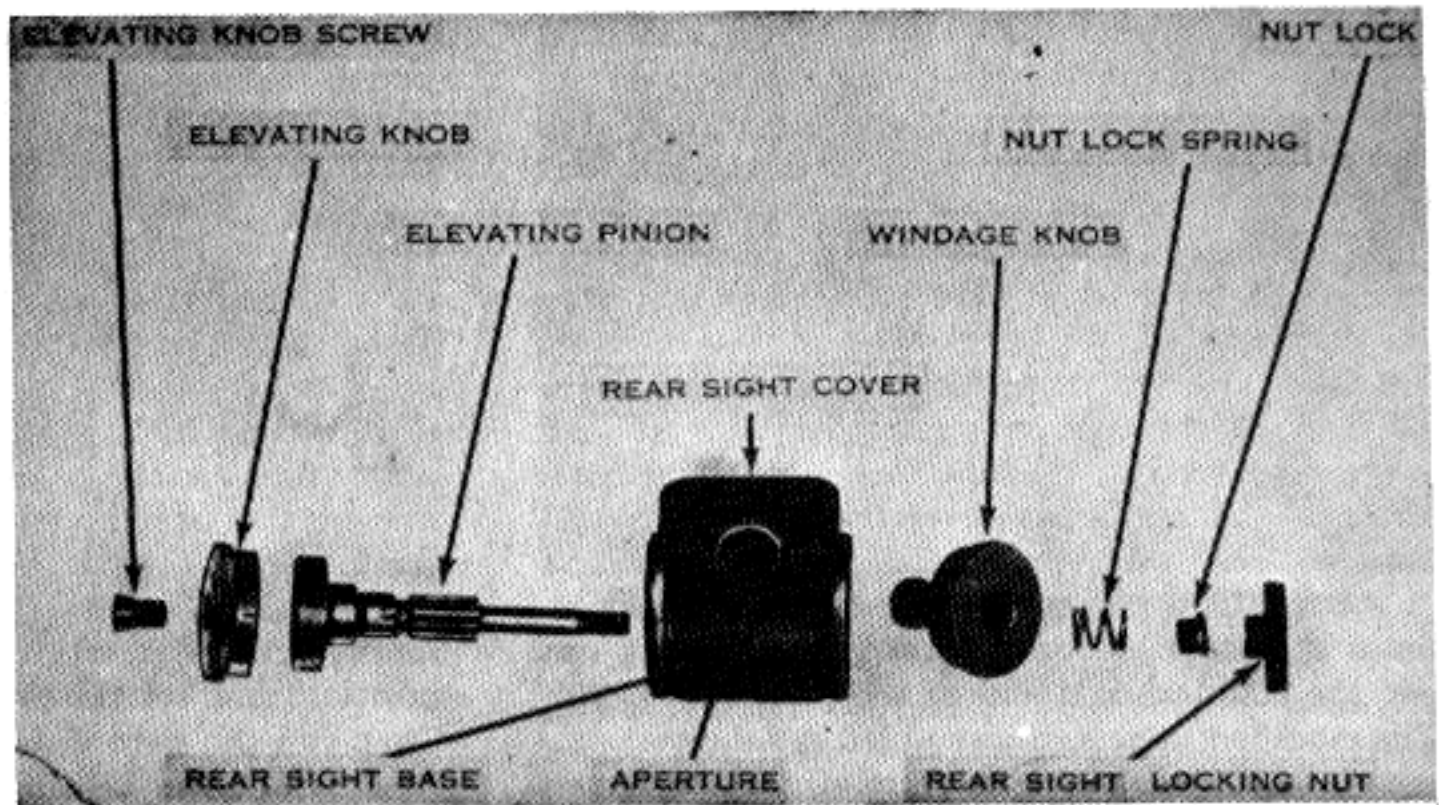

Fig. 70. Parts of new (modified) rear sight.

ing rod handle into the chamber in the same manner used for disassembling the bolt. Push forward on the operating rod handle, compressing the ejector spring, and push the extractor down until it is seated.

(g) The rear sight may be disassembled for parts replacement or cleaning after exposure to extreme elements such as salt water, sand or dust. It should be disassembled only when absolutely necessary (Fig. 69).

(1) To disassemble the rear sight, place the barrel and receiver group on flat surface so the sights are up. Lower the aperture as far as it will go. Check the reading on the rear sight elevating knob and write it down. You will need

this reading when you replace the rear sight elevating knob.

(2) Place the barrel and receiver group on its right side, muzzle to the left. Using the combination tool or screwdriver, remove the rear sight elevating knob screw and the elevating knob. Turn the barrel and receiver group on its left side. The rear sight locking nut can be removed with a pair of pliers. (Note: the elevating pinion has been counter bored on the threaded end to permit spreading after assembly. Frequent disassembly will cause stripping of the threads on the pinion; the rear sight therefor, is disassembled only when necessary as outlined above.) Unscrew and remove the rear sight locking nut. Unscrew

and remove the windage knob, taking care that the rear sight nut lock and spring, which are inside the windage knob, do not become lost. Tap the windage knob lightly to remove the nut lock and spring. Turn the barrel and receiver group so that the sights are up, the muzzle pointing to the front. Pull out the rear sight elevating pinion from the left side of the receiver. Pull the aperture up about one-half inch. Place your thumb under the top of the aperture and push forward and upward to remove the aperture, cover and base. Separate the rear sight cover from the rear sight base.

(3) The newer, modified rear sight eliminates the cross bar on the rear sight locking nut and the counterbored end of the pinion (Fig. 70). The modified sight is disassembled as follows:

(1a) Run the aperture all the way down and record the reading, as you will use this reading when assembling the sight. Hold the elevating knob and unscrew the nut in the center of the windage knob with the rim of a cartridge. You can loosen this nut, but you cannot remove it, so there is no danger of losing it. Withdraw the elevating knob to the left, removing the elevating knob and screw, and other parts, all of which are made into one piece and cannot be separated (like the rear sight nut, the elevating knob screw can be unscrewed until it is loose, but it cannot be removed.) Unscrew the windage knob until it can be removed. The aperture, base and cover are removed as already described for the older sight.

(4) To assemble the early type of rear sight, you first assemble the rear sight cover and rear sight base into one unit. Place the rear lip of the sight cover in its slot at the rear end of the sight bracket. Press down against the front part of the sight cover, seating it in its slot in the front end of the sight bracket. Insert the aperture in its slot in the rear sight base. Slide the aperture to its lowest position. Holding the rear sight base forward against the rear sight cover, insert the elevating pinion through the left side of the receiver, taking care that it meshes with the teeth of the aperture. Insert the windage knob through the right side of the receiver. Move the sight base to the left until the index line shows at the left edge of the windage gauge. Screw the windage knob into the rear sight base until the zero mark on the rear sight base is aligned with the center line of the windage scale on the receiver. Lay the rifle on its left side. Place the rear sight nut lock spring and nut lock in position in the windage

knob around the threaded end of the elevating pinion, taking care that the flat cut on the elevating pinion is aligned with the flat portion of the nut lock. Screw the rear sight nut onto the elevating pinion until the desired tension is obtained on both the elevating knob and the windage knob. When this nut is tightened too much, the elevating and windage knobs become locked and cannot be turned. Lower the aperture as far as it will go by turning the elevating pinion. Replace the elevating knob and rotate it to the reading that was noted before this part was disassembled. Holding it in its position, replace the elevating knob screw. In tightening the elevating screw, run the aperture all the way to its highest position and set the screw as tightly as possible. Then run the sight down and recheck the reading. Be careful when starting the rear sight locking nut on the pinion so that you do not damage the threads. If you can remove the locking nut without using pliers or a small wrench, the end of the pinion should be respread, using a blunt center punch. A very light tap of a hammer is enough to expand the end of the shaft.

5. To assemble the newer (modified) rear sight, first replace the base, cover and aperture as described for the older sight. Screw the windage knob in until it takes hold and draws the base to the center position on the windage gauge. Insert the elevating knob and pinion shaft from the left, meshing the pinion with the teeth on the aperture. The flat portion of the elevating pinion shaft must pass through the D-shaped hole in the lock which is located inside the windage knob assembly adjacent to the slotted rear sight nut. With the aperture all the way down, adjust the elevating pinion until the recorded setting (before disassembly) is on the rear sight. Screw in the rear sight nut with the forked end of a combination tool or the base of a cartridge. Screw it in as far as it will go, then turn it back a fraction of a turn until any change on the rear sight clicks distinctly; the assembly is then completed.

(h) The clip latch (Fig. 71) may be disassembled as follows:

(3) Place the receiver on its right side with the muzzle pointing to the left. With the thumb of your left hand, depress the clip latch, which relieves tension on the clip latch spring. Using the point of a cartridge or a combination tool, push forward on the clip latch pin and unseat it. Remove it by withdrawing it with your fingertips. Lift out the clip latch with the clip latch spring attached.

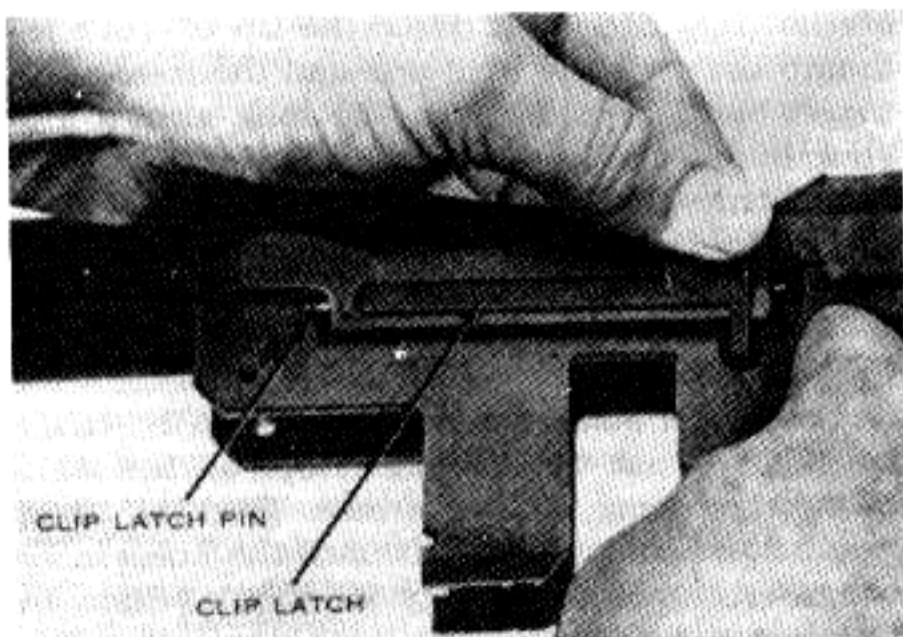

Fig. 71. Disassembling the clip latch.

(2) The clip latch is assembled in reverse order of above.

(i) The trigger group is disassembled as follows (Fig. 72):

(1) Close and latch the trigger guard. Squeeze the trigger, allowing the hammer to go

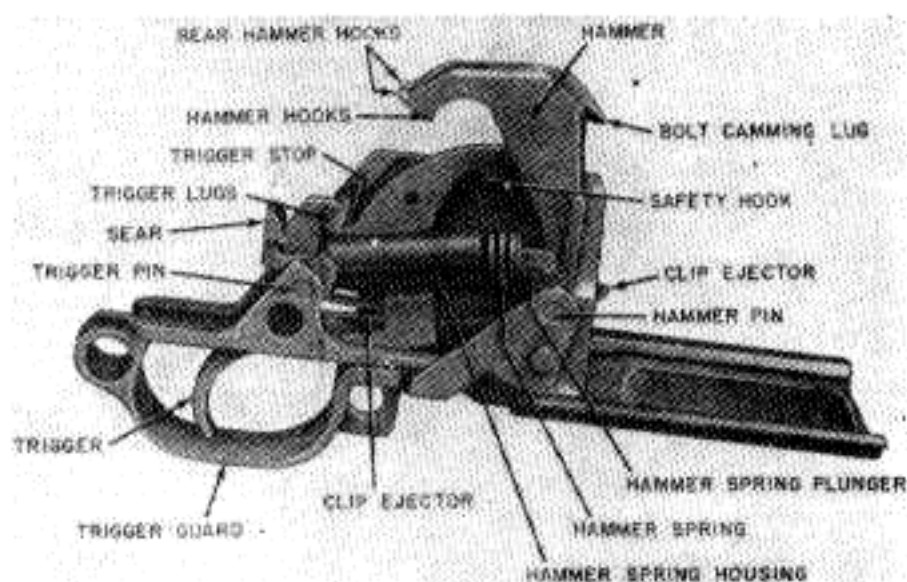

Fig. 72. Trigger housing group.

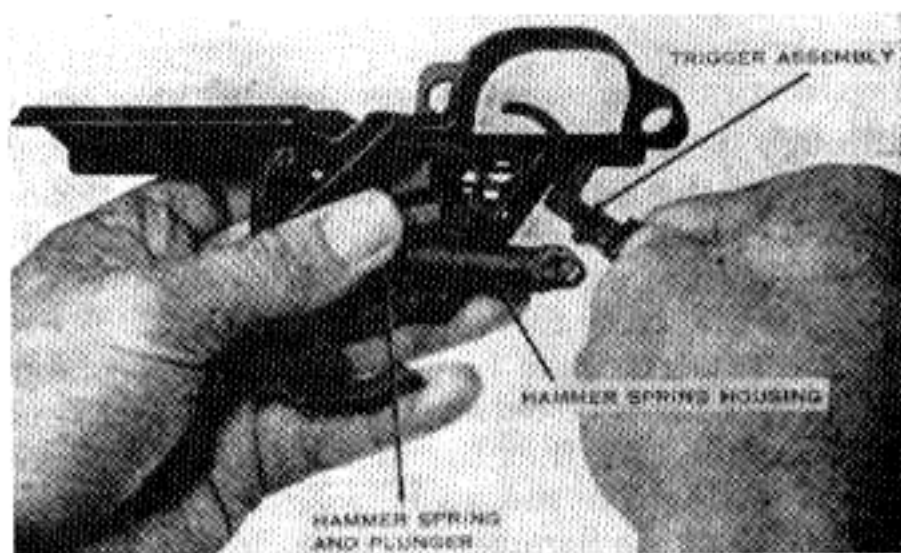

Fig. 73. Removing trigger assembly, hammer spring housing, hammer spring, and hammer spring plunger.

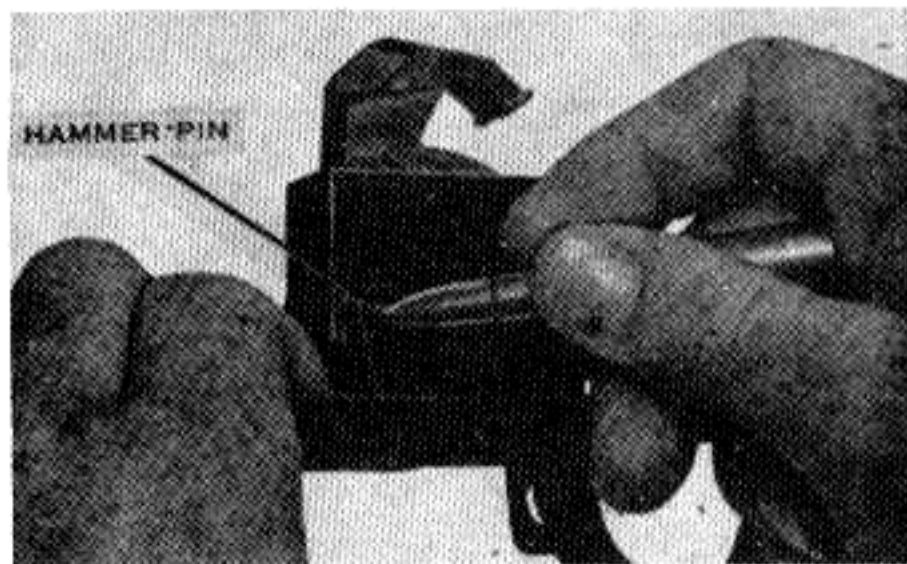

Fig. 74. Removing hammer pin and hammer.

forward under control of your thumb. Hold the trigger group in your left hand with the vertical face to the left and the open face down. Using the tip of a cartridge, apply pressure on the trigger pin until its head is unseated. Slowly push out the trigger pin from left to right, maintaining pressure on the sear with the thumb. Slowly release the pressure, allowing the hammer spring to expand.

(2) Holding the trigger housing group in your left hand as shown in Fig. 73, remove the trigger assembly, hammer spring housing, hammer spring and hammer spring plunger.

(3) Holding the trigger housing as shown in Fig. 74, use the tip of a cartridge to push out the hammer pin. Move the hammer slightly to the rear and lift it out.

(4) Unlatch and open the trigger guard. Push the top of the safety toward the open face to unseat the stud of the safety from its hole. Remove the safety by lifting it from its slot in the base of the trigger housing (Fig. 75).

(5) Holding the trigger guard and trigger group housing as shown in Fig. 76, slide the guard to the rear until its wings are aligned with the

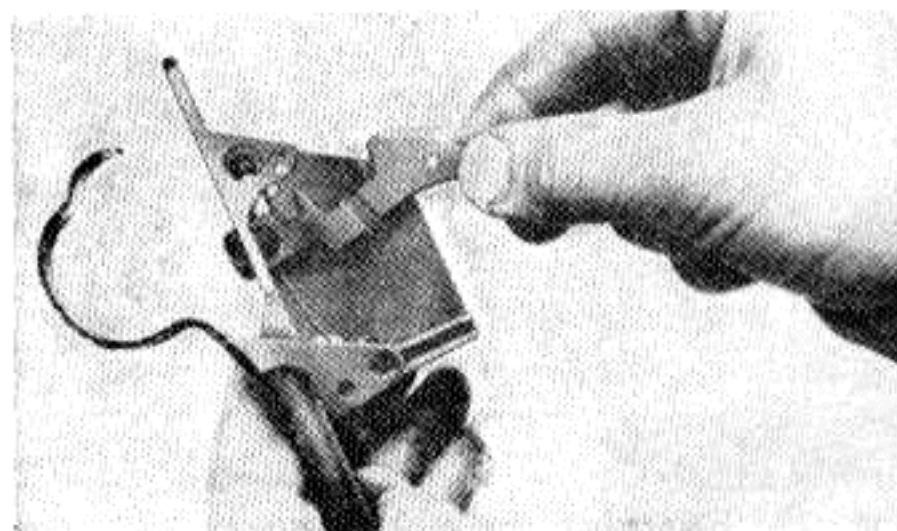

Fig. 75. Removing the safety.

THE FIGHTING GARAND

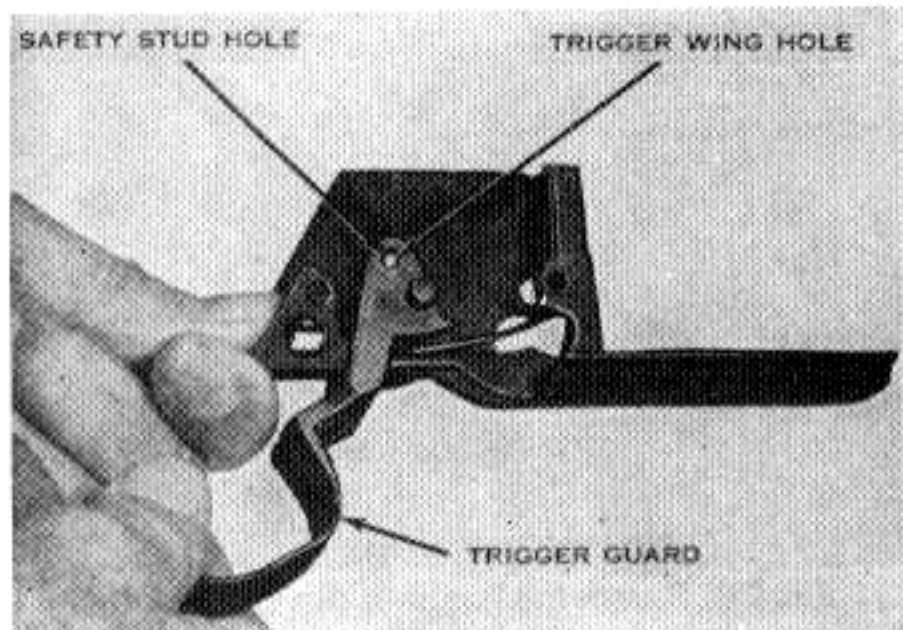

Fig. 76. Removing the trigger guard.

safety stud hole. Rotate the trigger guard upward until the hammer stop inside the right wing clears the base of the trigger housing.

(6) Hold the trigger housing in your left hand as shown in Fig. 77, resting on a solid surface. Using the tip of a cartridge, apply pressure on the clip ejector through its dismount hole and unseat it from its stud.

(j) The trigger housing group is assembled in reverse order of disassembly, as follows:

(1) Hold the trigger housing in your right hand, with the left side down and the rear end to the right. Place the clip ejector in position in the trigger housing with the short arm toward your body and the tip of the long arm in its slot in the front of the trigger housing. The loop of the clip ejector is positioned on the top of its stud on the left side of the trigger housing. With your right thumb, hold the loop of the clip ejector on top of this stud. With the forefinger of your left hand, hold the long arm up in its slot on the front

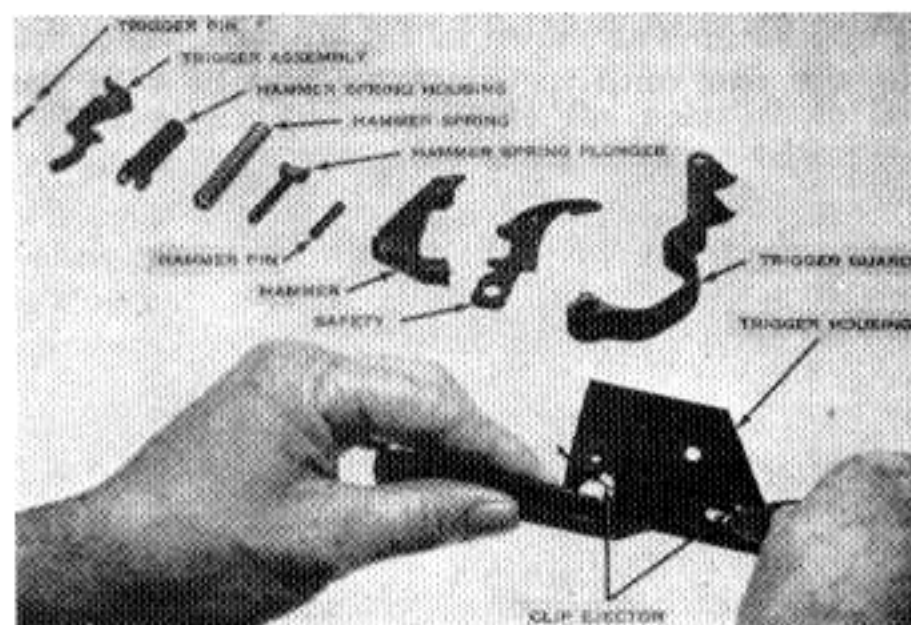

Fig. 77. Removing the clip ejector, other parts shown in order of disassembly.

of the trigger housing. Place the tip of your left thumb between the long arm and the base of the trigger housing and move the long arm toward your body, at the same time exerting a pressure downward. The long arm of the clip ejector will snap into the notch on the base of the trigger housing (Fig. 78).

(2) To replace the trigger guard, hold the trigger housing as shown in Fig. 76. Place the wings of the trigger guard astride the base of the trigger housing so that the hammer stop, on the inside of the right wing, clears the base. Turn the trigger guard down and to the left until the holes in the wings are under the safety stud hole. Slide the trigger guard forward until the holes in the wings are aligned with the hammer pin hole.



Fig. 78. Replacing the clip ejector.

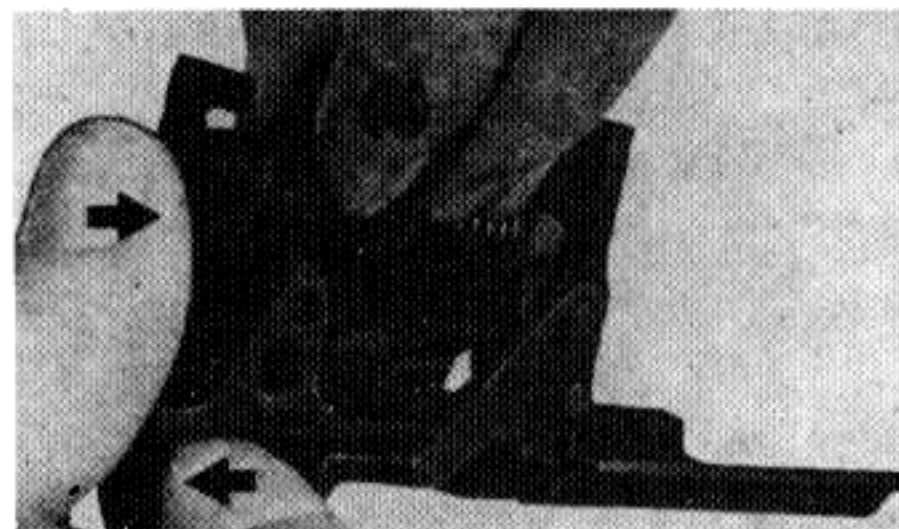

Fig. 79. Replacing the trigger assembly, hammer spring housing, hammer spring and plunger.

(3) Insert the finger piece of the safety through its slot in the base of the trigger housing. To reseat the safety stud in its hole in the trigger housing, force the safety down against the pressure of the short arm of the clip ejector. Push the finger piece of the safety forward.

(4) Insert the hammer loosely in position, holding it halfway between the cocked and fired position. Be sure that the hammer toe clears the hammer stop on the right wing of the trigger guard. Align the hammer pin holes in the hammer with the holes in the trigger housing and trigger guard. Be sure that the trigger guard is not latched. Insert the hammer pin from the right side. Move

the hammer to the fired position. Close and latch the trigger guard.

(5) Place the trigger housing group on the table with the base down and the rear end to the right. Assemble the hammer spring housing, hammer spring, and hammer spring plunger into one unit. Place the plunger in its seat on the hammer. Make sure the open side of the hammer spring housing is toward the safety. (This is important because failure to do so prevents the safety from being used, also the sear will not function.) Hold these assembled parts in a raised position with the thumb and fingers of your left hand. With your right hand, insert the trigger into the trigger slot so that the notch at the curved rear surface of the finger piece bears against the rear slot in the trigger housing. Place the wings of the hammer spring housing astride the sear pin. With your right forefinger on the trigger and the right thumb against the sear, apply pressure forward against the sear and at the same time squeeze the trigger. Hold the parts in this position and insert the trigger pin as far as its head only (Fig. 79).

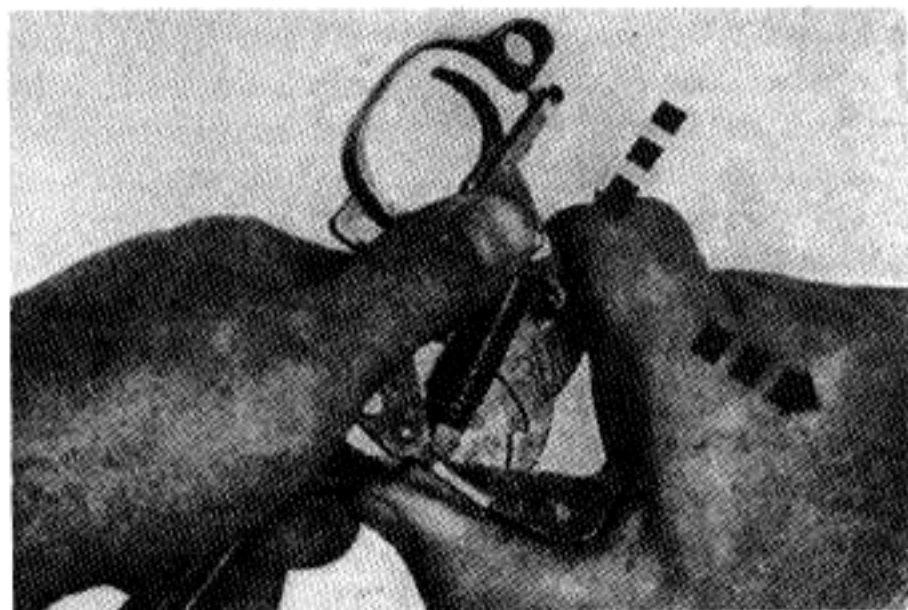

Fig. 80. Seating the trigger pin.

(6) To seat the trigger pin, hold the trigger housing group as shown in Fig. 80. Note the direction the pin must be moved to be seated. By applying pressure with the thumb and fingers, align the head of the trigger pin with the trigger pin holes. Seat the trigger pin by pressing on its head with the left thumb.

(k) To remove the gas cylinder, unscrew the gas cylinder lock screw with a counter-clockwise motion as shown in Fig. 81. Use a wide bladed screwdriver, combination tool, or the screwdriver end of the M10 cleaning rod handle. Next, unscrew the gas cylinder lock, as shown in Fig. 82. Withdraw the gas cylinder straight to the front. If the

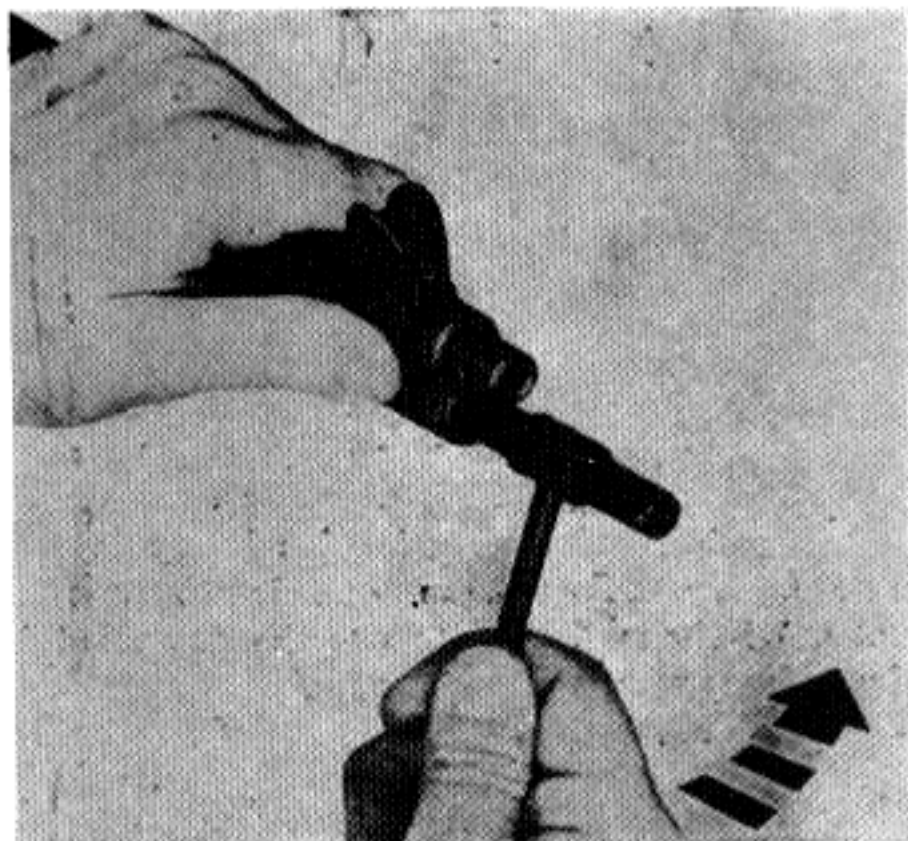

Fig. 81. Removing the gas cylinder lock screw.

gas cylinder does not readily slide forward (as when heavily fouled with carbon), rap smartly on the back of the bayonet lug, using a stick of wood or other soft instrument. Do not beat on the back of the front sight. NOTE: on rifles with gas cylinders that have been modified by a cut that extends from the front sight base dovetail downward to the lower splines, it is necessary to loosen the front sight screw before attempting to remove the gas cylinder. Otherwise, the barrel and gas

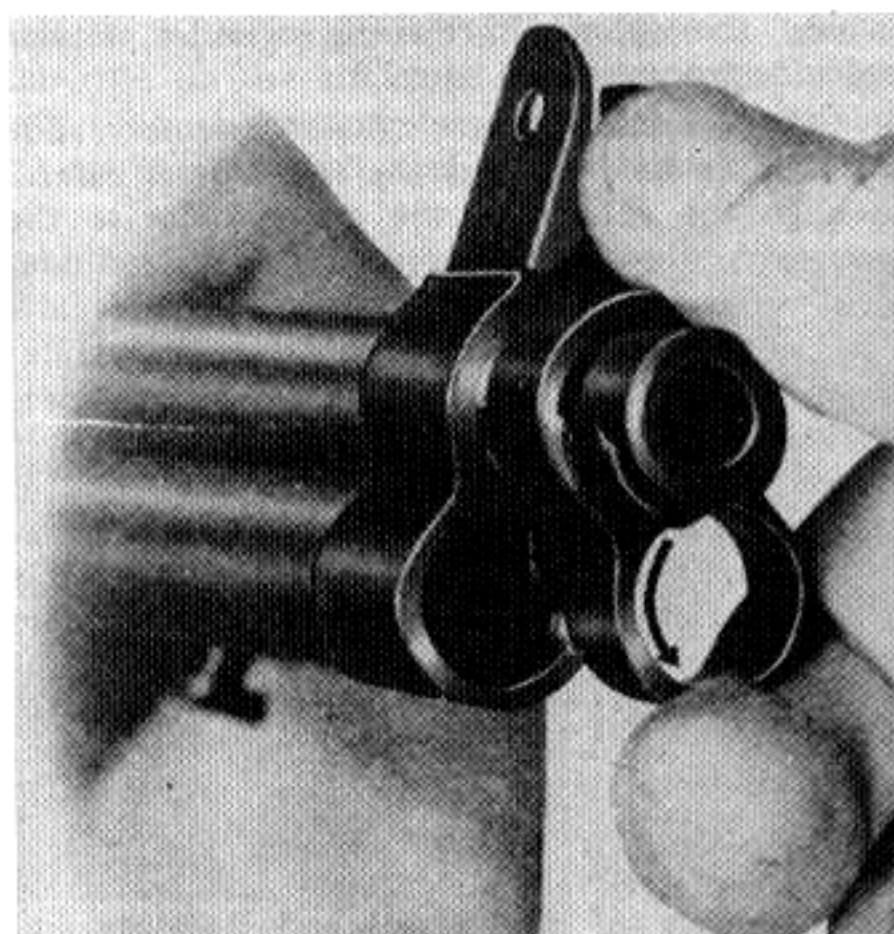

Fig. 82. Removing the gas cylinder lock.

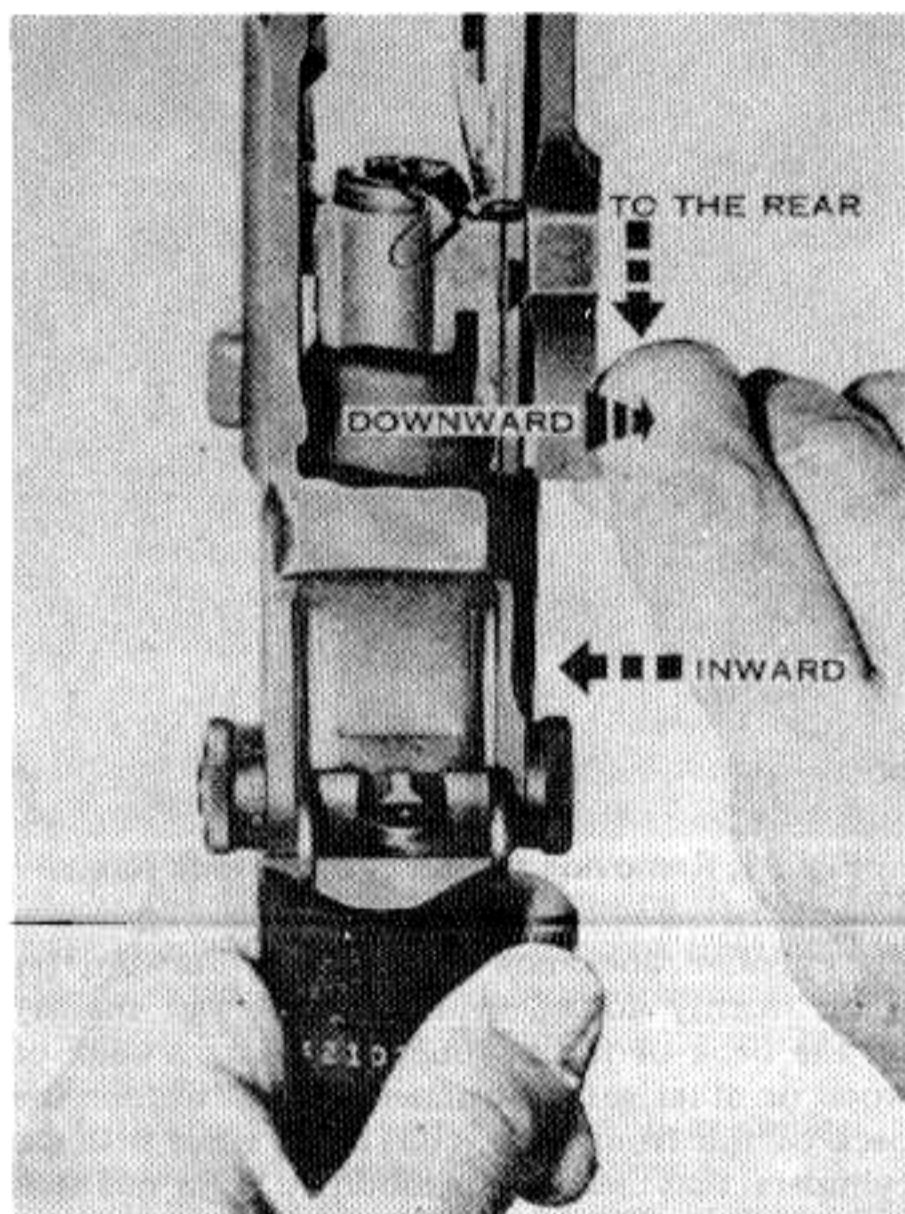

Fig. 83. Replacing the operating rod.

cylinder may be damaged. Care must be exercised when removing any gas cylinder, in order not to damage the splines in the gas cylinder or the matching grooves in the barrel.

(l) To replace the gas cylinder assembly, slide the gas cylinder back over the barrel, being careful to align the splines of the gas cylinder to the grooves in the barrel. Replace the gas cylinder lock, turning it clockwise. If the gas cylinder lock does not align perfectly with the gas cylinder when screwed up snugly, do not attempt to force it! Rather, unthread the gas cylinder lock in a counter clockwise direction until the lock is aligned with the cylinder. Then, screw in the gas cylinder lock screw. The gas cylinder lock screw must be screwed on tightly and kept tight, because if it is loose it will cause a vibration at the end of the barrel when the rifle is fired, which may affect the accuracy of the rifle. If the sight screw was loosened to remove the gas cylinder, tighten it snugly.

25. Assembly of the Barrel and Receiver and Trigger Housing Groups:

(a) If the front handguard has been removed, replace it, insuring that it is seated in the front band.

(b) Replace the gas cylinder, as outlined in Para. 24 (l).

(c) To replace the bolt, hold it by the operating lug and place the rear end of the bolt onto the bridge of the receiver. Rotate the bolt counter-clockwise as far as necessary to permit the tang of the firing pin to clear the top of the bridge of the receiver. Guide the left locking lug of the bolt into its groove on the left side of the receiver. Lower the right locking lug on its bearing surface and slide the bolt halfway to the rear.

(d) To replace the operating rod, hold the handle with the right hand and place the piston end into the gas cylinder. Align the operating rod so that the recess in the hump fits over the operating lug on the bolt. While applying pressure downward and inward on the handle, pull the operating rod to the rear until the guide lug is engaged in its groove (Fig. 83). Move the operating rod forward until the bolt is closed.

(e) Turn the barrel and receiver group over so that the sights are down and the muzzle is to the left. Replace the follower assembly so that its guide ribs fit into their grooves in the receiver. Make sure that the slide of the follower is down and that the square hole is to the rear. The slide will rest against the bolt.

(f) Replace the bullet guide so that its shoulders fit into their slots in the receiver and the hole in the toe of the bullet guide is aligned with the holes in the receiver (Fig. 84).

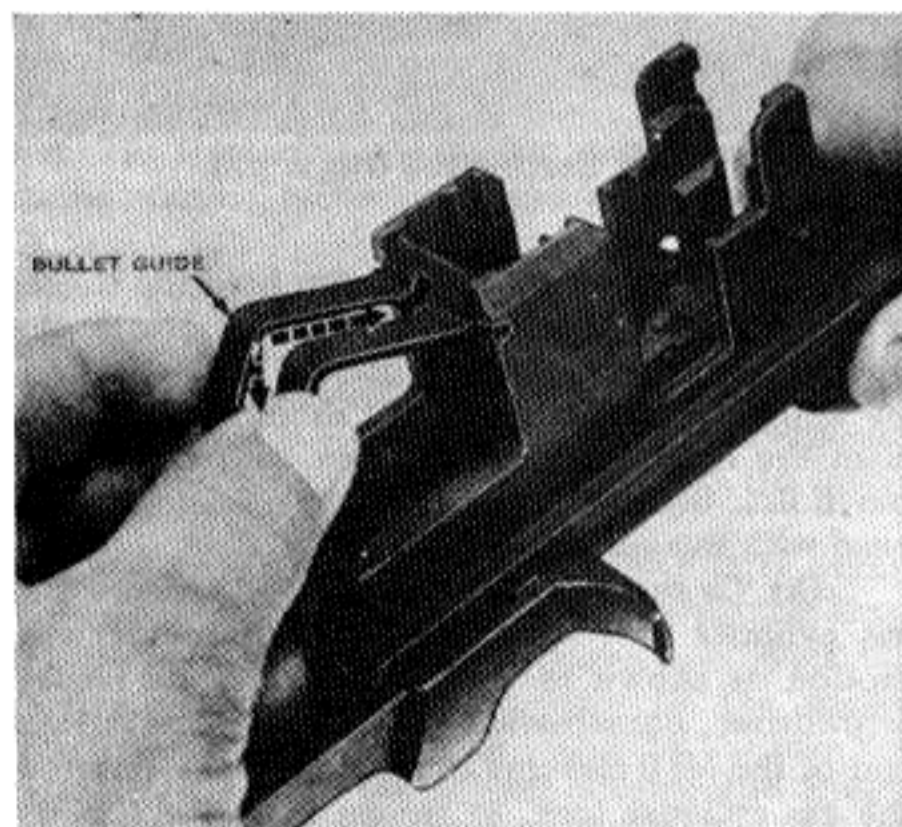

Fig. 84. Replacing the bullet guide.

THE FIGHTING GARAND

(g) With the right hand, lift the lower part of the bullet guide slightly. With the left hand, insert the rear arm of the operating rod catch assembly through the clearance cut in the side of the bullet guide. Make sure the rear arm is underneath the front stud of the clip latch which projects into the receiver. Lower the bullet guide into place. Test for correct assembly by pressing down on the front arms of the operating rod catch assembly. It should move, and you should be able to feel the tension of the clip latch spring (Fig. 85).

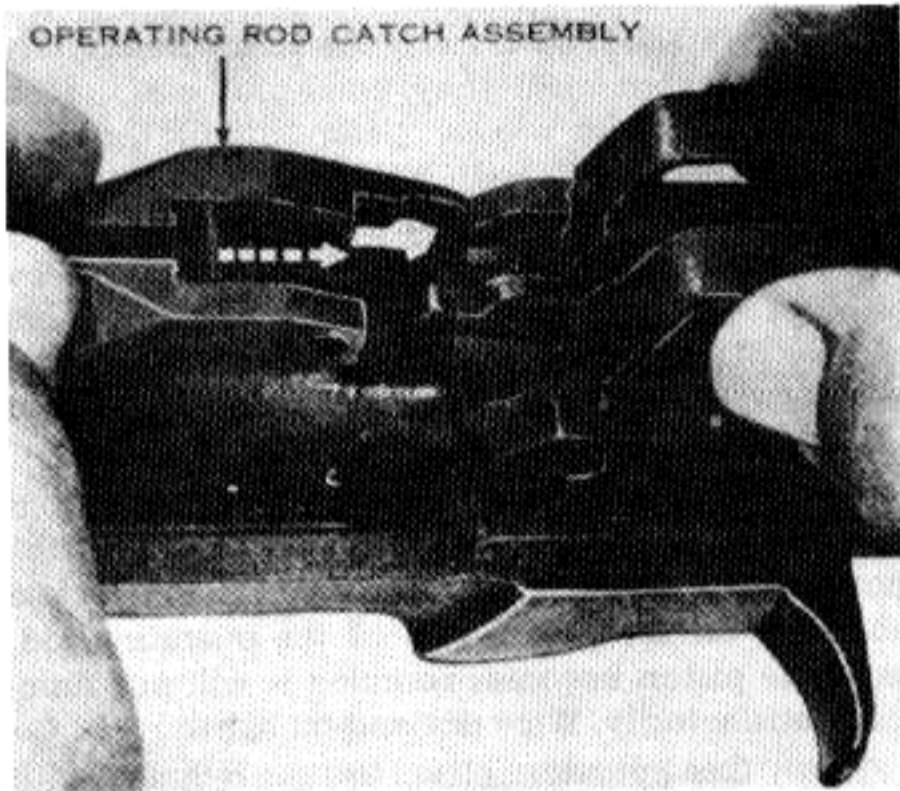

Fig. 85. Replacing the operating rod catch assembly.

(h) Replace the follower arm by passing its rear studs through the bullet guide and inserting them into the guide grooves on the follower (Fig. 86). Allow the wings of the follower arm to rest astride the toe of the bullet guide. Align the holes in the operating rod catch assembly, follower arm, and bullet guide with those in the receiver and replace the follower arm pin from the near side.

(i) Insert the loose end of the operating rod spring into the operating rod. Grasp the follower rod with the left hand, making sure that its hump is toward the barrel. Pull towards the muzzle, compressing the operating rod spring, and engage the claws of the follower rod with the front studs of the follower arm (Fig. 87). It is easier to do this if you raise the follower arm slightly.

26. To assemble the three main groups of the Garand rifles:

(a) Place the barrel and receiver group on a flat surface, sights down (making sure the aper-

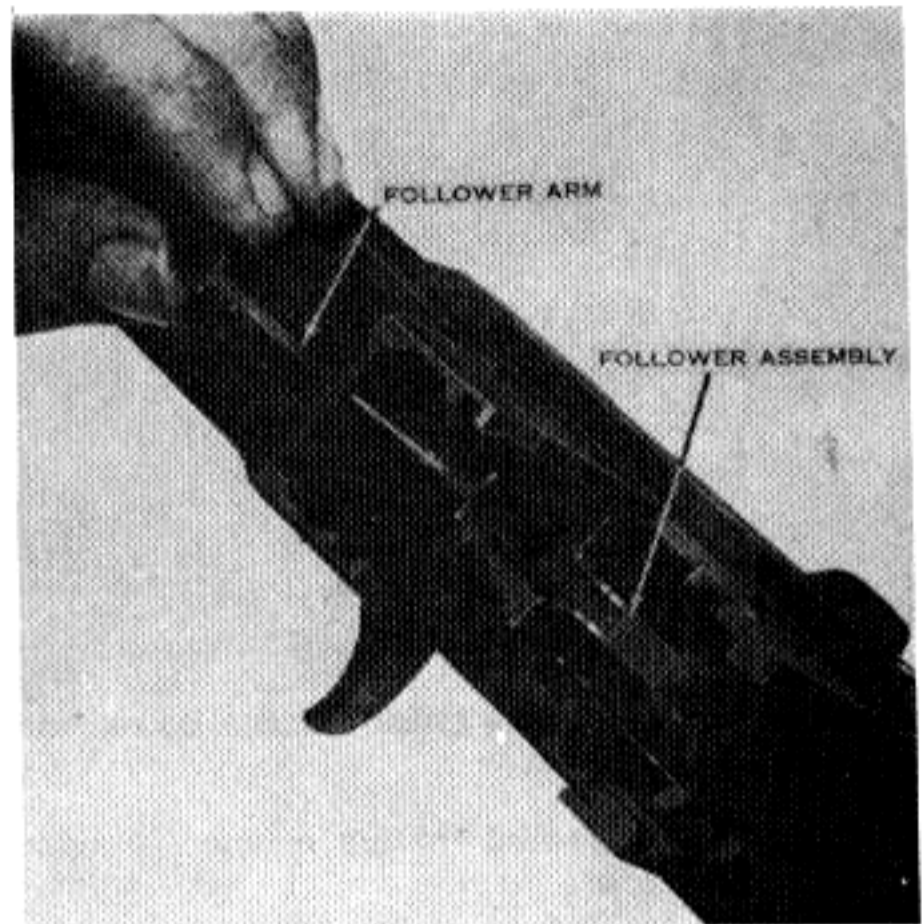

Fig. 86. Replacing the follower arm.

ture is at its lowest position, to avoid damage to same). Pick up the stock group and engage the U-shaped flange of the stock ferrule in the lower band (Fig. 88).

(b) Unlatch and open the trigger guard (this is easier if the hammer is cocked). Keeping the base of the trigger housing group level, place it straight down into the receiver, making sure that the locking lugs on the trigger guard enter their recesses in the receiver (Fig. 89). Place the butt of the rifle on the left thigh with the sights to the left. Close the trigger guard and latch it by striking it smartly with the heel of the right hand. The

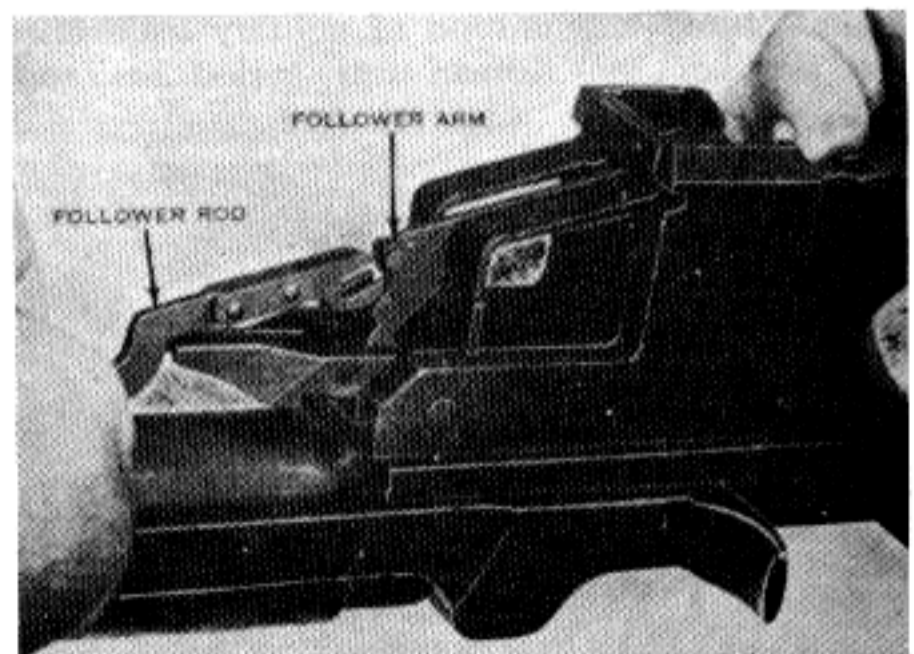

Fig. 87. Replacing the follower rod and operating rod spring.

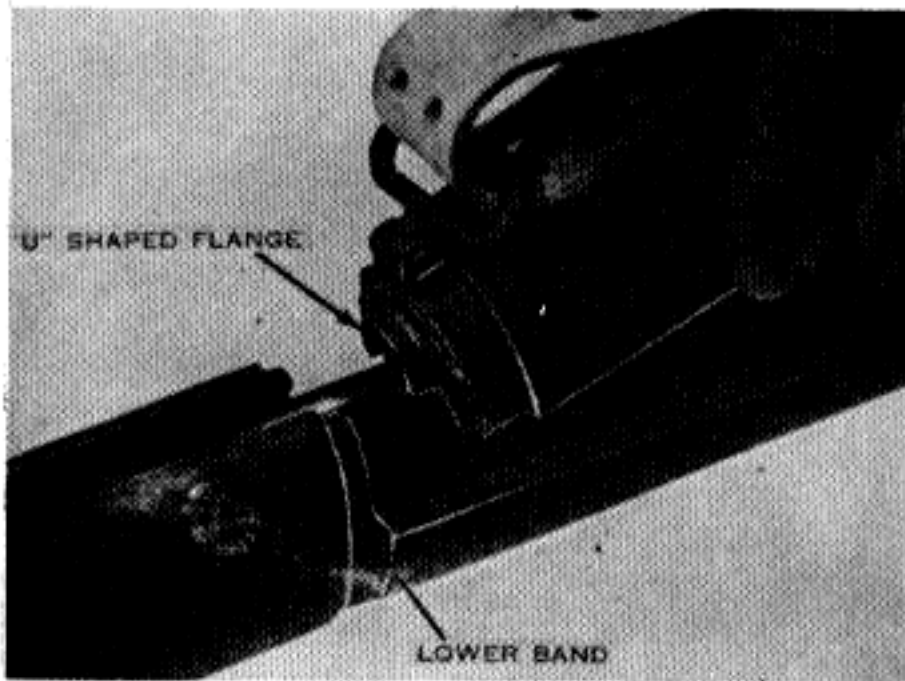

Fig. 88. Replacing the stock on the barrel and receiver group.

trigger guard is latched in this manner to avoid damage to the rear sight.

27. Test for correct assembly: each time the rifle is disassembled and assembled it should be tested to make sure it is put together properly. To do this, pull the operating rod to its rearmost position. The bolt should stay open. Close the bolt and snap the safety to its locked position. The hammer should not fall. Push the safety to its unlocked position and squeeze the trigger. The hammer should fall. This test is made to check the operation of the safety.

Section 2, Cleaning

28. The rifle must be cleaned after it has been fired because firing produces primer fouling, powder ashes, carbon and metal fouling. American manufactured ammunition of military issue since the start of the Korean war period has non-

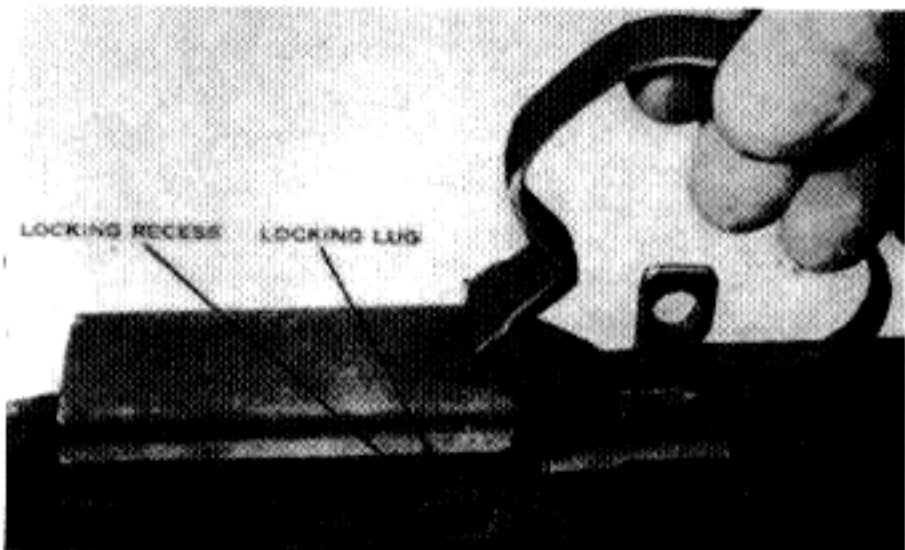

Fig. 89. Replacing the trigger housing group.

corrosive primers which make cleaning much easier, but no less important. These primers still leave a deposit that may collect moisture and promote rust if not removed. Many excellent commercial and G.I. issue bore cleaners are available, hot soapy water may serve as an expedient.

(a) Chamber: the chamber should be thoroughly scrubbed with bore cleaner and a chamber brush (issue chamber brush shown in Fig. 90), and wiped clean.

(b) Bore: saturate a bore brush with bore cleaner and scrub thoroughly. Saturate a patch with bore cleaner and swab the bore thoroughly. Change patches until they come out clean, then dry the bore with a clean patch and oil the bore and chamber lightly with a good grade of gun oil, or as an expedient No. 10 motor oil.

(c) Gas cylinder lock screw with lock assembly: remove carbon deposits by using bore cleaner. Do not use abrasives. Check to see that the valve is not held open by particles of dirt or sand. Wipe dry and oil lightly.

(d) Operating rod: remove any carbon from the piston end with bore cleaner. Clean the tube portion with a patch and bore cleaner. Do not use abrasives on the piston end of the operating rod, as if the piston becomes rounded it will not function satisfactorily. Wipe dry and oil lightly.

(e) Gas cylinder: clean the gas cylinder with bore cleaner and patches. Use caution when removing carbon deposits from the front end of the gas cylinder, so as not to damage the inside of the cylinder or the splines which fit on the barrel. Wipe dry and oil lightly.

(f) Face of bolt: clean with bore cleaner and a patch, or scrub with a long bristled, soft brush. If corrosive ammunition has been fired, disassemble the bolt and clean the inside with bore cleaner to prevent rust. Wipe clean and oil lightly.

(g) Other parts: use dry cloth to remove dirt or sand from other parts and exterior surfaces. Apply a light coat of oil to all metal parts, and rub a light coat of raw linseed oil onto wooden parts. Be careful not to get linseed oil on metal parts, as it will dry and leave a gum which will hamper functioning.

(h) The rifle should be cleaned the same day it is fired, and the bore should be wiped dry and re-oiled for three consecutive days after firing, to check for possible rust. A light coat of oil should be kept on all metal parts.

Section 3, Routine Maintenance

THE FIGHTING GARAND

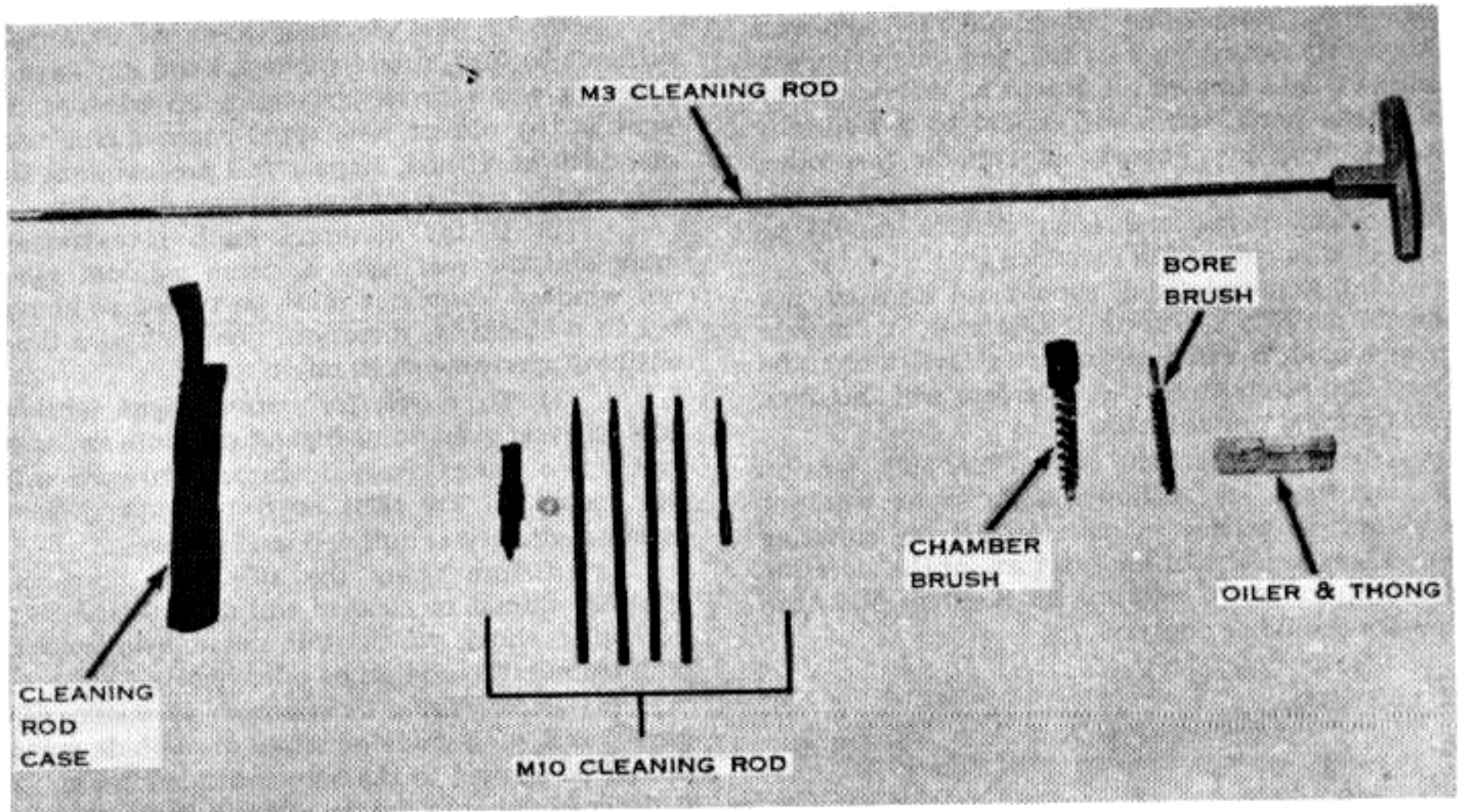

Fig. 90. Issue cleaning accessories.

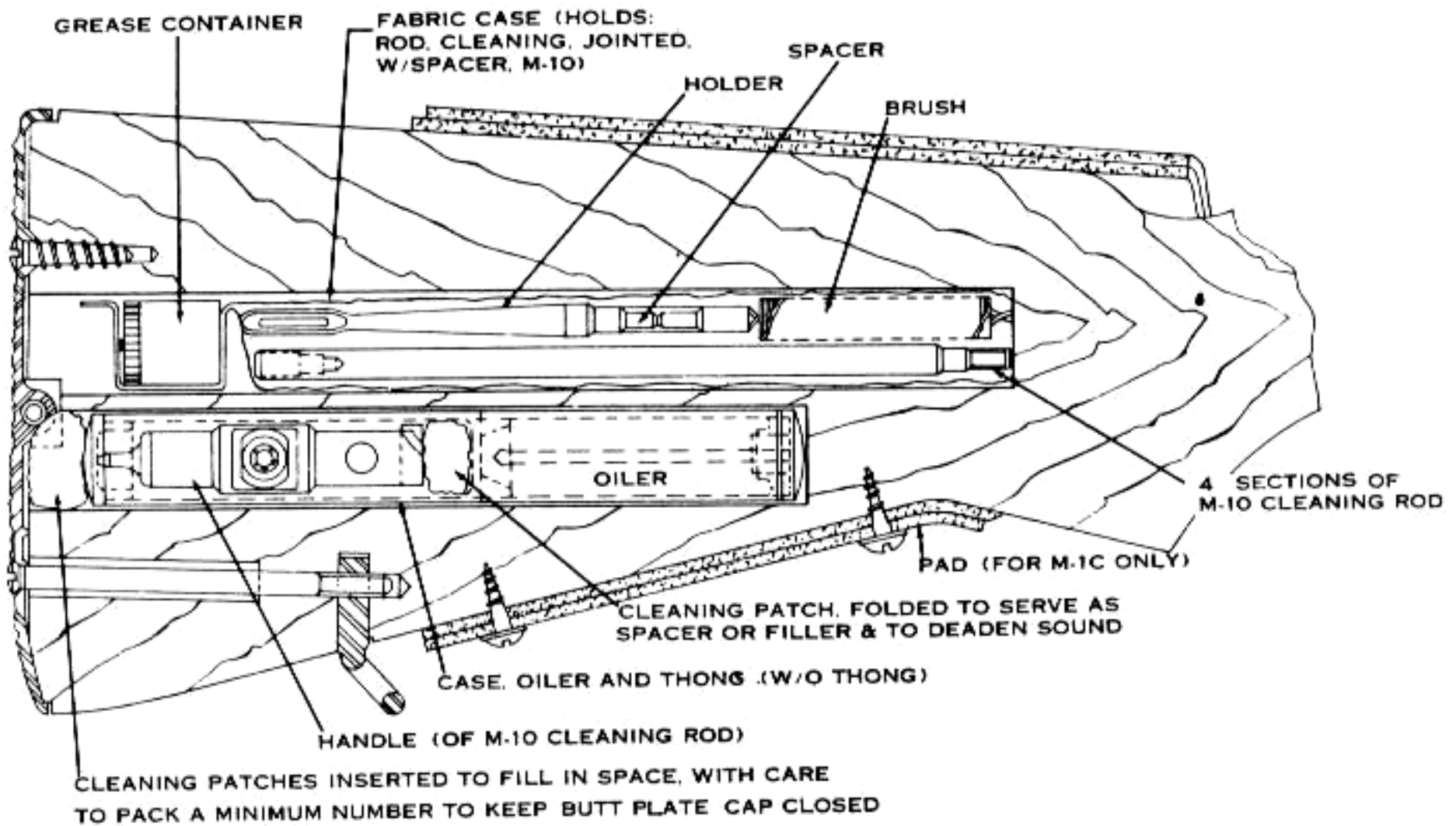

Fig. 91. Stowage of cleaning accessories in rifle butt trap.

THE FIGHTING GARAND

29. When in use, the rifle should be inspected frequently for evidence of rust and general appearance. A light film of oil should be maintained on all metal parts, and wood should be periodically rubbed with raw linseed oil. Periodic inspection should reveal any defects such as burred, worn, or cracked parts, and such defects should be corrected as outlined in Part Two.

(a) A muzzle plug should not be used, nor should the rifle be kept in a rifle case. If a muzzle plug is used, it will tend to collect moisture in the bore, and promote rust. A rifle case will also draw moisture and promote rust.

(b) Maintaining the correct rear sight tension is important, as without it the sight will not maintain its setting in elevation. If the elevating knob is extremely difficult to turn, or the elevating knob turns freely without an audible click, the tension should be adjusted.

(1) If the elevating knob is extremely difficult to turn, rotate windage knob nut (with a pliers or screw driver depending on whether the sight is the old or new type) counter clockwise one click at a time. Repeat this process until the knob can be turned without extreme difficulty.

(2) If the elevating knob is extremely loose and the rear sight aperture will not raise, the windage knob nut must be turned as above, but in a clockwise direction, one click at a time, until the aperture can be raised.

(3) To check for correct sight tension, raise the rear sight to its highest position, and then lower two clicks. Push down and forward with the thumb. If the sight aperture drops, tension must be adjusted as outlined in (2) above.

(c) Before firing the rifle, the bore and chamber should be cleaned and dried. Metal parts excepting those which will come into contact with ammunition should be oiled lightly.

(d) Before firing or exposure to water, rifle grease or a good grade of molly di-sulphide grease should be applied to the parts indicated in Fig. 92. Rifle grease should not be applied if the weapon is to be exposed to extremely cold temperature or extremes of sand and dust.

(e) In cold climates, the rifle should be kept free of moisture or excess oil, which will cause operating parts to operate sluggishly or fail completely.

(f) In hot, humid climates or if exposed to salt water, the rifle must be inspected thoroughly during frequent intervals for signs of moisture or rust. Metal parts should be kept well oiled and wood should be treated with raw linseed oil to prevent swelling.

(g) In hot, dry climates the rifle should be cleaned frequently to remove sand and/or dust from the bore and working parts. In sandy areas, the rifle should be kept dry. The rifle should be lightly oiled when sandy or dusty conditions decrease.

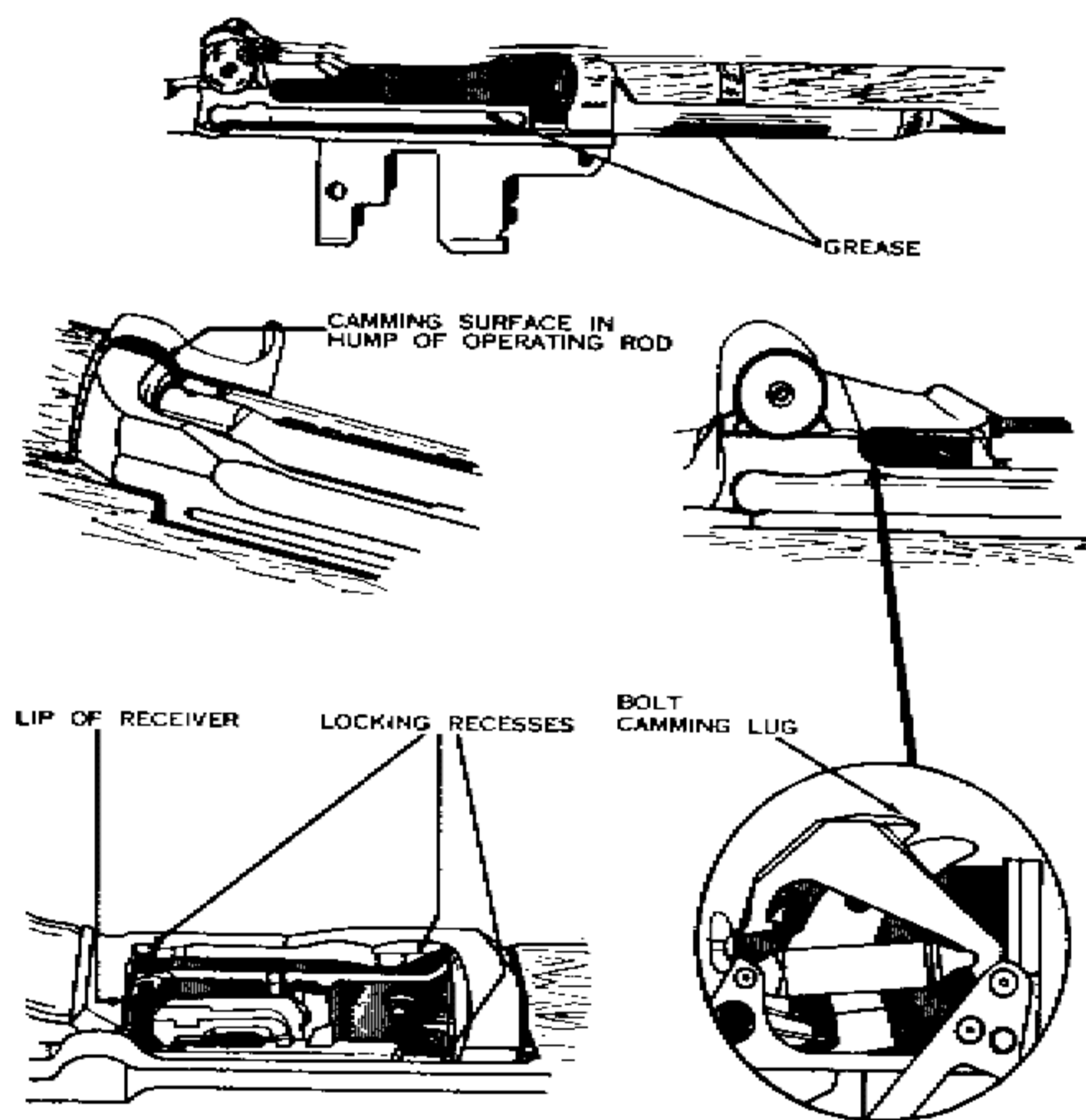

Fig. 92. Points to apply rifle grease.



V. Inspection

Section 1, Inspection Prior to Disassembly

30. Fundamentally, inspection is for the purpose of determining whether the rifles are serviceable and dependable. When a rifle is found to be unserviceable, the cause and extent of the unserviceability should be determined and corrected.

(a) Before any rifle is inspected, it should be cleared and the chamber and bore checked for obstructions.

(b) Before inspection, the rifle should be thoroughly cleaned to remove any grease, dirt, or other foreign matter which might interfere with its proper functioning or the use of the gages and tools used in inspection.

(c) Inspection, maintenance and repair of the rifle should be thorough and exacting, for the malfunction of one small part may cause malfunction of the rifle.

31. The rifle should be visually inspected for general condition, operation, and functioning before disassembly for detailed inspection. During such inspection, dummy cartridges should be used.

(a) The bolt: place a clip of eight dummy cartridges in the receiver of the rifle in the normal manner, and allow the bolt to close. Check the operating rod handle to make certain that the bolt is in the fully closed position. Then slowly retract the bolt to note whether the extractor has fully engaged the cartridge and whether the ejector throws the cartridge from the receiver. Retract the bolt fully and repeat the operation until the entire clip of eight cartridges has been fed through the successive cycle of operations. As the last cartridge is ejected, the empty clip should also be thrown firmly upward and away from the receiver.

The operating rod handle and bolt should then remain in the retracted position.

(b) Trigger pull: the trigger, when pulled, should move to the rear without stopping or gritting. Trigger pull must be greater than 5 1/2 pounds but should not exceed 7 1/2 pounds for the M1 rifle, and is not to be less than 4 1/2 pounds or more than 6 1/2 pounds for the M1C and M1D rifles. Trigger pull is determined by using trigger pull weights (Fig. 93). With the rifle cocked and the safety in the forward position, rest the weight on the floor or ground and hook the trigger weight wire onto the trigger so that pressure is applied about 1/4 inch from the lower end of the trigger. Make certain the rod contacts only the trigger and does not rub against the trigger guard or stock, and that the rod and barrel are both vertical and parallel; then carefully raise the weight from the floor. In testing the rifles, if the minimum weight trips the hammer or the maximum weight fails to trip the hammer, correct the trigger pull as outlined later on.

(c) Clip ejector: inspect function and spring tension of clip ejector with loaded clip in rifle.

(d) Rear sight: try the rear sight elevation and windage knobs for operation (Fig. 94). To verify the setting of the rear sight, set the 100-yard elevating knob graduation opposite the index line on the receiver. With this setting it should be possible to depress the aperture from one to nine clicks. Check the cover for tightness and tension relative to the aperture.

(e) Gas cylinder group: check the parts of the gas cylinder group for dents, burs, etc. Check the front sight for looseness, bent or burred wings, and check the blade for "shine".

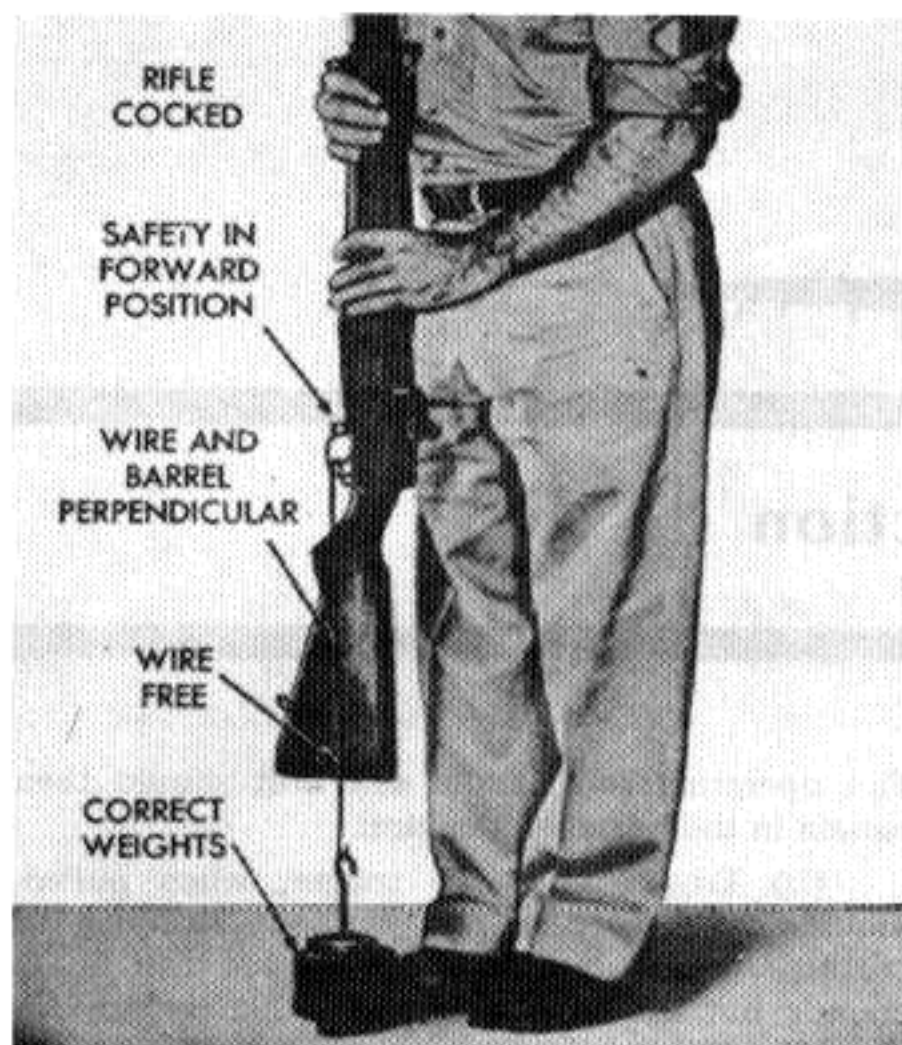

Fig. 93. Testing trigger pull.

(f) Clip latch: check the clip latch for freedom of movement and tension of the spring.

(g) Barrel and receiver group: the barrel is inspected visually to determine the condition of the bore and the extent of deterioration that has taken place. A gage inspection is made to determine the amount of wear that has taken place at the origin of the rifling with a breech bore gage (Fig. 95). The wear in the chamber or in related parts affecting headspace is checked with headspace gages as specified in the serviceability chart (Fig. 96). Military rifles are classified according to varying degrees of serviceability, depending upon the use to which the rifle is to be put. This is included herewith as it makes a handy reference

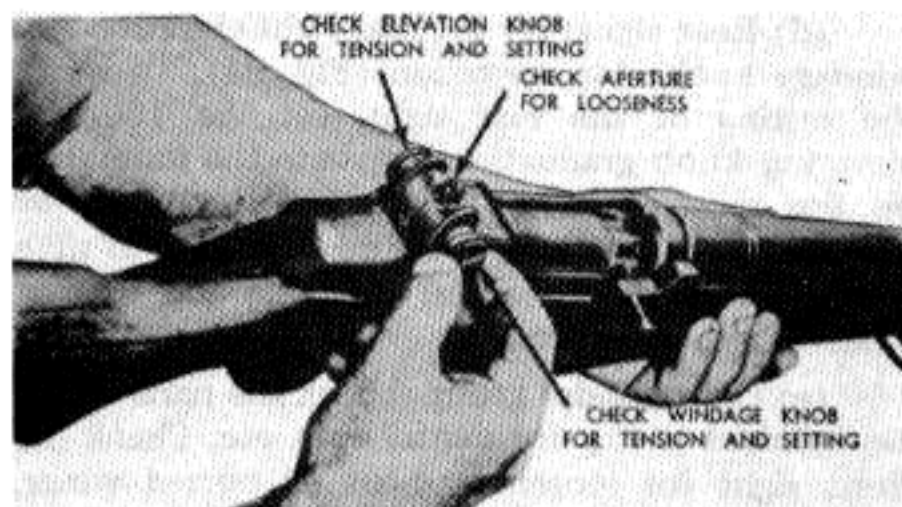

Fig. 94. Checking rear sight (old type).

for determining whether the rifle in question is serviceable for the use in mind, i.e., plinking, hunting, serious target shooting, etc.

(h) Gage inspection offers no problems, as the tolerances are definitely set; however, classification of barrels by visual inspection varies with the disposition to be made of the rifle, and such classification is largely a matter of individual skill and judgment.

(1) The serviceability chart (Fig. 96) shows the limits for breech bore and headspace requirements. For classification of the barrel by visual inspection to be fit for use by using military organizations, the following standards have been set. If the barrel is pitted to the extent that the sharpness of the lands is affected, or if it has a pit or pits in the lands or grooves large enough to permit the passage of gas past the bullet, it is to be scrapped. A pit, the width of a land or groove and $\frac{3}{8}$ inch long or longer, indicates this condition. Examine the barrel for mechanical damage and examine the chamber for deep pits that would seriously affect extraction.

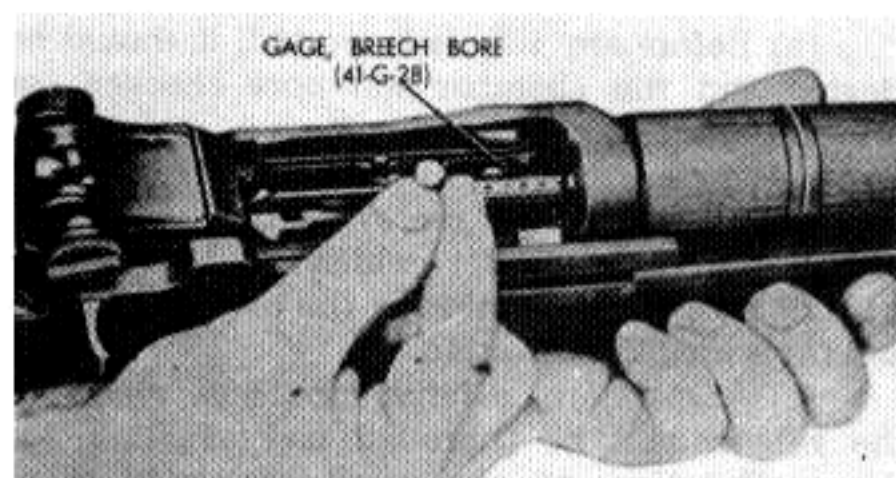

Fig. 95. Checking with breech bore gage.

(2) On weapons to accompany troops overseas, check the headspace as per the serviceability chart (Fig. 96). Examine the barrel for pits or mechanical damage. A barrel that is uniformly pitted but with sharp edges on the lands is considered serviceable. Only those barrels which show excessive wear, developed pits, or which have pits cutting into the lands are considered un-serviceable for overseas shipment by the U.S. Military.

(3) Weapons placed in storage for reissue have more strict a standard. Limits for breechbore and headspace measurements are shown in the serviceability chart (Fig. 96). A few fine pits are acceptable. However, the general appearance of the bore should approximate that of a new barrel and should appear to have a minimum of 75 per cent of normal life left.

THE FIGHTING GARAND

(i) The headspace of a military rifle is measured as the distance between the shoulder of the chamber and the face of the bolt when the bolt is in a locked position. The minimum headspace measurement on the Garand rifles is 1.940 inches. Headspace is important because it affects accuracy and safety. If the weapon has excessive headspace when the round is fired, the thin portion of the case expands and grips the walls of the chamber, while the base of the case moves rearward to fill in the room allowed by the excessive headspace and pulls the case in two. This is called a ruptured case and allows gas to enter the receiver, often severely damaging the weapon. To obtain the headspace measurement, the headspace gage is placed on the face of the bolt and so positioned that the ejector enters the clearance cut on the base of the headspace gage. If the bolt will close fully on a 1.940-inch gage and will not close on the maximum gage as specified by the serviceability chart (Fig. 96), the headspace is satisfactory.

(1) Certain military issue .30-06 gages of early manufacture do not have a bevel around the head of the gage, and are not suitable as interference will be encountered with the fillet around the face of the bolt and erroneous readings will be obtained. Other gages, as ones which are not

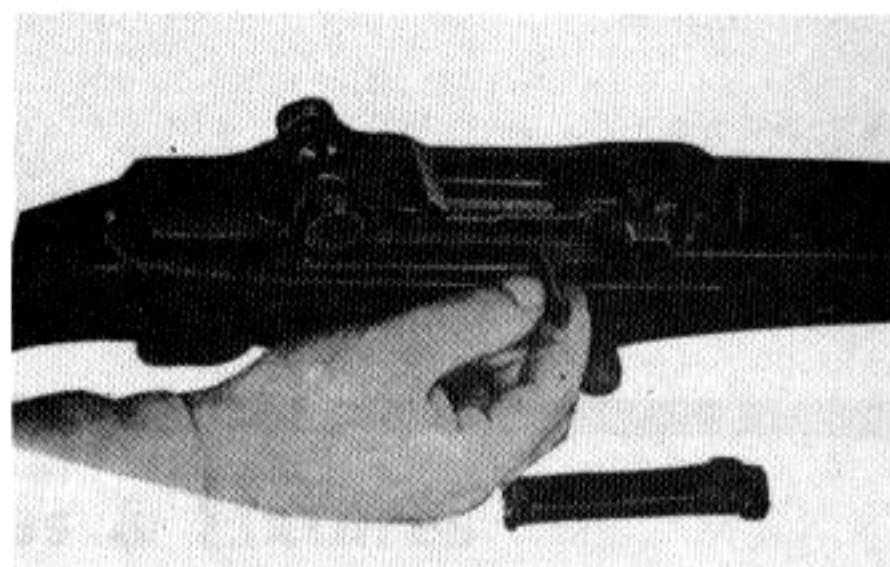

Fig. 97. Checking headspace with test bolt and headspace gage.

military issue, do not have a clearance cut for the ejector. When using these gages, remove the ejector.

(2) The most accurate method of taking headspace is with the operating rod removed, and the reading taken while rotating the bolt lug by hand. If it is found that the headspace of the rifle is over 1.950 inches, check the rifle with the field test bolt (Fig. 97). This will determine whether the excessive headspace is caused by a worn bolt or a worn barrel and receiver assembly. If the field test bolt will not close on a 1.950-inch headspace, the bolt is worn and must be replaced; if the field test bolt will close on a 1.950-inch headspace, the barrel and receiver assembly is worn and must be replaced.

(j) With the action open, inspect the receiver for burrs or other deformation.

(k) Bolt group: test the bolt for freedom, smoothness of movement, and for locking. Insert bolt in receiver and function with fingers.

(l) Stock group:

(1) Inspect the stock for cracks, scratches, bruises or mutilations. Check for loose or bent sling swivels, burrs, a loose front swivel screw, loose or burred stock ferrule, and for loose or missing butt plate screws. Check the seating of the butt plate, function of the butt plate cap, and the tension of the butt plate plunger spring. Make certain the combination tool, oiler, thong case and rifle grease container and/or other accessories are in the butt-well.

(2) Inspect the hand guards for cracks and scoring. Check the ferrule and rear hand guard band for looseness and burrs. Check the lower band for looseness, burrs and loose or missing pin. The pin should be staked. Check the spacer in the front hand guard for position and looseness.

SERVICEABILITY CHART—RIFLES, U. S., CAL. .30; M1, M1C, & M1D			
ITEM	IN THE HANDS OF TROOPS	TO ACCOMPANY TROOPS OVERSEAS	TO BE PLACED IN STORAGE FOR REISSUE
FINISH	Exposed surfaces should be dull enough to prevent glare	Latest enough to prevent glare	Approximate new finish
STOCK	Not damaged to extent that it will affect strength	Seasoned checks, small dents and irregular cracks are acceptable	Approximate appearance of new stock. Should be sandblasted and refinished if necessary. Patch work and reinforcing that does not affect strength is acceptable.
HAND GUARDS	Not damaged to extent that it will affect strength. Loose areas when assembled to rifle is acceptable.	Seasoned checks and cracks which are not at critical points are acceptable. Looseness when assembled to rifle is acceptable.	Seasoned checks and cracks which have been reinforced by pins are acceptable. Looseness when assembled to rifle is acceptable.
BORE	Firing less than the width of lead or groove and less than 3/16" long is acceptable.	Line uniform going out with sharp leads is acceptable.	A few live pits but with sharp leads are acceptable.
BREECH BORE	Max. 0.302	Max. 0.306	Max. 0.305 Use page 41-G-238
BARREL DIA. (OUTSIDE)	Max. 0.5995 Use page 41-G-236	Max. 0.5995 Use page 41-G-236	Max. 0.5995 Use page 41-G-236 RA. PD. 91207

GAS CYLINDER DIAMETER (INSIDE)	Max. 0.5330 Use page 41-G-198-425	Max. 0.5330 Use page 41-G-198-425	Min. 0.5320 Use page 41-G-198-425
HEADSPACE	Min. 1.940 Max. 1.950 Use page 41-G-200-130	Min. 1.940 Max. 1.950 Use page 41-G-200-130	Min. 1.940 Max. 1.948 Use page 41-G-200-100
PISTON DIAMETER	MIN. 0.828	MIN. 0.828	MIN. 0.828
TRIGGER PULL (M1, M1C)	Min. 5 1/2 lb. Max. 7 1/2 lb.	Min. 5 1/2 lb. Max. 7 1/2 lb.	Min. 5 1/2 lb. Max. 7 1/2 lb.
TRIGGER PULL (M1D, M1C & M1D)	Min. 4 1/2 lb. Max. 5 1/2 lb.	Min. 4 1/2 lb. Max. 5 1/2 lb.	Min. 4 1/2 lb. Max. 5 1/2 lb.
FIRING PIN PROTRUSION	No check	No check	Min. 0.044 Max. 0.059 Use page 41-G-182-350

Fig. 96. Serviceability chart (U.S. military specs).

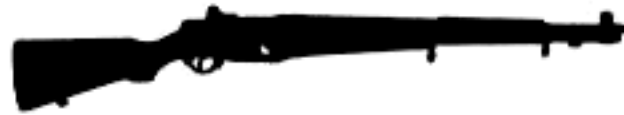

VI. Tools, Gages & Fixtures

Section 1, General

32. Complete overhaul and repair of a complicated and precision mechanism such as a semi-automatic rifle is best accomplished by the use of certain special tools, gages and fixtures. Many small gun or ordnance shops may not have all the special tools used by the U.S. military, but these tools are illustrated herein to show the proper type of tools that should be used, and the most expedient methods of using them. They vary from tools which are issued, tools and fixtures which are made up, and common tools. Plans are shown also for the fabrication by gunsmith or ordnance shops of the tools and fixtures which aid in the repair of quantities of rifles, which may not be necessary for the repair of single rifles. The illustration of the tools used by military installations is intended to serve as a guide for correct improvisation, and the illustration of their use to serve as a guide for proper methods.

Section 2, Non-Improved Tools, Gages and Fixtures

33. Gages:

(a) Breech bore gage (fsn 41-G-28) (Fig. 98). The breech bore gage is used to determine wear of the bore at the origin of rifling. This gage has ten graduations, each of which corresponds to .001 inch of wear. The tenth graduation or point marked "reject" is equivalent to a bore diameter of .310 inch, since the zero graduation is .300 inch. Use of this gage is described in Para. 31 (h).

(b) Gas cylinder diameter gage (fsn 41-G-198-425). This gage is of the plug type. It is relieved on two sides in order to check for out-

of-roundness as well as for oversize diameter. The gage checks only the origin of the cylindrical portion of the gas cylinder, as this portion has been found to be the one that determines whether or not the cylinder allows the weapon to function properly (Fig. 98).

(c) Barrel diameter at gas port, no-go gage (fsn 41-G-236). This gage is used to check the diameter of the barrel at the gas port (Fig. 98).

(d) Piston gage, no-go (fsn 41-G-236-85). This gage is used to check the diameter of the gas piston (Fig. 98).

(e) Headspace Gages (Fig. 98) are used to check the distance between the shoulder of the chamber and the face of the bolt. Headspace gages are in three sizes namely: 1.940 inches (fsn 41-G-200-75), 1.946 inches (fsn 41-G-200-100) and 1.950 inches (fsn 41-G-200-130) in length. Later models of these gages have been revised to provide a 45 degree bevel of the heads. If these are used note to see if they are of the later type with beveled heads and with a clearance cut for the ejector. If they are not, the ejector must be re-

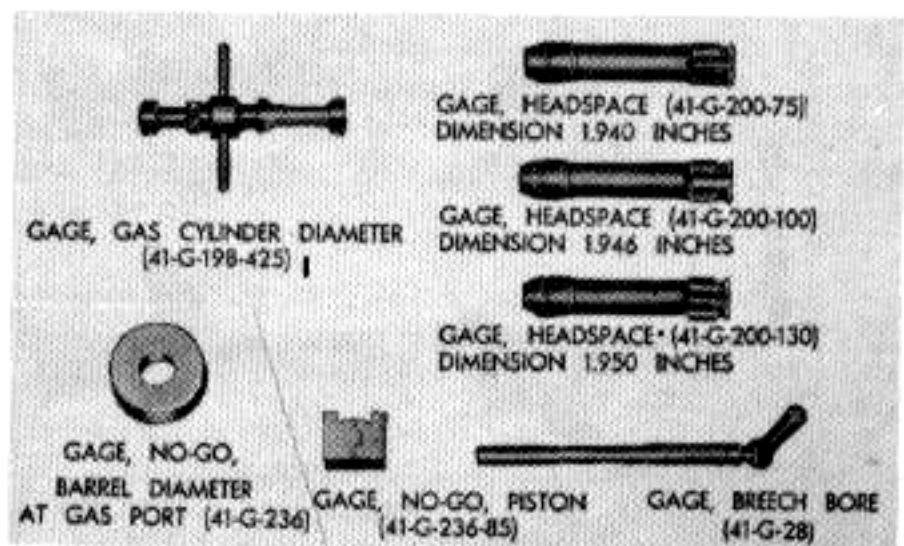

Fig. 98. Gages.

THE FIGHTING GARAND

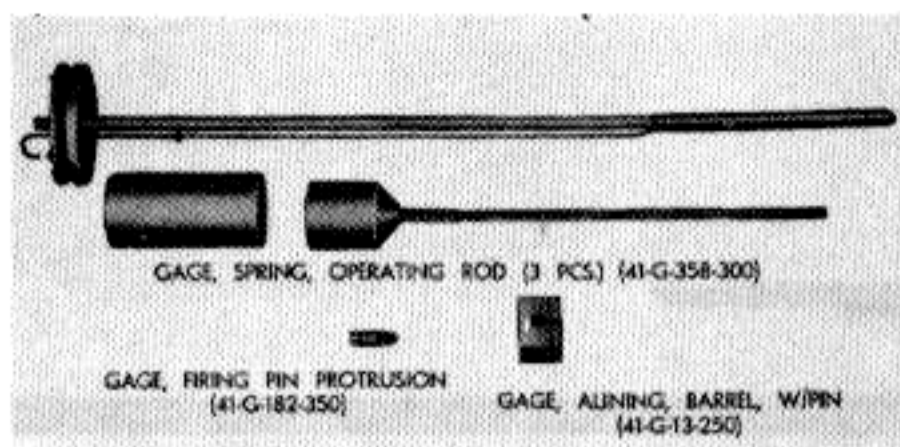

Fig. 99. Gages.

moved from the bolt before gaging. Use of the headspace gage is described in Para. 31 (i).

(f) Barrel aligning gage, with pin (fsn 41-G-13-250). The barrel aligning gage is used to check the alignment of the barrel to the receiver (Fig. 99).

(g) Firing pin protrusion gage (fsn 41-G-182-350). The firing pin protrusion gage is used to check the protrusion of the firing pin beyond the face of the bolt (Fig. 99).

(h) Operating rod spring gage, with 5- and 11-pound weights (fsn 41-G-358-300). This gage is used for gaging the load and free height of the operating rod spring (Fig. 99).

34. Tools:

(a) Field test bolt (fsn 41-B-1587) is used in conjunction with the headspace gage to determine whether the chamber, bolt, or bolt lug seats in the receiver are worn (Fig. 100).

(b) Rear sight pinion punch (fsn 41-P-3788). The rear sight pinion punch is three inches long and has a diameter of .057 inch. It is used to stake the rear sight elevating pinion to prevent loss of the rear sight nut when in service (Fig. 100).

(c) Barrel reflector (fsn 41-R-2331). The barrel reflector is used to provide a light reflecting

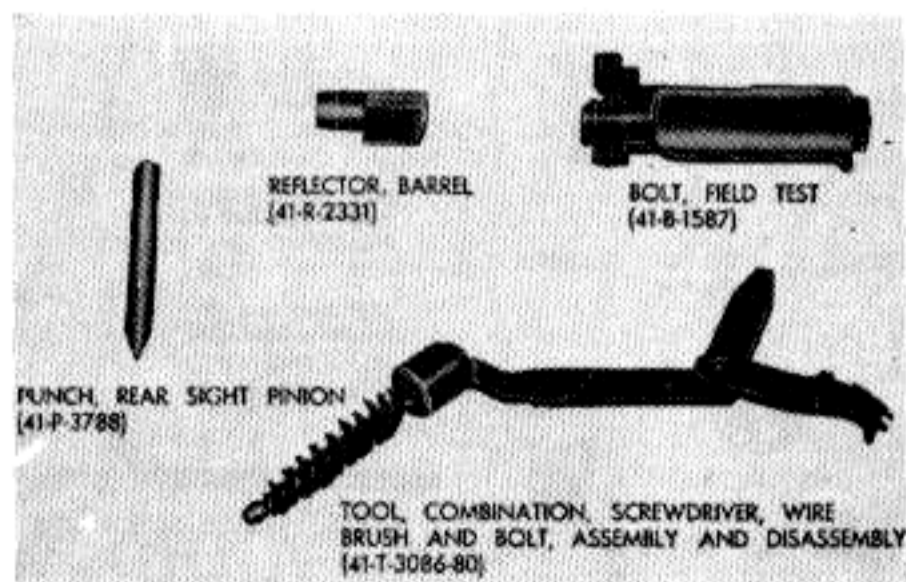

Fig. 100. Tools.

surface for visual inspection of the bore. It is placed in the chamber and, by holding the rifle so that light is reflected properly, the bore, including the chamber, can be inspected (Fig. 100).

(d) Combination screw driver, wire brush and bolt disassembly and assembly tool (fsn 41-T-3086-80). This tool, as the name implies, is a combination of tools which may be used to perform the following operations in the rebuilding or maintenance of the rifle.

(1) Remove and replace the gas cylinder lock screw and various other screws, and seat the rear sight base.

(2) Extract the cartridge case.

(3) Remove pins and assemble the extractor and ejector.

(4) Assemble or disassemble the extractor and ejector without removing the bolt from the rifle.

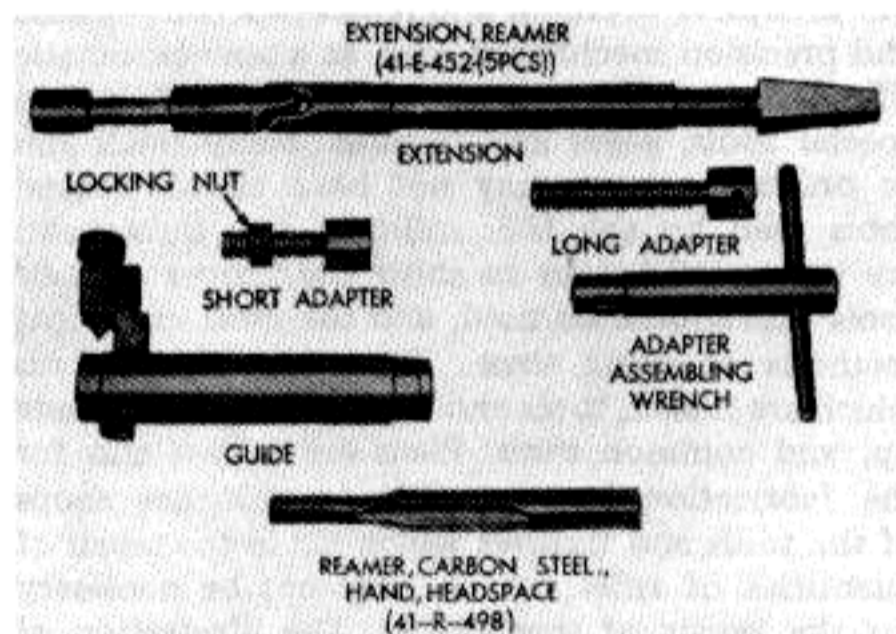

Fig. 101. Tools used for reaming headspace.

(5) Clean the chamber of the rifle.

(6) Install the extractor spring and plunger.

(e) Reamer extension (Fig. 101), (fsn 41-E-452) is used as a guide or fixture in reaming the headspace. It consists of five parts:

(1) Reamer adapter with long and short locking nuts: a reamer is assembled to the adapter and locked by the locking nut. The adapter is the connecting piece for the universal-jointed extension unit. Adapters are furnished in two lengths to allow the use of reamers after they have become shortened as a result of repeated sharpening.

(2) Adapter assembling wrench: this tool is used to assemble the reamer adapter to the reamer and hold it while the locking nut is being tightened.

(3) Guide: the guide is used as an alignment piece and as a stop for the reamer. It is secured

THE FIGHTING GARAND

in the receiver by a thumb screw having a point on the threaded end. Tightening the thumb screw forces the guide back against the locking lugs, which is necessary to insure uniform headspace reaming.

(4) Universal-jointed extension: this unit is provided with a tapered square shank to be used with a brace.

(f) Carbon steel hand headspace reamer (fsn 41-R-498) is used for reaming headspace when rifles are being rebarreled. It is used with headspace reamer extension as described above (Fig. 101).

(g) Barrel and receiver disassembly wrench and fixture (fsn 41-W-3875). This fixture and wrench are used in disassembling the barrel and receiver assembly. The barrel is passed into the fixture, muzzle end first, and located so that the rib in the barrel stops against a shoulder in the fixture. This fixture holds the barrel firmly while the receiver is turned counter clockwise with a special wrench (Fig. 102).

(h) Windage screw knob wrench (fsn 41-W-3852) is an adjustable split socket which can be adjusted to fit tightly on the elevating knob or windage knob. A crank is attached (Fig. 102) to facilitate rotating the rear sight knobs when disassembling and assembling the rear sight.

(i) Gas cylinder lock assembling wrench (fsn 41-W-1496-250) is used to remove an extremely tight gas cylinder lock from a rifle, and is designed to fit the contours of the lock (Fig. 102). It is intended to be used for assembling the lock to the rifle.

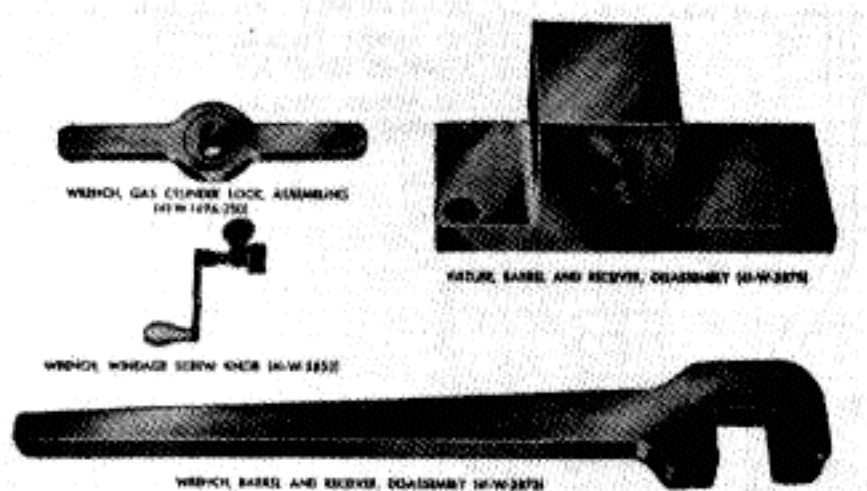

Fig. 102. Disassembly and assembly tools.

35. Fixtures:

(a) Barrel and receiver assembling fixture (fsn 41-F-2987-250) is used to draw the barrel in correct relation to the receiver in order to prevent binding of the operating mechanism of

the rifle and to position the barrel properly so the front sight will have the proper relation with respect to the rear sight. It is equipped with clamping facilities to hold the receiver in a fixed position; a pointer and an index, which are attached to splined portion of barrel, are provided to assure correct alignment when draw is made (Fig. 103).

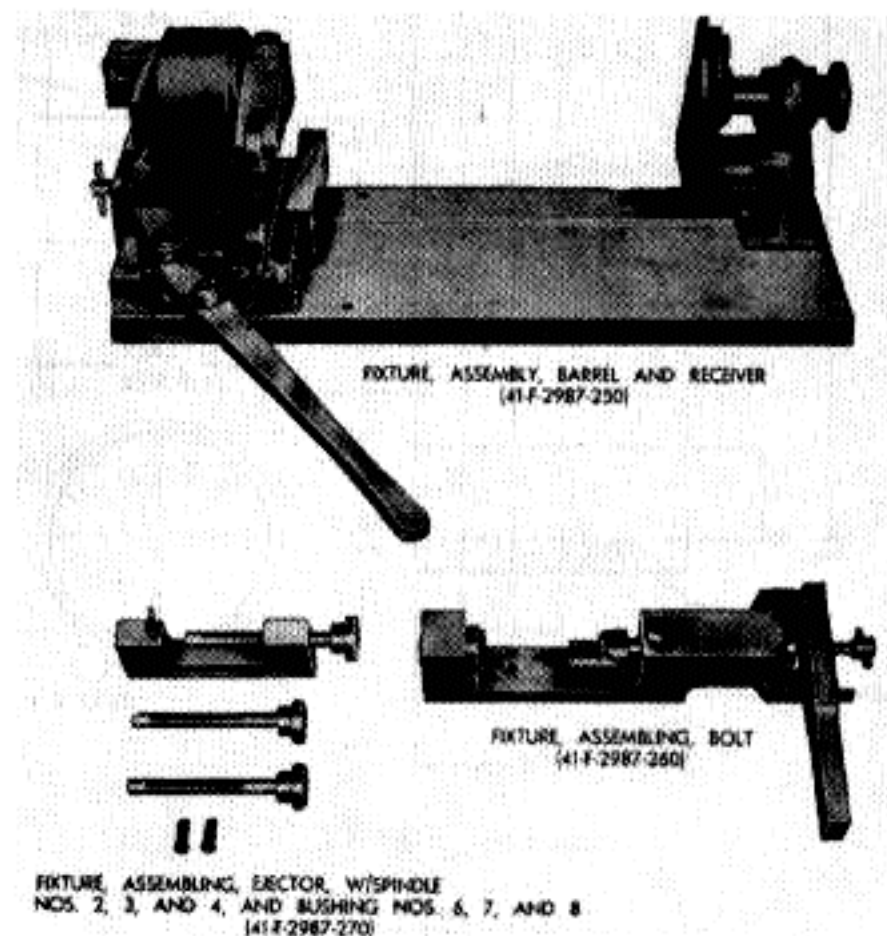

Fig. 103. Fixtures.

(b) Bolt assembling fixture (fsn 41-F-2987-260) is a clamp used to install the extractor in the bolt. It can be held in a vise or permanently fastened to the armorer's bench. The bolt, with its component parts, is clamped in place in the fixture. The fixture is designed so it will align the cut in the ejector with the extractor hole in the bolt, making it (Fig. 103) possible to install the extractor.

(c) Ejector assembling fixture, with spindle, Nos. 2, 3, 4, and bushing Nos. 6, 7, 8. This fixture is used to assemble the ejector, extractor, and rear sight springs to their respective components (Fig. 103).

Section 3, Improvised and Shop-Made Tools, Gages and Fixtures

36. The following tools, gages and fixtures can be made or improvised, to assist in the inspection and repair of Garand rifles:

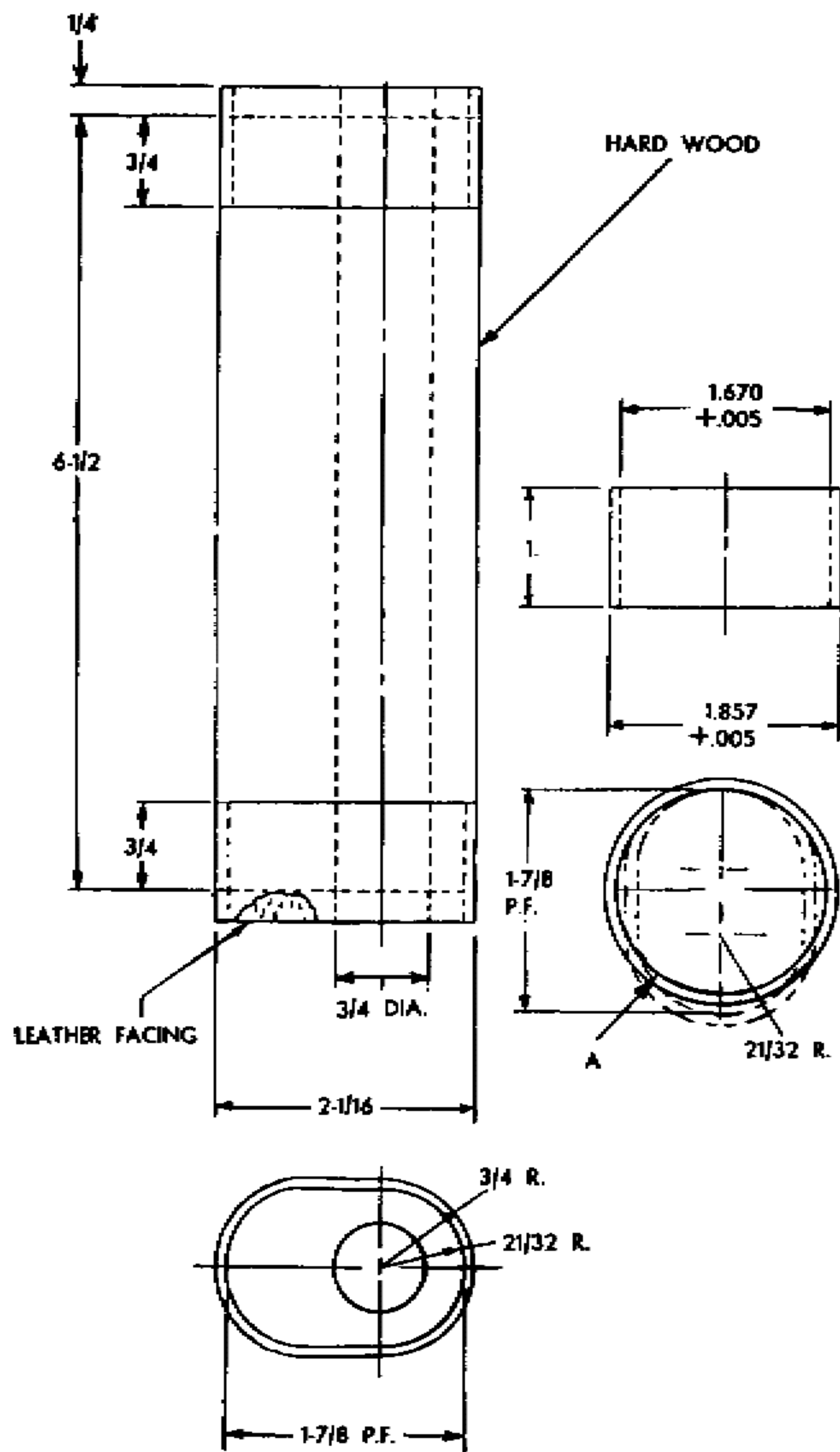

A—MACHINE FROM STEEL TUBING AND FLATTEN AS INDICATED BY PHANTOM LINES.

Fig. 104. Lower band driver.

(a) Lower band driver (Fig. 104). This tool is used to seat the lower band. It is made from hard wood, and the ends covered with leather to provide a surface that will not mar the finish of the ferrule.

(b) Trigger pull weights (Fig. 105). Four weights of 4 1/2, 5 1/2, 6 1/2 and 7 1/2 pounds respectively are used to check trigger pull. Each of these weights should be provided with a rod which is long enough to clear the stock so the pressure will be exerted parallel to the axis of the bore and rigid enough to retain an L-shaped hook

not less than 2 1/4 inches long when supporting the weight.

(c) Pliers (Fig. 106), are used to assemble or remove the band on the rear hand guard.

(d) Trigger housing assembling fixture (Fig. 107), is used as an aid when seating the trigger pin when assembling the trigger housing.

(e) Swaging roll (Fig. 108), is a rolling tool used to swage the metal of the barrel to eliminate looseness of the barrel in the receiver.

(f) Height gage (Fig. 109), is used to measure the depth of the cut when modifying the operating rod.

(g) Depth gage (Fig. 110), is used to measure the fillet cut and is provided with a scribe line to ascertain the starting point of the cut.

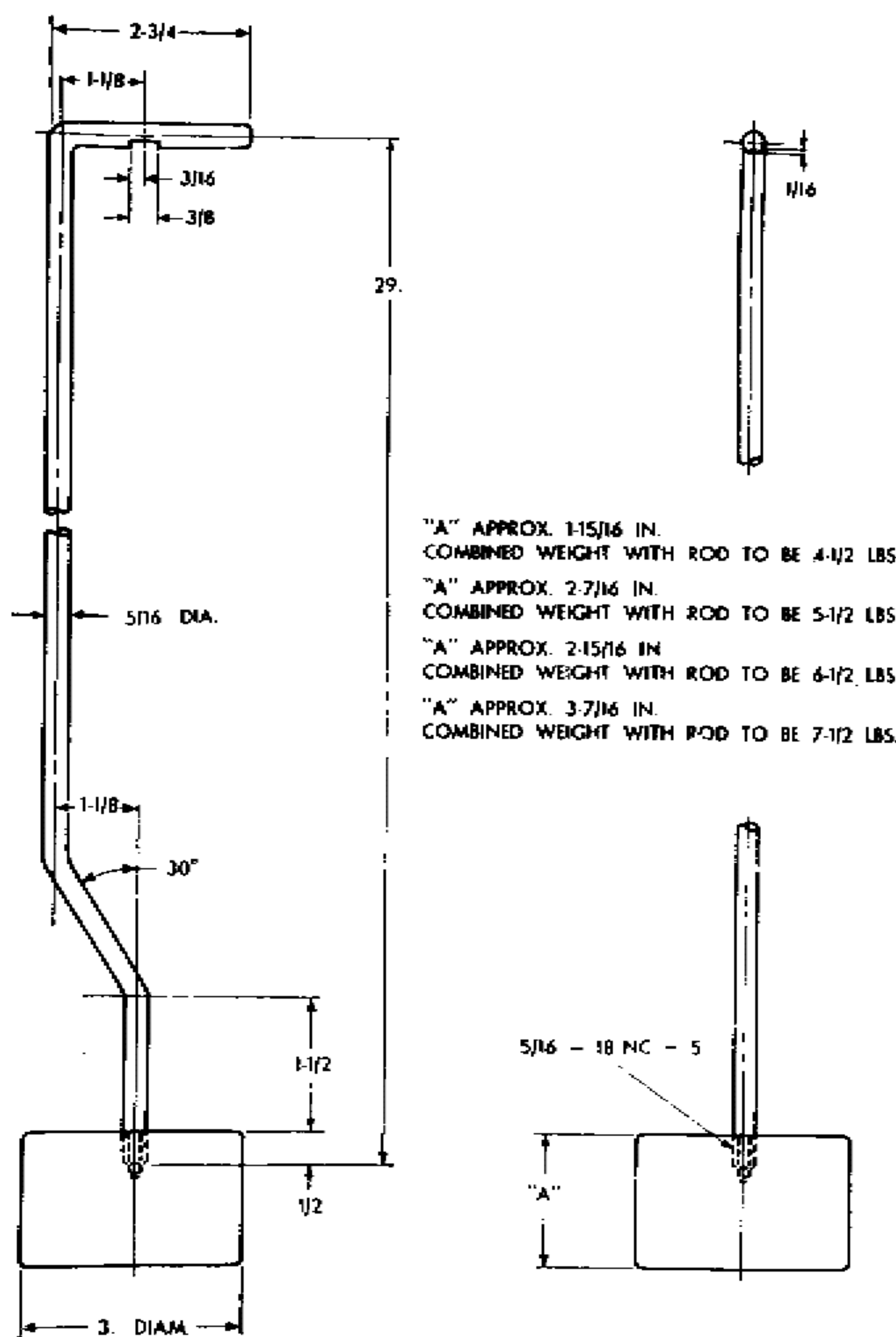

"A" APPROX. 1-15/16 IN. COMBINED WEIGHT WITH ROD TO BE 4-1/2 LBS.
 "A" APPROX. 2-7/16 IN. COMBINED WEIGHT WITH ROD TO BE 5-1/2 LBS.
 "A" APPROX. 2-15/16 IN. COMBINED WEIGHT WITH ROD TO BE 6-1/2 LBS.
 "A" APPROX. 3-7/16 IN. COMBINED WEIGHT WITH ROD TO BE 7-1/2 LBS.

Fig. 105. Trigger pull weights.

THE FIGHTING GARAND

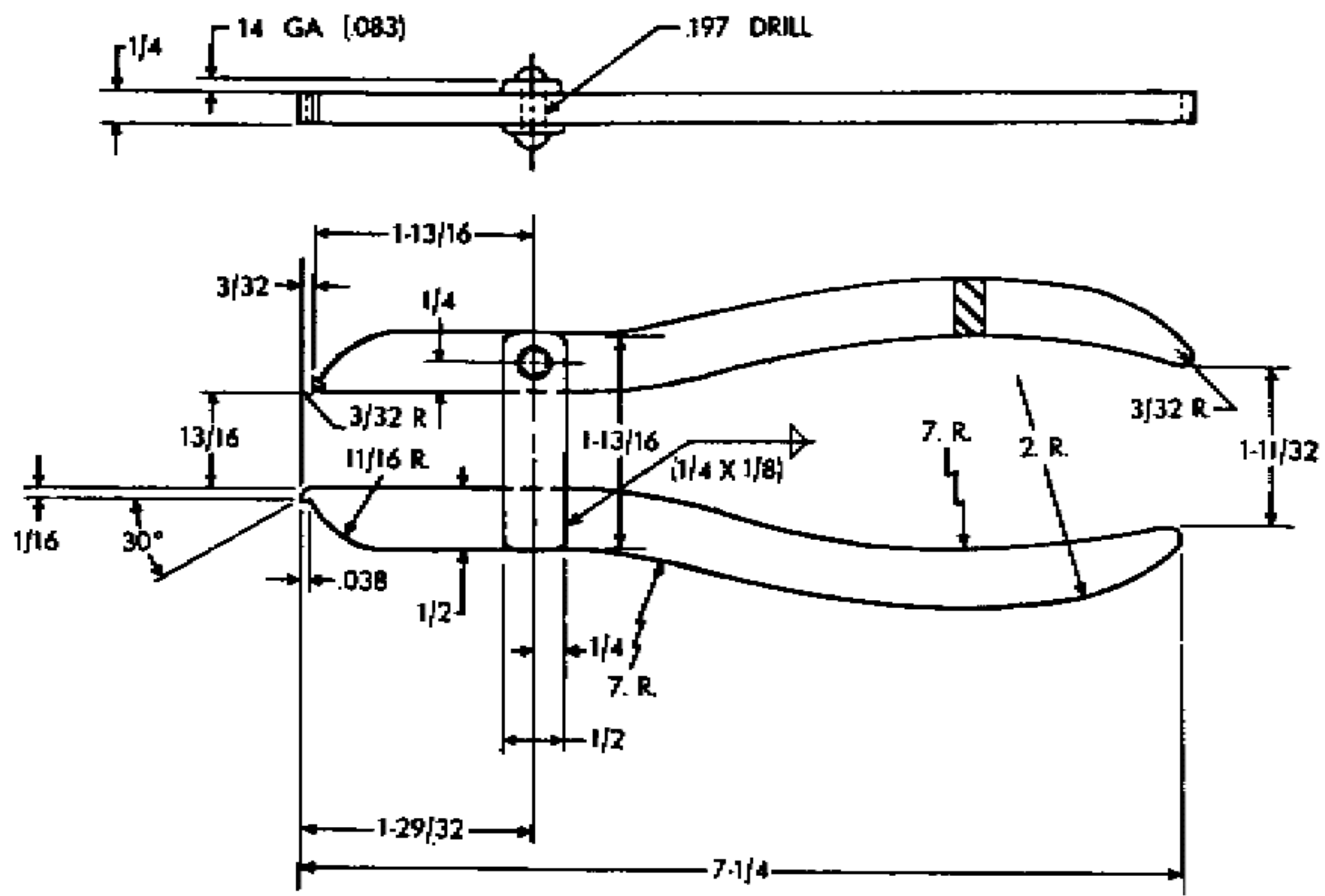

Fig. 106. Pliers (rear band of hand guard).

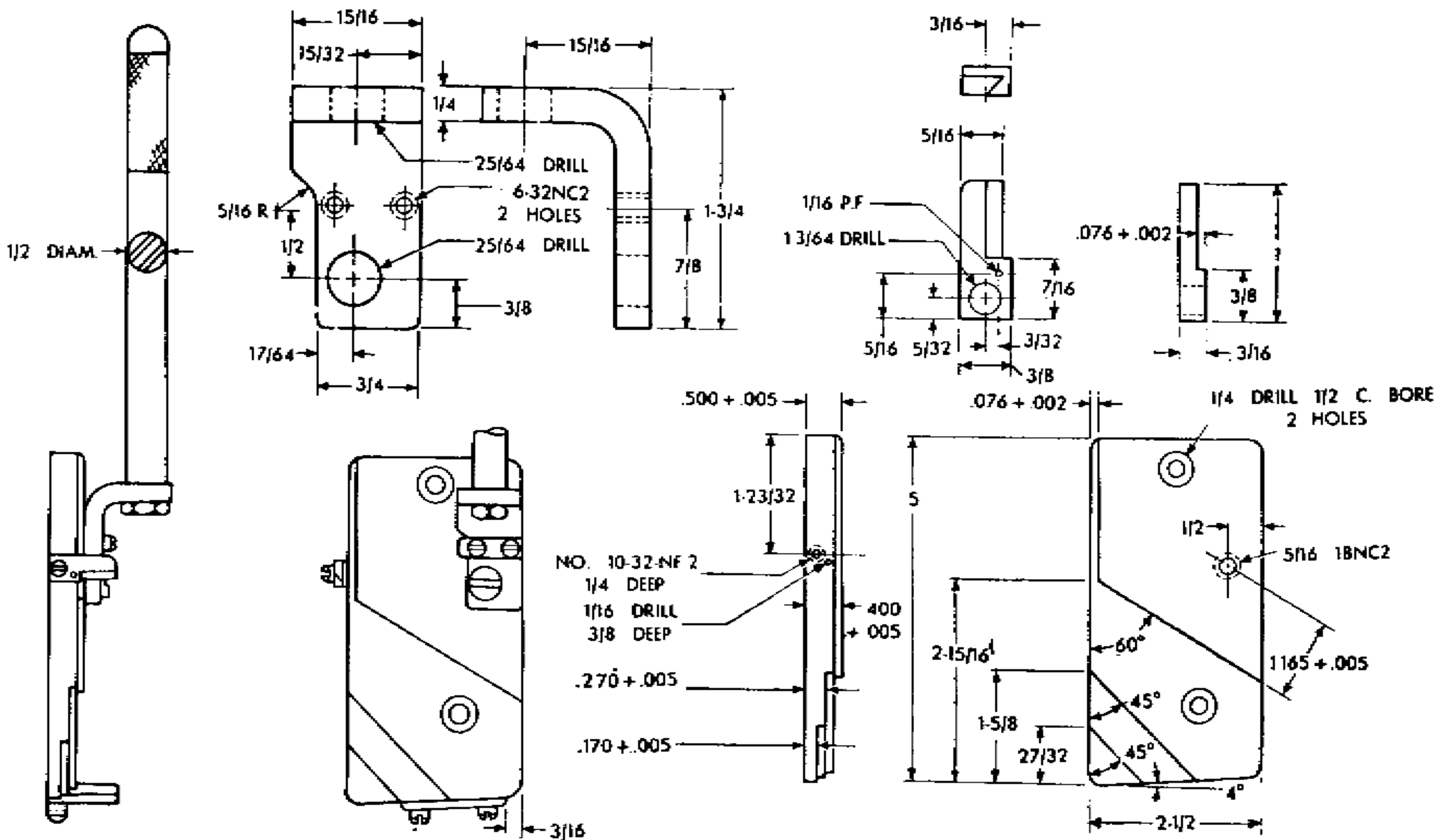

Fig. 107. Trigger housing assembling fixture.

THE FIGHTING GARAND

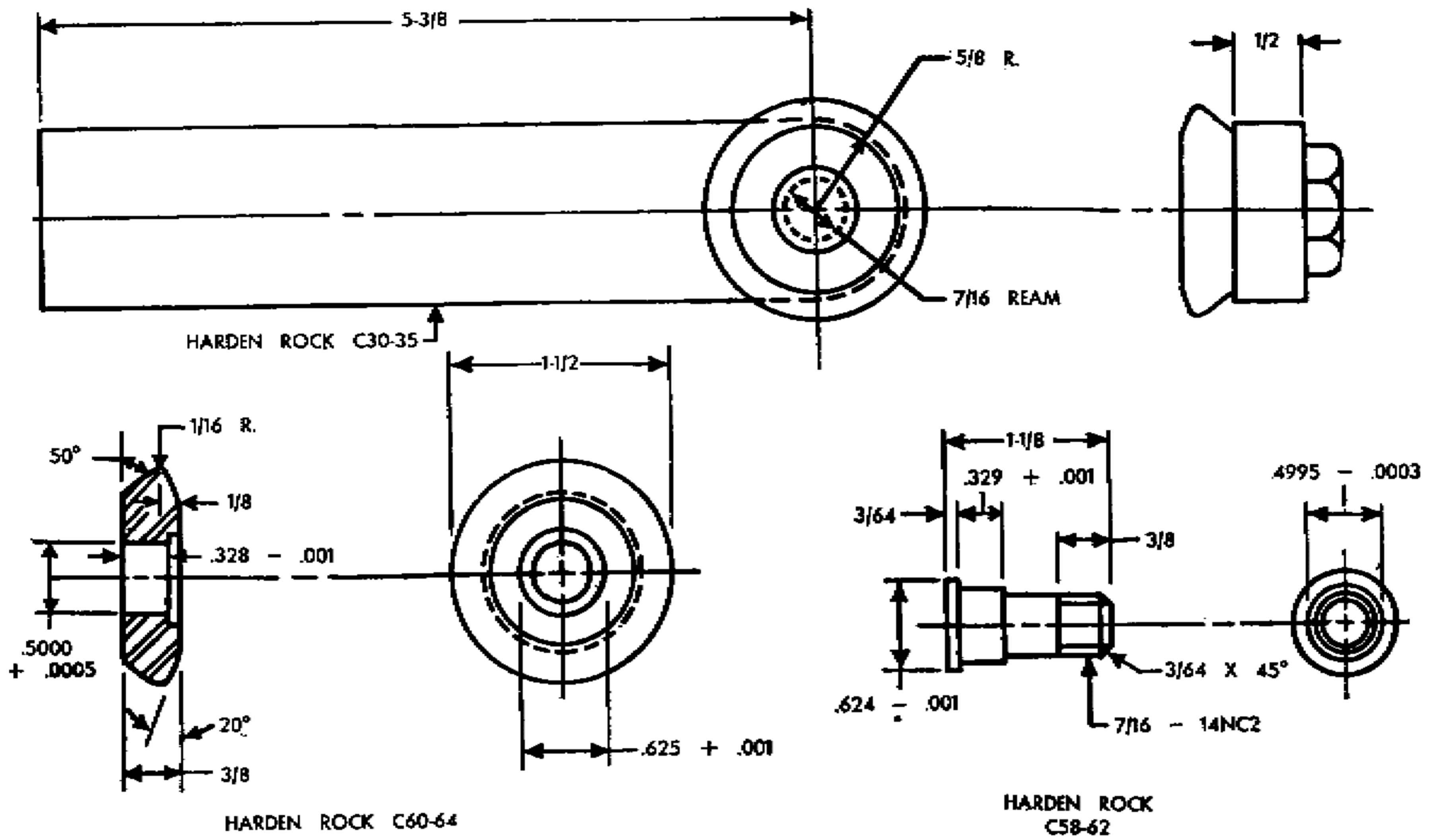

Fig. 108. Barrel & receiver swaging roll.

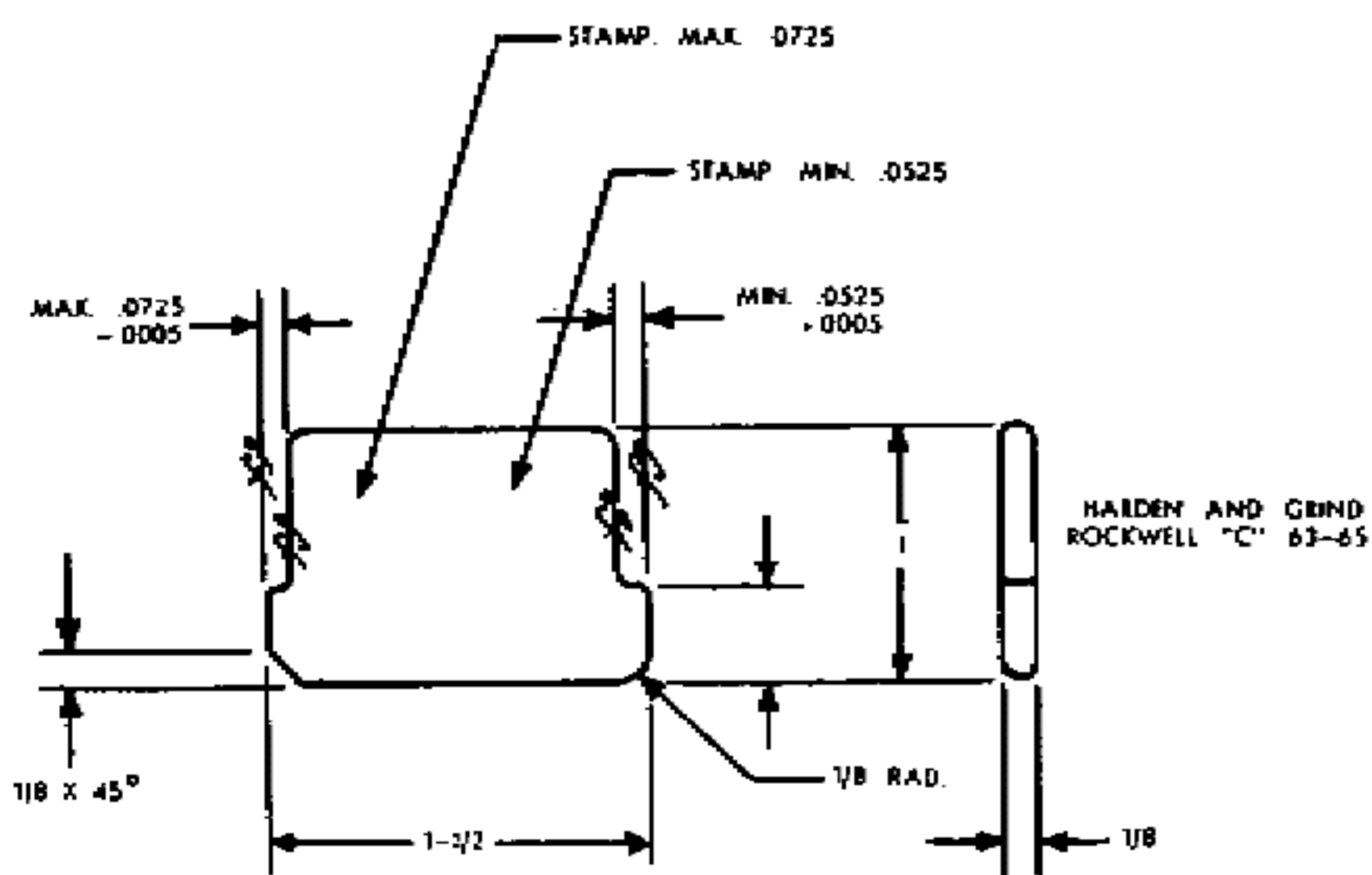

Fig. 109. Height gage.

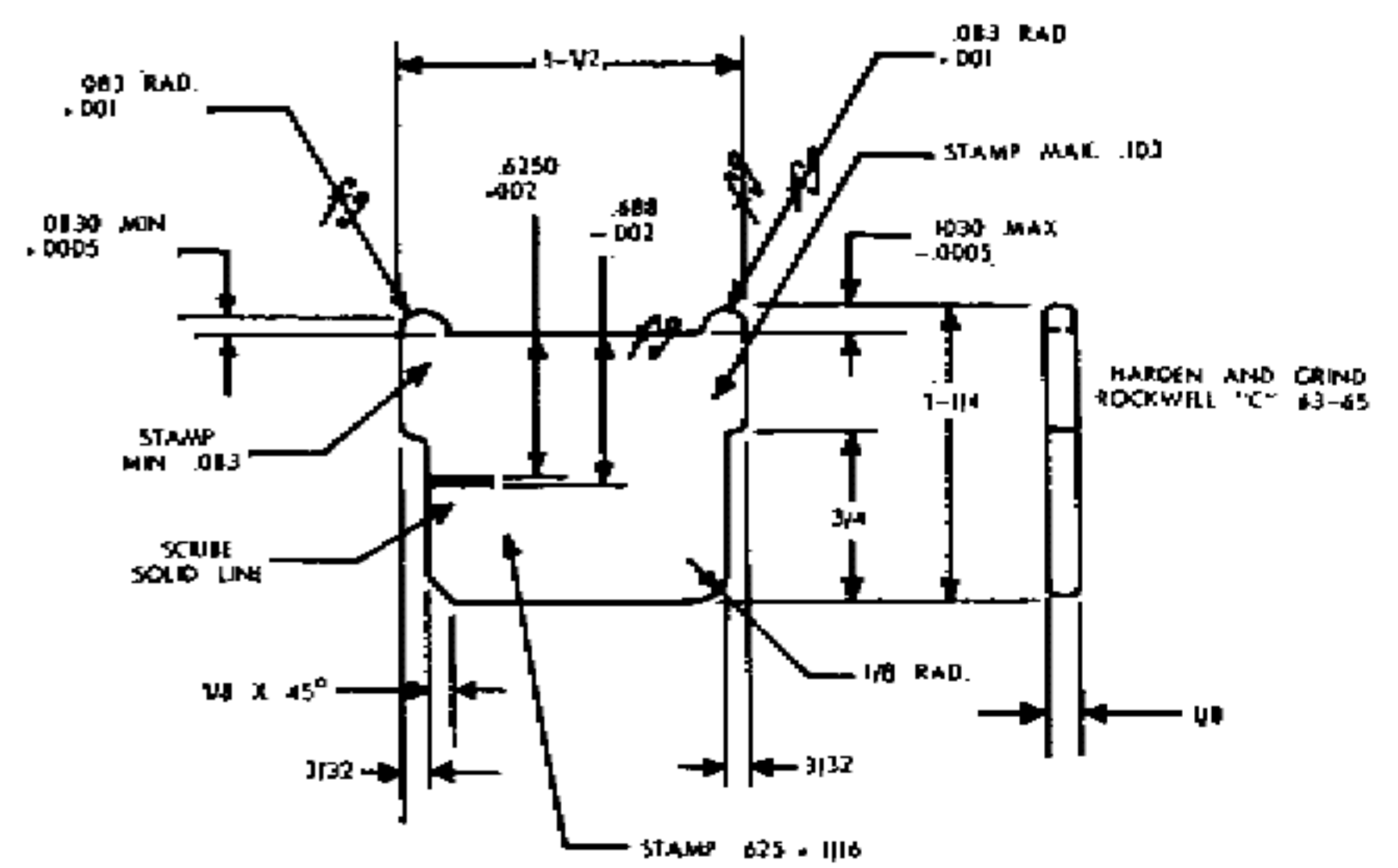

Fig. 110. Depth gage.



VII. General Maintenance

Section 1, General

37. This chapter contains general maintenance information which may be applied generally to the group or assemblies covered in the following Chapters. For convenience and clarity, the main groups of the rifle (trigger housing barrel and receiver, and stock) are covered in separate sections; equipment is also covered separately in the last chapter.

38. General methods:

(a) Place all parts and assemblies on a clean, flat surface, of wood if possible, to avoid damaging parts. Keep the parts for one individual gun separate from those of other guns.

(b) If a production line procedure is used for several rifles, keep the barrel and receiver, the operating rod, and the bolt together. This reduces to a minimum the time required for fitting bolts and operating rods to the rifle, since in most cases those assembled in the rifle when it is returned for rebuild were fitted by the manufacturer. This can be accomplished by wiring the components to the barrel as they are removed.

(c) Replace weak or broken springs and worn, damaged or broken parts before assembly and testing.

(d) When possible, assemble subassemblies before mounting them on the weapon. As a part of assembling and mounting operations, clean and lubricate all sliding surfaces and threads to assure free movement.

(e) Remove all burs with a fine file or by stoning and polishing with crocus cloth. Take care to file or stone evenly and lightly and not to remove any more metal than is necessary so as not to change the tolerance or contour of the surfaces so treated.

(f) Remove burs, rough protrusions, or scorings of wood surfaces with a fine, flat file or fine abrasive paper. Always file towards an edge so as not to pick up slivers or chips. Smooth off with fine sand paper where necessary, and oil with raw linseed oil.

39. Maintenance and repair of the rifles usually consists mainly of replacement of worn or broken parts. When a large number of rifles are being reconditioned, it is more efficient to have different operations performed by certain personnel, i.e., have stations where the rifles are disassembled and visually checked, taken to another station and gaged and tested, a third station for certain types of rebuild and so on. All rifles should be function fired and inspected thoroughly after being rebuilt.



VIII. Barrel & Receiver Group

Section 1, Disassembly

40. General: remove and disassemble the barrel and receiver group as outlined in Para. 24.

41. Removing the barrel from the receiver (Fig. 113). The barrel should be removed from the receiver only when necessary. To remove, pass the barrel into the fixture, muzzle end first, until the rib on the barrel stops against the shoulder in the fixture. Position the wrench on the receiver

as near the barrel as possible and unscrew the barrel in a counterclockwise direction (never place the wrench on the back of the receiver, as there is danger of warping it).

42. Follower and slide assembly: disassemble the follower and follower slide (Fig. 111) only when necessary to repair or replace parts. If necessary to disassemble, insert the blade of a screwdriver under the front end of the slide (Fig. 114), pry upward and forward, unlocking the slide from the follower.

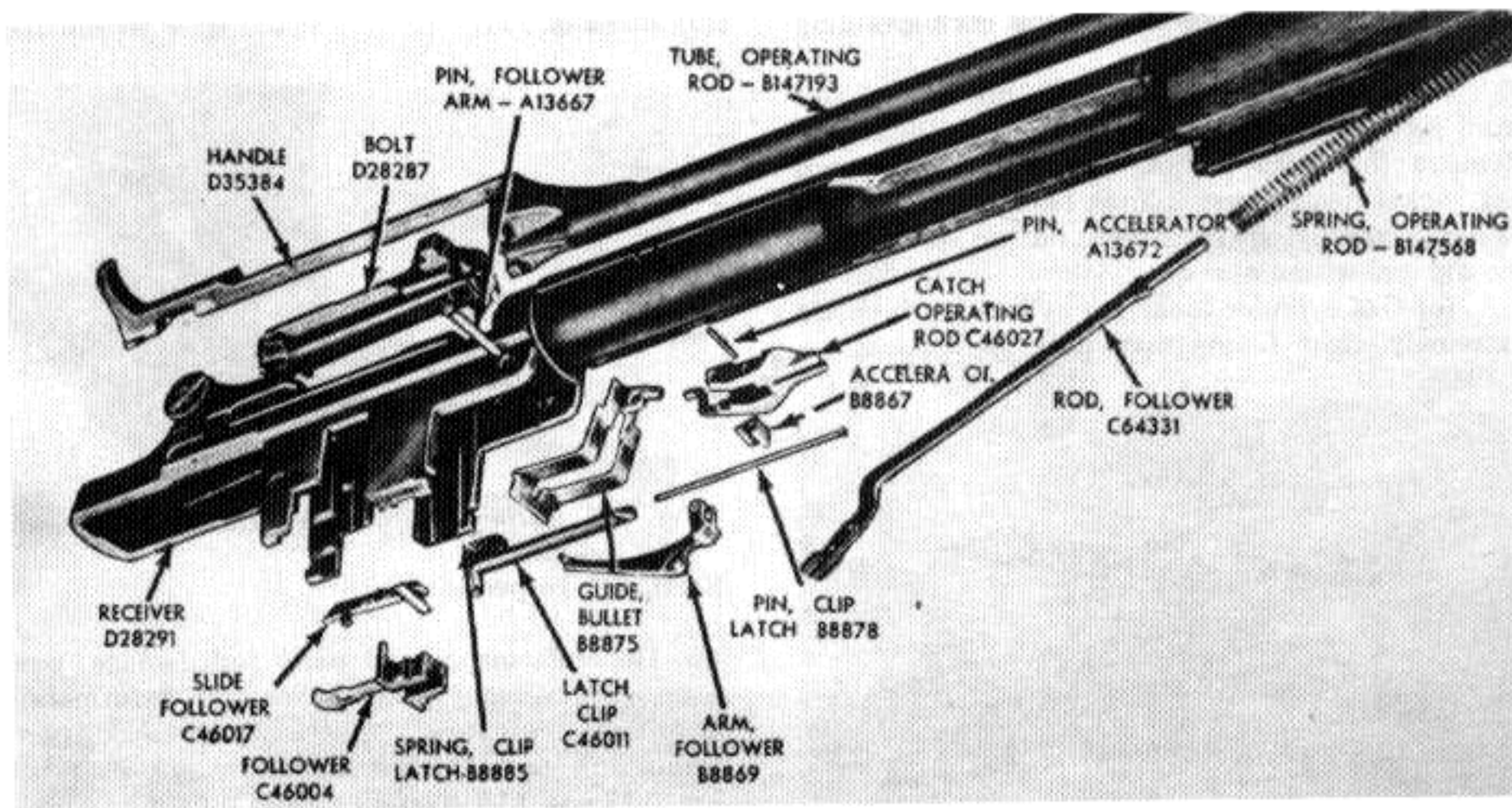

Fig. 111. Receiver group - disassembled view.

THE FIGHTING GARAND

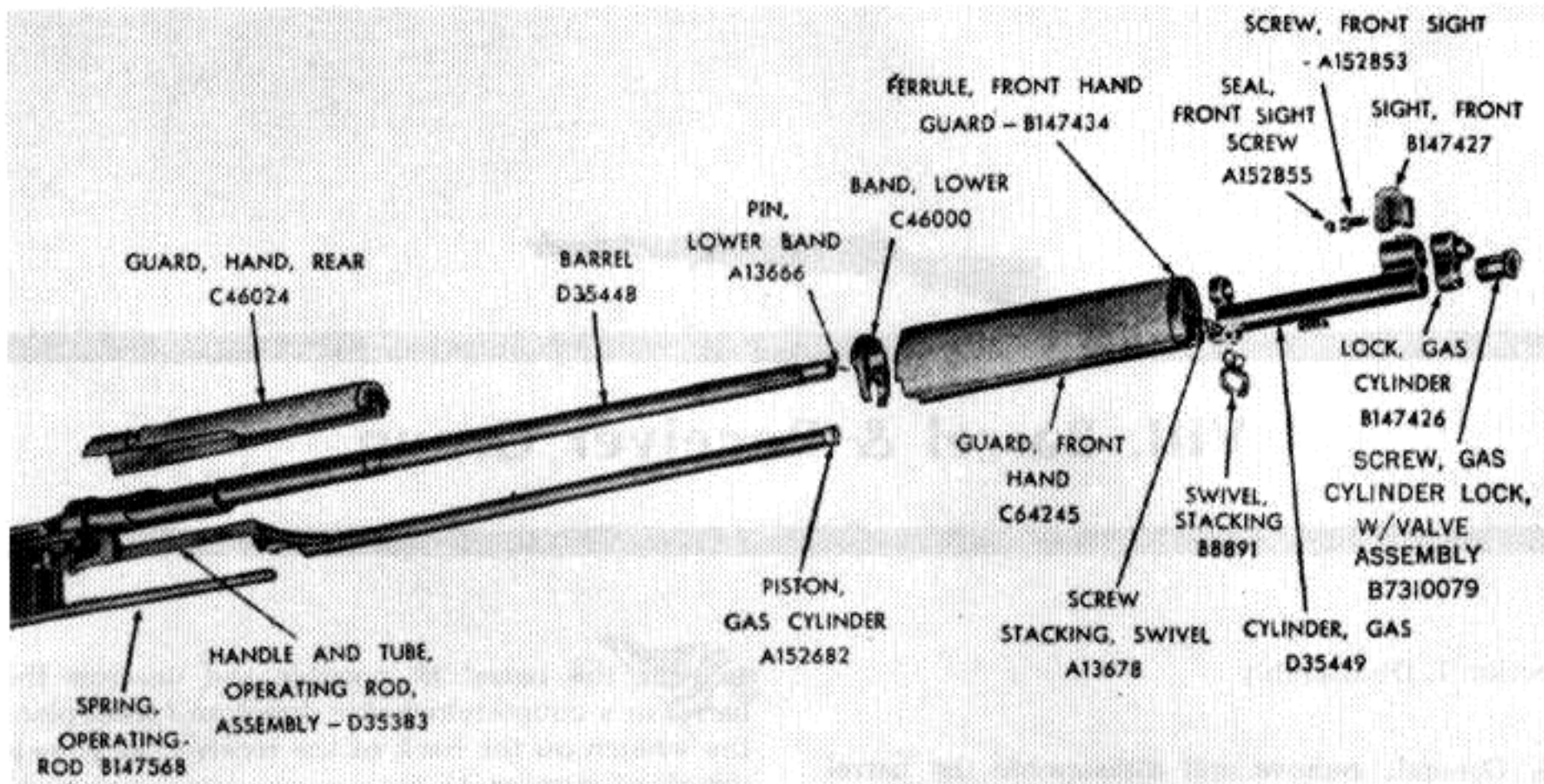

Fig. 112. Barrel, with gas cylinder (spline type), hand guards, and operating rod assembly.

43. Gas cylinder group:

(a) Front sight screw: loosen the front sight screw (Fig. 112) before removing the gas cylinders which have been modified (by having a cut extending from the front sight base dovetail downward to the lower splines) to avoid damage to the splines on the gas cylinder or the corresponding grooves in the barrel.

(b) Front sight screw seal: on some older front sight screws, there is a seal cap on the screw. Remove this with a file, and with a 3/16-inch hex socket head screw wrench back out the screw. Replace and tighten the screw, but do not replace the old seal with a new one.

(c) Gas cylinder lock: gas cylinders which are extremely tight fitting may have their locks re-

moved by the use of the gas cylinder lock wrench. Fit the wrench over the contour of the gas cylinder lock and unscrew counterclockwise (Fig. 115).

44. Removing and installing the extractor without removing bolt from rifle (see Para. 24 (f) (3) and (5), and Fig. 116).

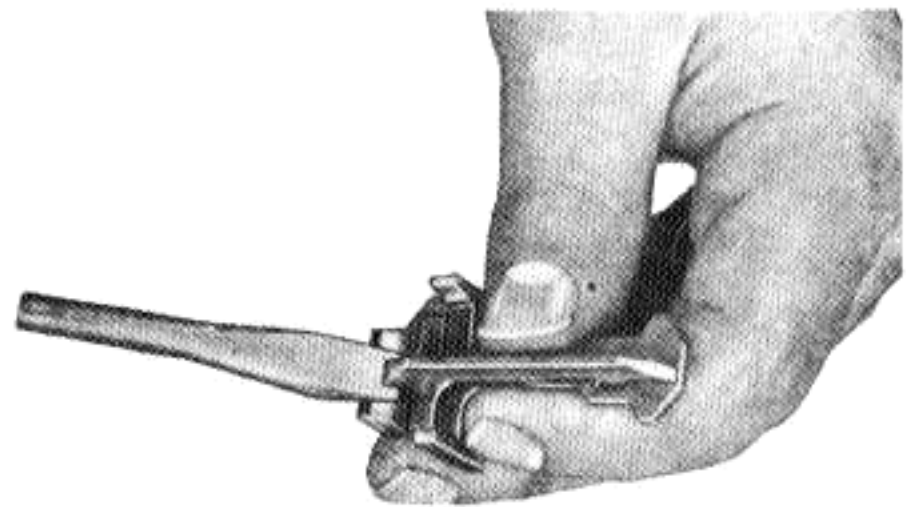

Fig. 114. Removing follower slide from follower.

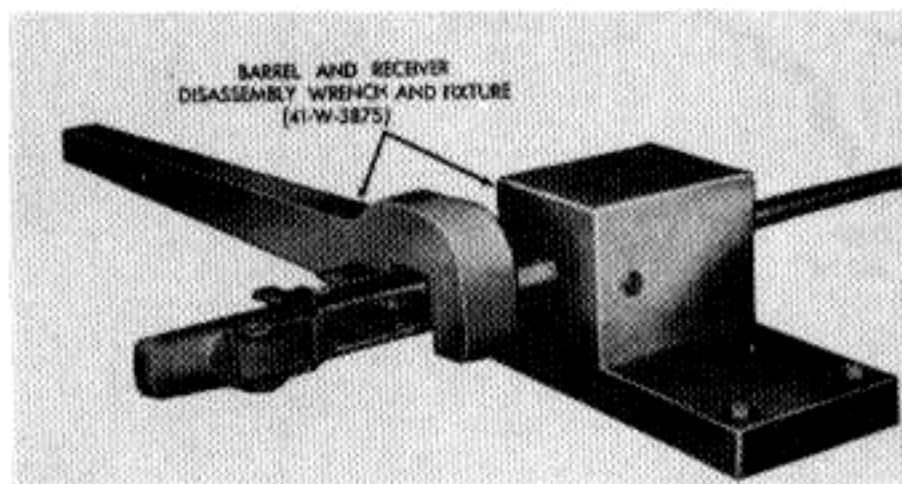

Fig. 113. Removing barrel from receiver.

Section 2, Inspection

45. General: inspect all parts for damage, wear, burs, rust, foreign matter in recesses, deformation, and for function and free action with mating parts. Important parts to be inspected are shown in Fig. 117 and 118. Test all springs for set, minimum length, and fractures.

THE FIGHTING GARAND



Fig. 115. Removing gas cylinder lock.

46. Follower rod: inspect the follower rod (Fig. 118) for a pinched or worn fork and for loose rivets. The follower rod should have a long fork; therefore, replace all rods having short forks (see Fig. 119). This is necessary to prevent the rod from disengaging when grenades are being launched.

47. Operating rod spring: inspect the operating rod spring for free length and load in the following manner:

(a) Testing for free length: insert the operating rod spring in tube of gage and raise rod until bottom of stop collar is flush with top surface of

gage (see Fig. 120). Note position of operating rod spring in regard to top face of tube. If spring does not protrude beyond face of tube, the maximum free length of 20 1/4 inches is satisfactory and the spring is serviceable in regard to free length. With the spring still in the tube, allow the rod to return to its original position and test for load.

(b) Testing load: insert the end of 5-pound weight in tube of gage and allow its weight to compress the spring. It should compress between 16 3/4 and 17 3/4 inches which is indicated by the first 1-inch relief notch cut in the stem of the weight. Note position of this notch in regard to top face of tube. If top face of tube falls within the limits of the relief notch (Fig. 121), the load at

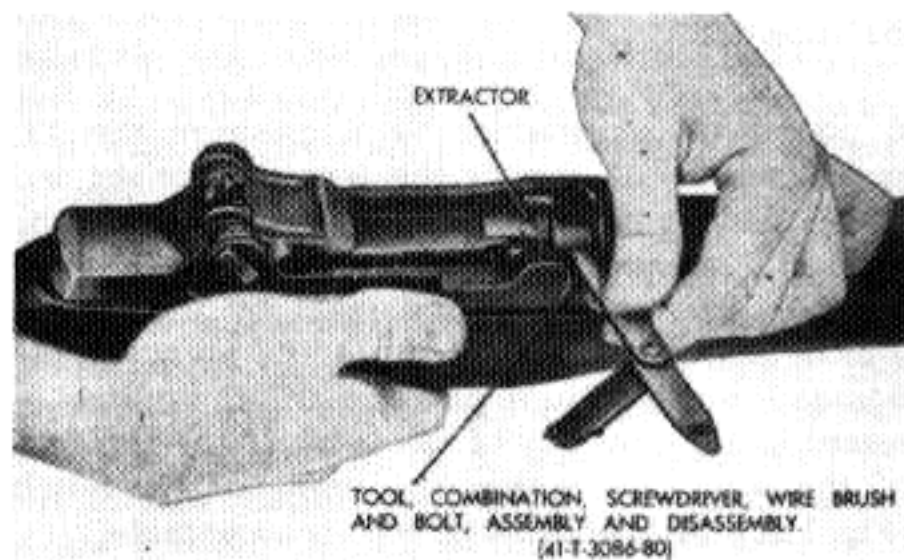

Fig. 116. Removing extractor, bolt in rifle.

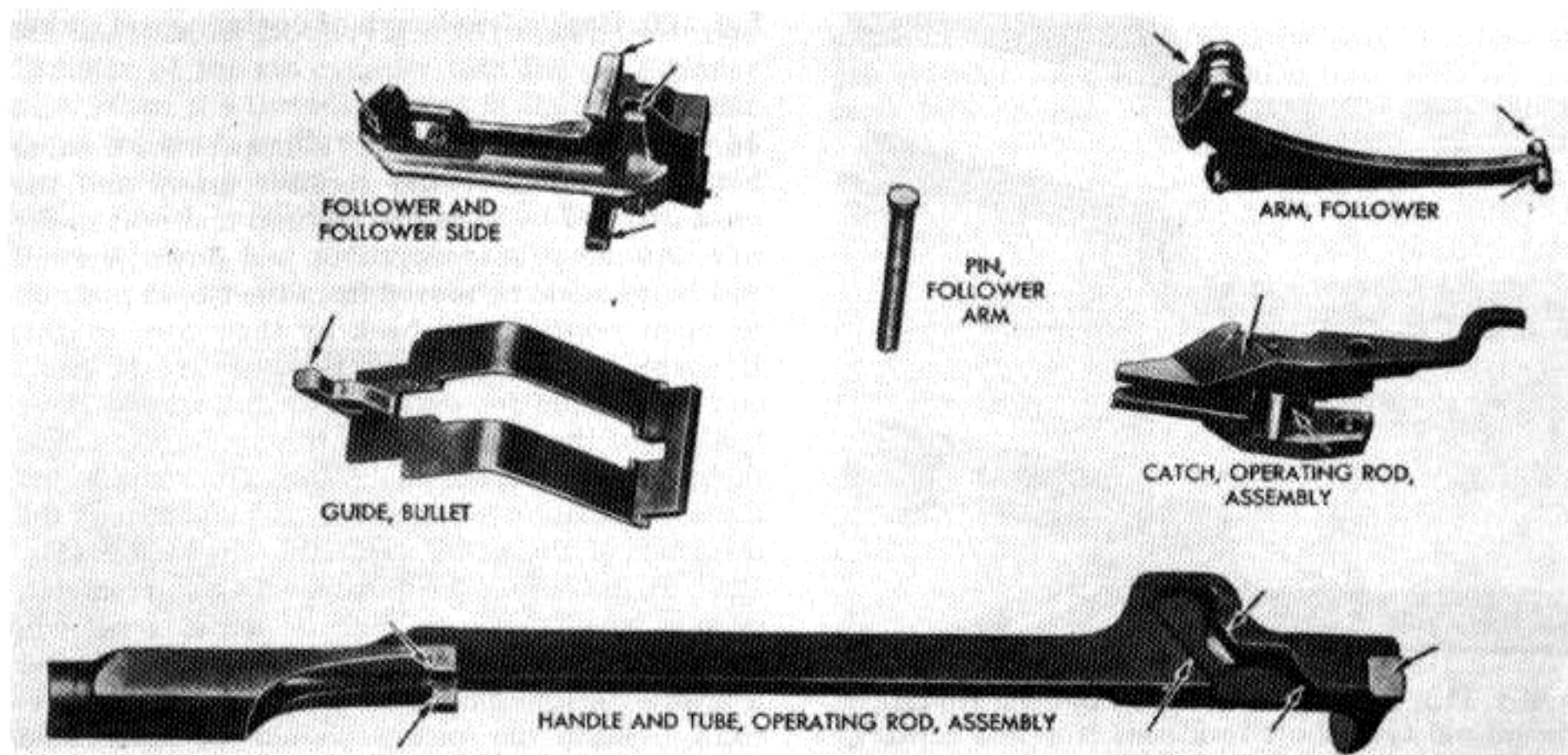

Fig. 117. Receiver group - points to inspect.

THE FIGHTING GARAND

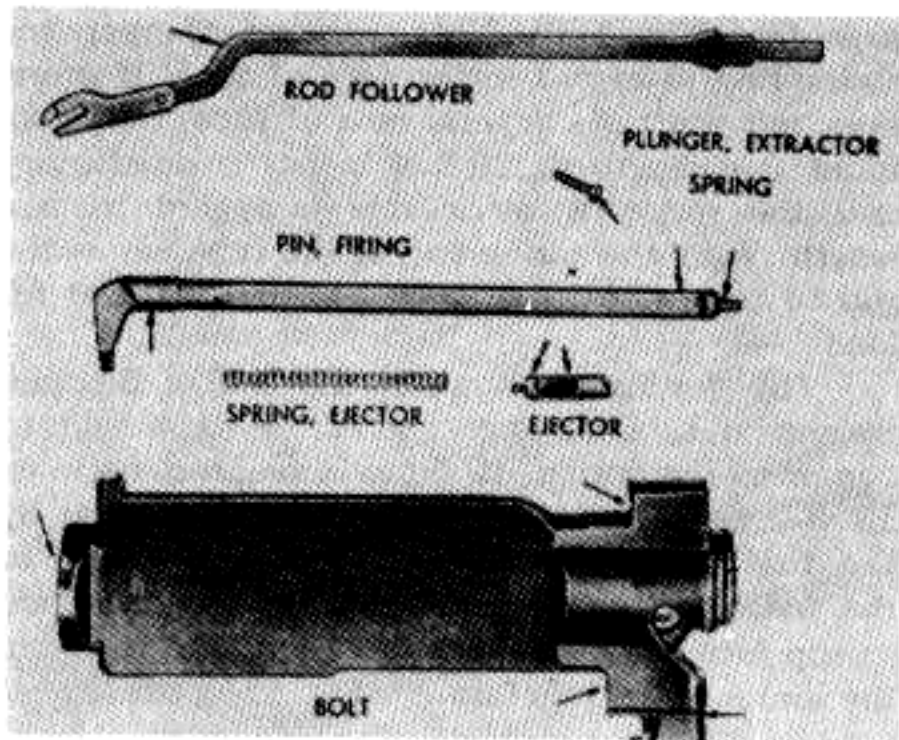

Fig. 118. Follower rod and bolt group points to be inspected.

5 pounds is acceptable. Next, position the 11-pound weight on top of the 5-pound weight and allow their combined weight to compress the spring. It should compress between 11 3/4 and 12 3/4 inches which is indicated by the second 1-inch long relief notch cut in the stem of the 5-pound weight. Note position for this notch in regard to the top face of the tube. If the top face of the tube falls within the limits of the notch (Fig. 121) the load at 16 pounds is acceptable.

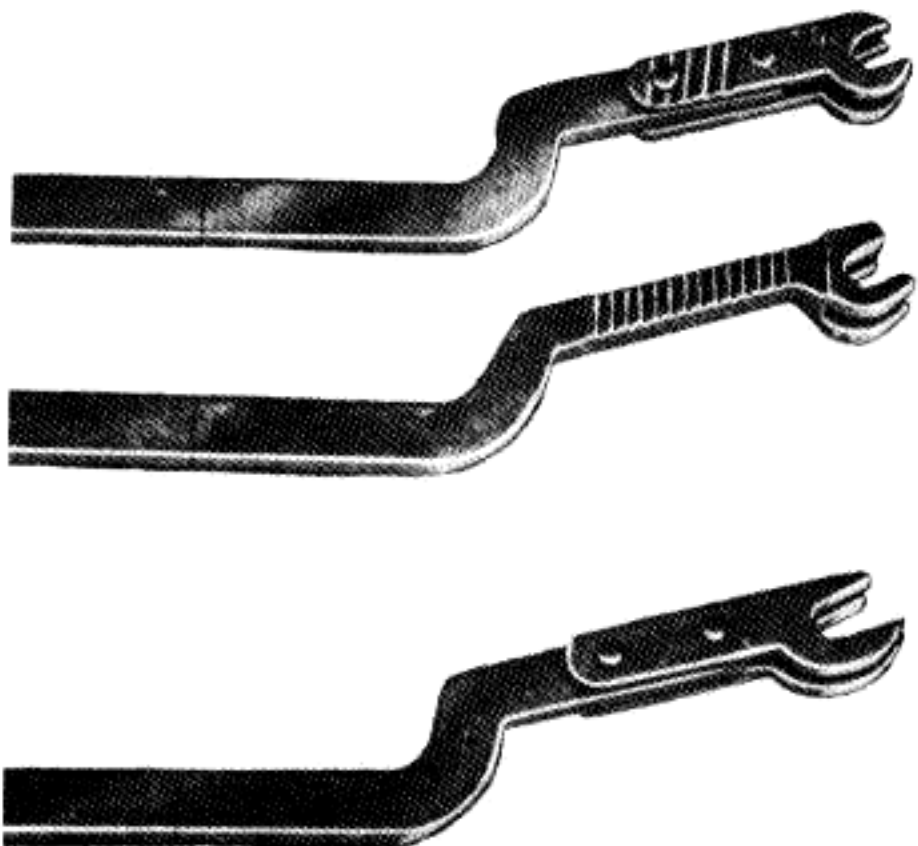

Fig. 119. Old and New Type Follower Rods. Discard old type short fork rods (top and center), install new type long fork rod (bottom).

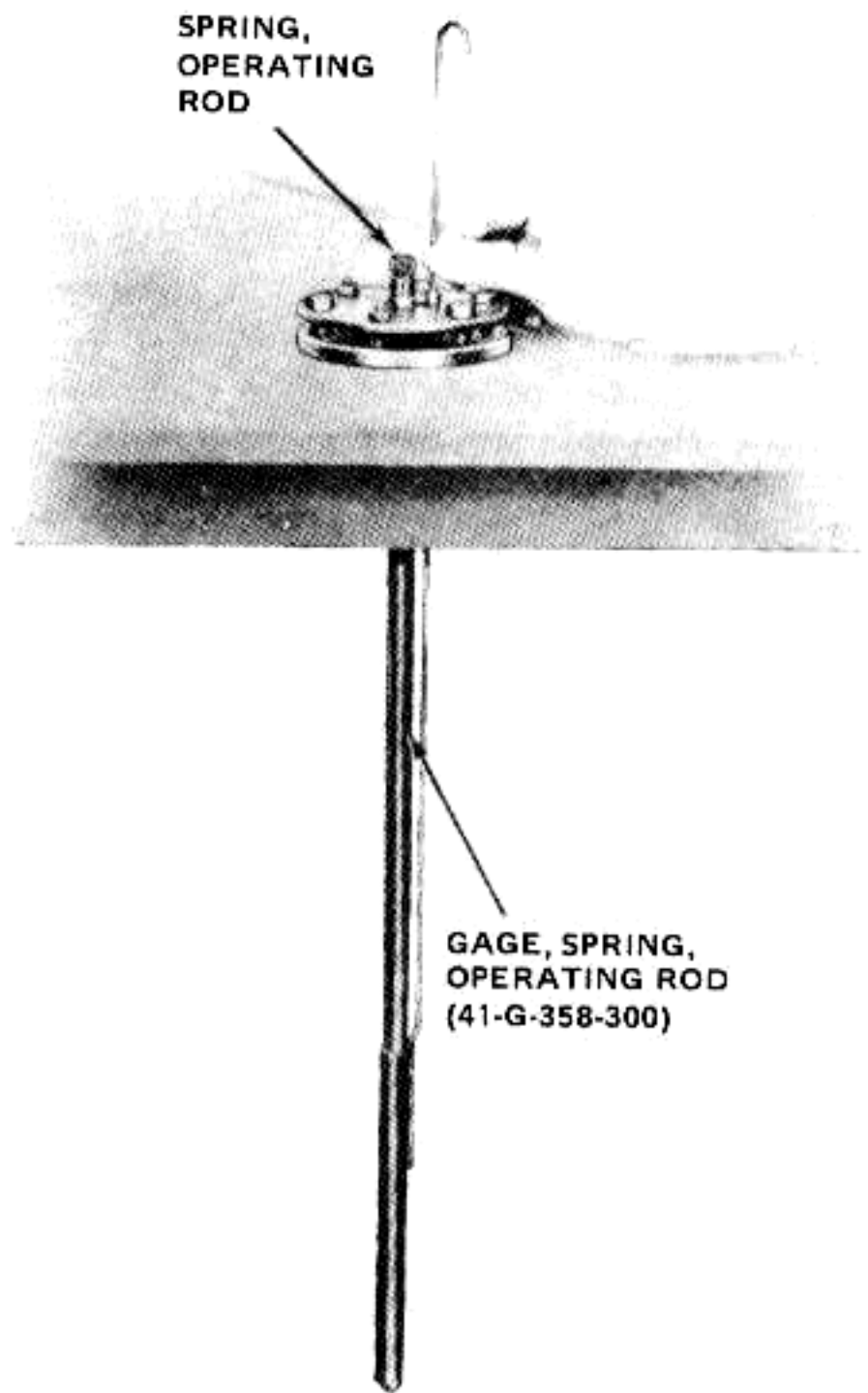

Fig. 120. Gaging free length of operating rod spring.

48. Operating rod (Fig. 117): inspect for binding between the barrel and receiver group and the operating rod by installing the rod and bolt in the rifle. As the rifle is tipped up and down, the rod and bolt should be moved from the closed position to open position and back by their own weight. If there is binding, inspect the tube for dents and the handle for deformation, which will cause binding of the under side of the lug on the cut in the receiver. Inspect the piston for scoring and the accumulation of excessive carbon. Inspect the diameter of the piston with the no-go gage (Fig. 122). If measuring the piston with a micrometer, pistons which measure .525 or more inches will be considered serviceable. If the piston diameter is below the minimum as shown on the serviceability chart, the piston should be considered unserviceable.

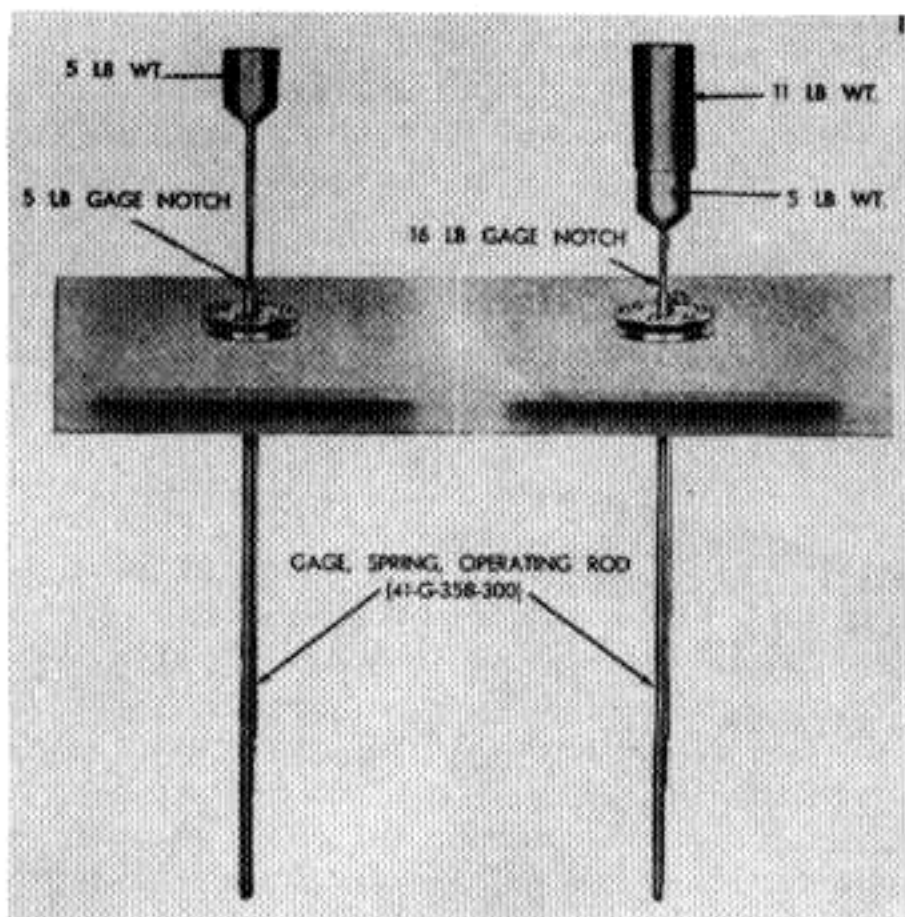

Fig. 121. Gaging load of operating rod spring.

49. Follower and follower slide (Fig. 117). Inspect the slides on follower for correct angle. An angle of approximately 92 degrees plus or minus 0 degree 20 minutes must be maintained (Fig. 123).

50. Rear sight pinion (early manufacture). Inspect the pinions visually. Pinions having cracks caused by staking need not be removed, provided they do not interfere with functioning (Fig. 124).

51. Gas cylinder group (Fig. 125). Check the inside diameter of the gas cylinder with the gas cylinder gage. When the threads are cut in the gas cylinder the metal tends to flow and the inside diameter of the threaded section is reduced; therefore, this section must be slightly reamed to allow the gage to be inserted. Use the reamer on one end of the gage to perform this operation. Only the wire edge

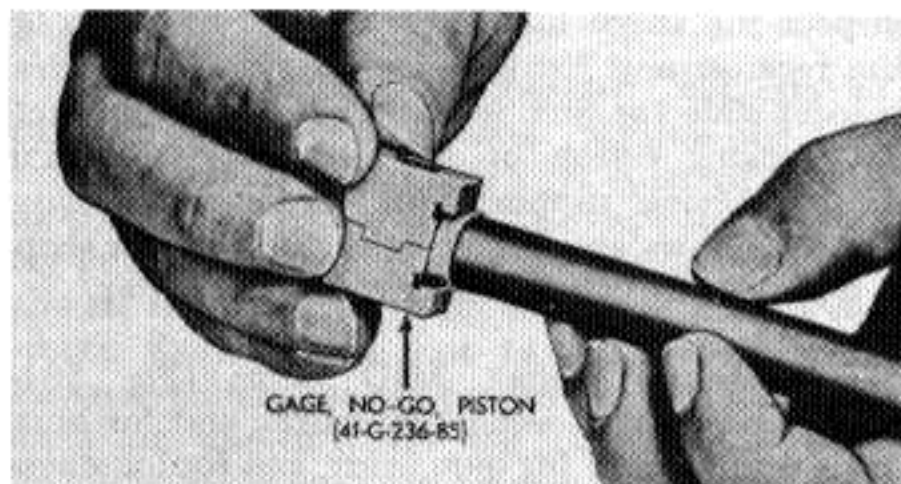

Fig. 122. Gaging diameter of piston.

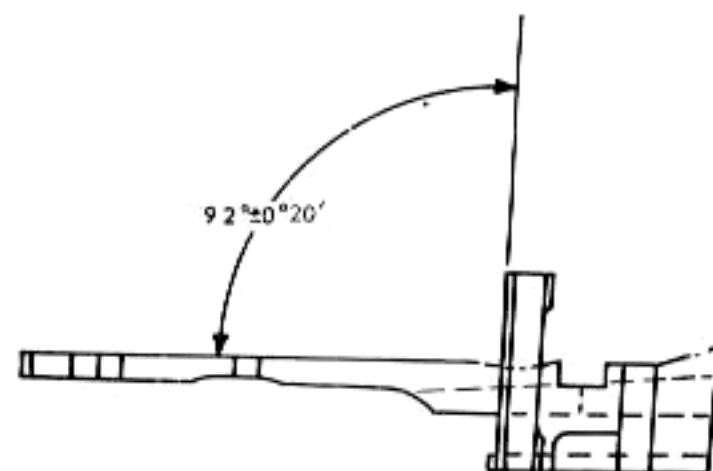

Fig. 123. Follower showing correct angle.

on the top of the threads is removed. Remove all chips after reaming; any chips remaining will cause galling between the gas cylinder and the gas cylinder lock screw, due to the nature of stainless steel, from which the gas cylinder is manufactured. Insert the gage after reaming and if the cylinder is serviceable the index surface of the gage should be level with, or protrude above, the end of the gas cylinder (see Fig. 126). CAUTION: no force must be applied to a gage when a cylinder is being gaged. If the gage is forced into the cylinder and rotated it will act as a reamer, and render the gas cylinder unserviceable. Insert a small rod in the screwdriver end of the gas cylinder lock screw and raise the valve from its seat. Inspect for burrs and foreign matter. This is an important check, as gas allowed to escape through the valve will dissipate the force necessary to drive the operating rod to the rear, thus causing a short recoil malfunction. Inspect function of the valve spring to see that it closes tightly in its seat. Replace all gas cylinder lock screws which have burrs on the valve face or seat, or where the spring tension is

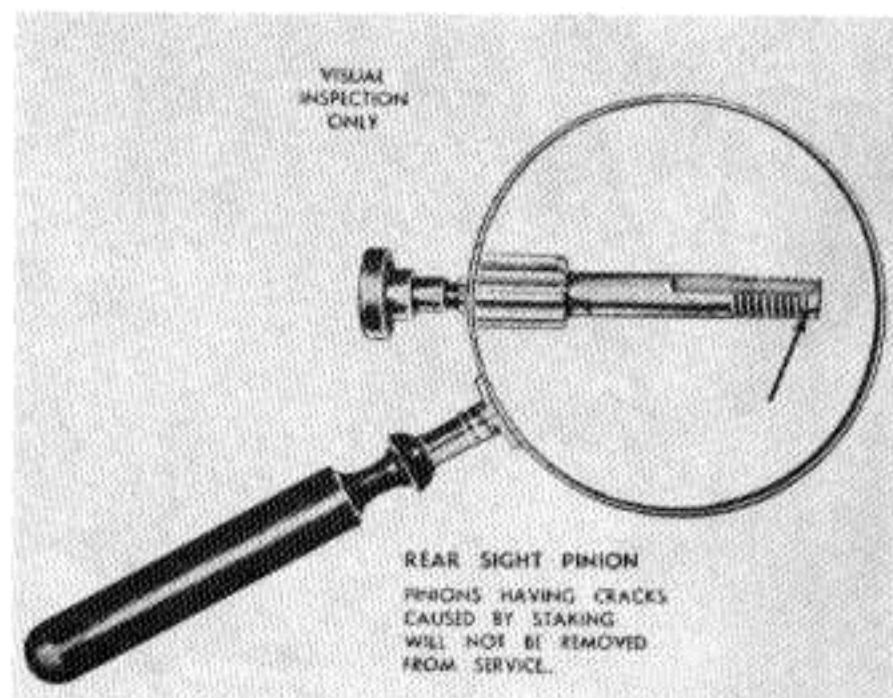

Fig. 124. Rear sight pinion - early manufacture.

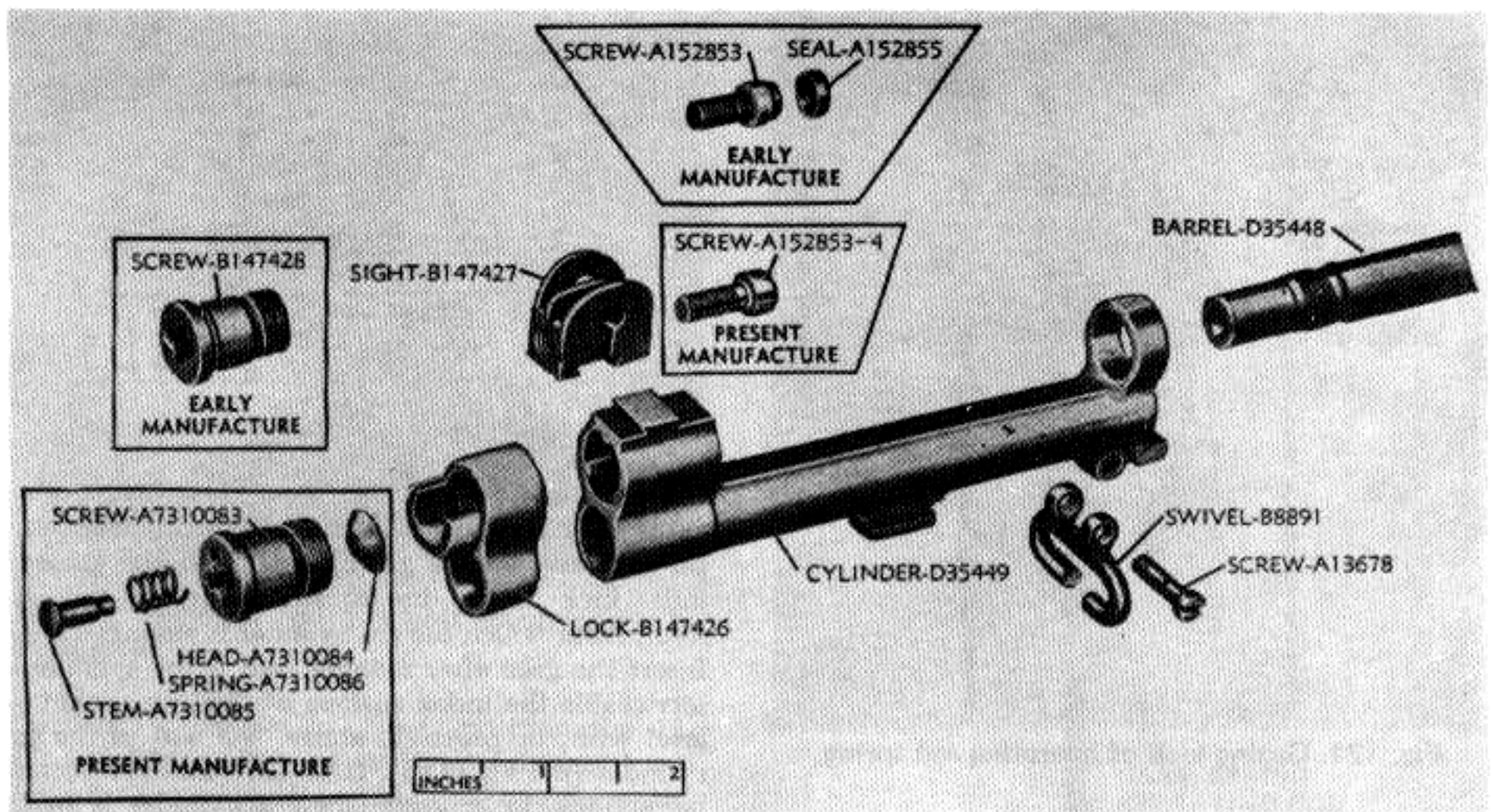

Fig. 125. Front sight and gas cylinder group parts.

insufficient to seat the valve tightly. All gas cylinder lockscrews of early manufacture (sans valve assembly) should be replaced by gas cylinder lock screws with valve assembly. The M5-1 bayonet will not fit on the early type of gas cylinder lock screws, nor will the grenade launchers.

52. Bolt assembly: (Fig. 127)

(a) Bolt: test the bolt in the receiver for

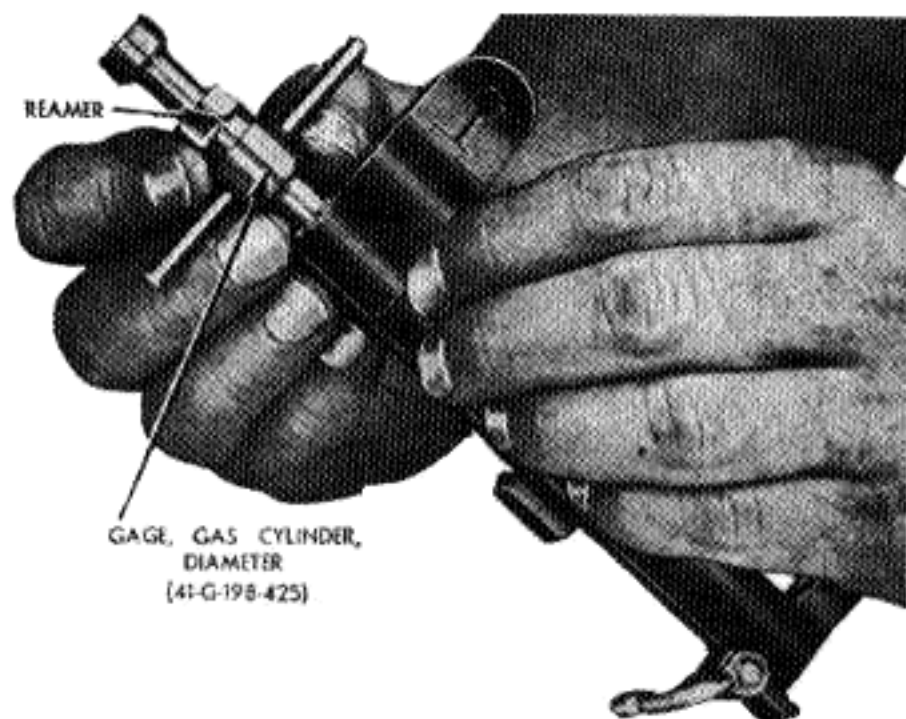

Fig. 126. Gaging bore of gas cylinder at port.

freedom of movement and smoothness, and for locking.

(b) Firing pin: check protrusion of the firing pin beyond the face of the bolt, using the firing pin protrusion gage (Fig. 128). In the fired position, the nose of the pin should protrude from .044 inch minimum to .059 inch maximum. If the firing pin is of the old, full-round type, replace with the new type.

(c) Extractor: test for grip on the cartridge base, and the extractor spring for tension.

53. Barrel: inspect the barrel as outlined in Para. 31.

54. Telescope mount, M1C only: (Fig. 129, 130) inspect the scope mount bracket for retention on the receiver and for burrs on male dovetail slides. Inspect slide for function in scope mount bracket, and locking action of slide clamp with locking screws. Check supports for looseness in slide. Inspect screws and screw holes for worn or stripped threads and all recesses for foreign matter.

55. Telescope mount, M1D only: (Fig. 131) inspect base for looseness on barrel, and for burrs. Inspect dowel pin for burrs, wear, and for looseness in base. Inspect knob for looseness on screw and

THE FIGHTING GARAND

for worn knurling. Inspect function of plunger and spring with knob. Check bracket and hinge for clamping action with telescope. Inspect all screws and holes for stripped threads.

Section 3, Maintenance and Repair

56. Correcting angle on follower: if the angle is not within the required limits (Fig. 123), bend slides to correct angle by lightly tapping with a brass hammer.

57. Operating rod:

(a) The operating rod tube is slightly offset to provide clearance at the enlarged portion of the barrel. This offset should not be changed. When the operating rod is assembled to the rifle by the manufacturer, the operating rod is fitted to its respective rifle by bending. For this reason, operating rods should not be exchanged among rifles if it can be avoided.

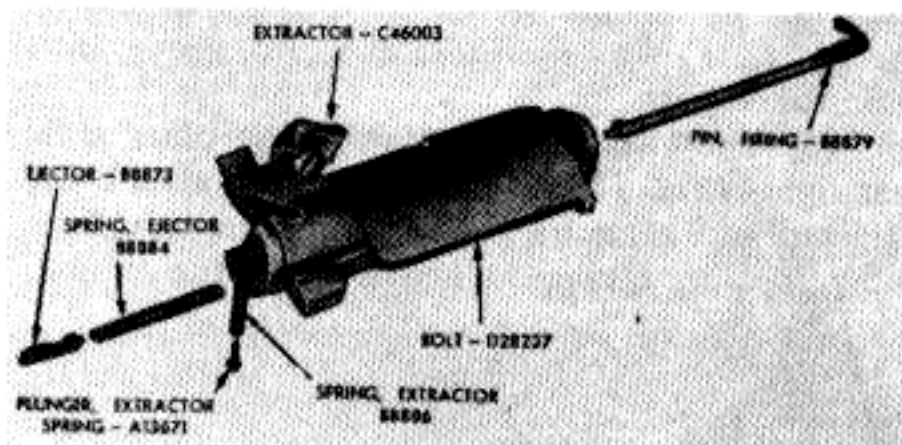

Fig. 127. Bolt assembly, disassembled.

(b) Remove all rust and accumulated carbon from the tube with a fine abrasive or rifle bore cleaner. CAUTION: exercise special care to prevent rounding the edges or reducing the diameter of the piston. Do not use emery or other abrasives on this component, as no shine or polish is necessary.

58. Gas cylinder:

(a) To remove accumulated deposits of carbon from the gas cylinder, remove the lock screw and remove the carbon by scraping with a screw driver or similar tool. The gas cylinder lock may be removed and the screw inserted in the gas cylinder and threaded in far enough to break loose carbon. Exercise care not to cross the threads. The gas cylinder port can be cleaned with a straight punch or the drift on the combination tool. The inside of the gas cylinder should be thoroughly wiped clean and oiled. Remove any rust on the

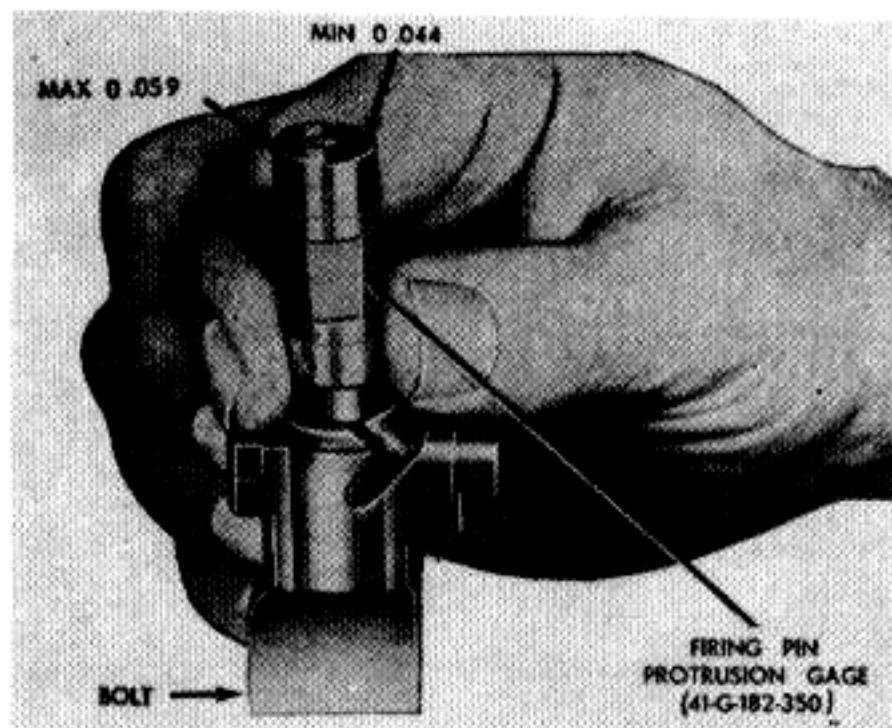

Fig. 128. Gaging protrusion of firing pin.

outside of the cylinder, using rifle bore cleaner or fine abrasive. Remove rust on the barrel at this point in a similar manner.

(b) If the bayonet lug is worn loose-fitting with the ways in the bayonet, the lug may be peened lightly to provide a better fit. Rest the lug on a solid surface when peening.

59. Gas cylinder lock:

(a) Excessive thickness: difficulty may be experienced in fitting the M1 bayonet to the rifle due to excessive thickness or lack of concentricity of the gas cylinder lock. This is rectified by lightly grinding or filing the portion of the gas cylinder lock that fits inside the bayonet guard.

(b) Installation: position the gas cylinder on the barrel. Screw gas cylinder lock down as far as

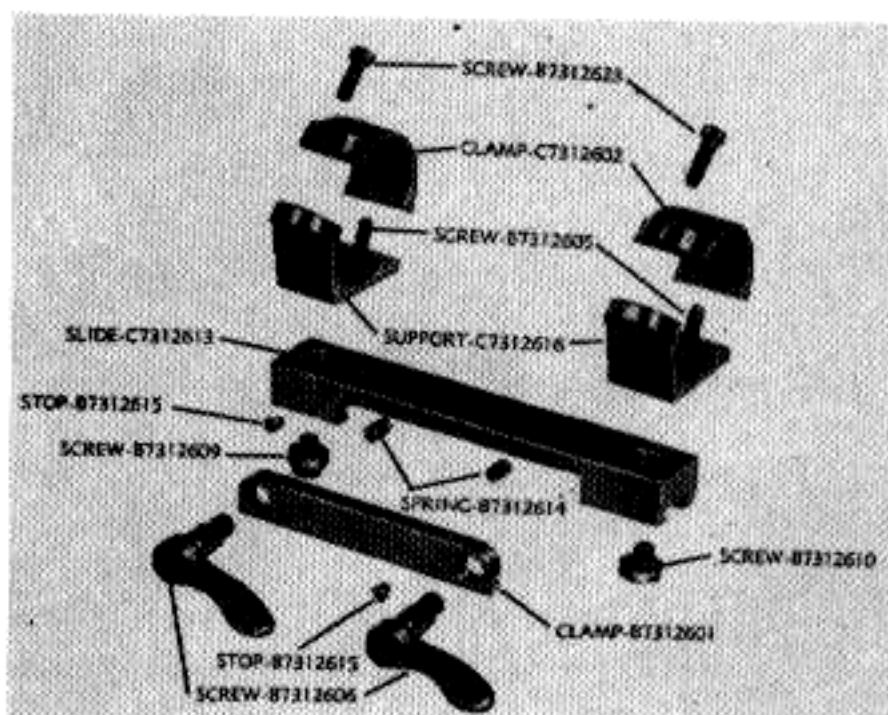

Fig. 129. Scope mount assembly, M1C.

THE FIGHTING GARAND

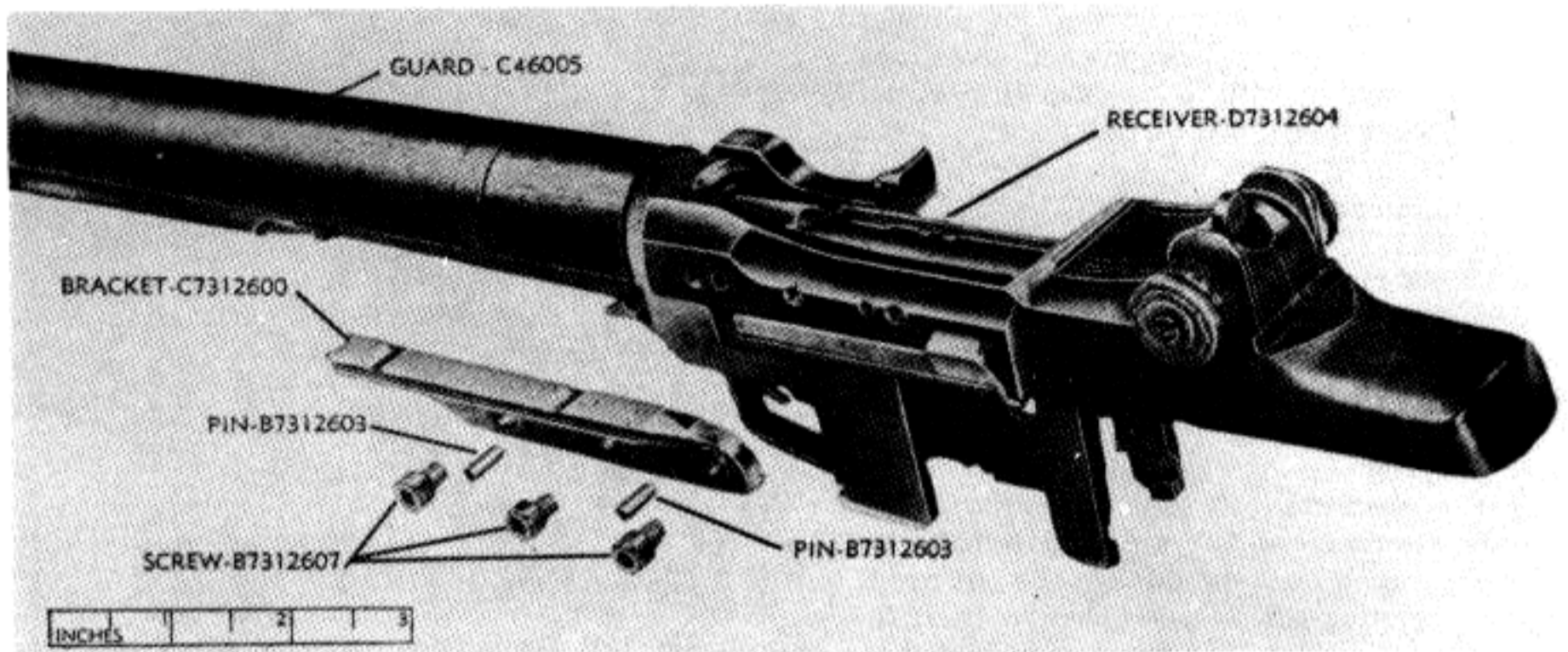

Fig. 130. Receiver and Bracket, M1C.

possible by hand. Do not force. Unscrew the lock until the screw hole in the lock lines up with the threaded end of the gas cylinder, permitting assembly of the gas cylinder lock screw. In some cases the lock will have to be unscrewed almost a full turn. Turn the screw a few turns only, then push the gas cylinder lightly toward the muzzle until it rests against the lock and tighten screw.

60. Rear sights: the rear sights of early and late manufacture (Figs. 132 and 133) differ in construction, as outlined in Para. 24. They should be checked for worn threads, stripped gears, burs and broken parts.

(a) The rear sight pinion on the older style rear sights (Fig. 134) is staked in place after being adjusted and assembled, to prevent the nut from being lost in service. When staking the pinion,

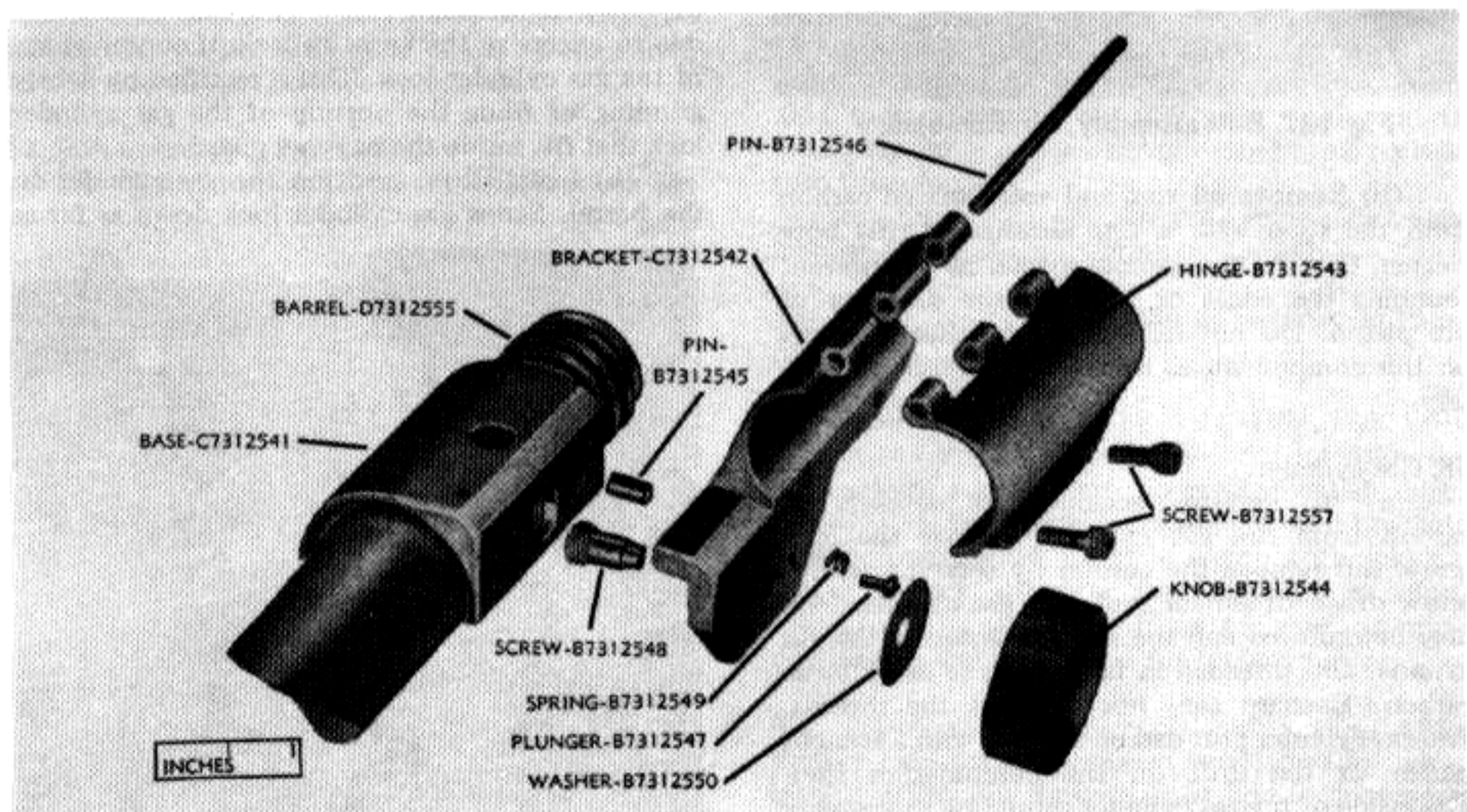

Fig. 131. Barrel with fixed base and scope mount parts, M1D.

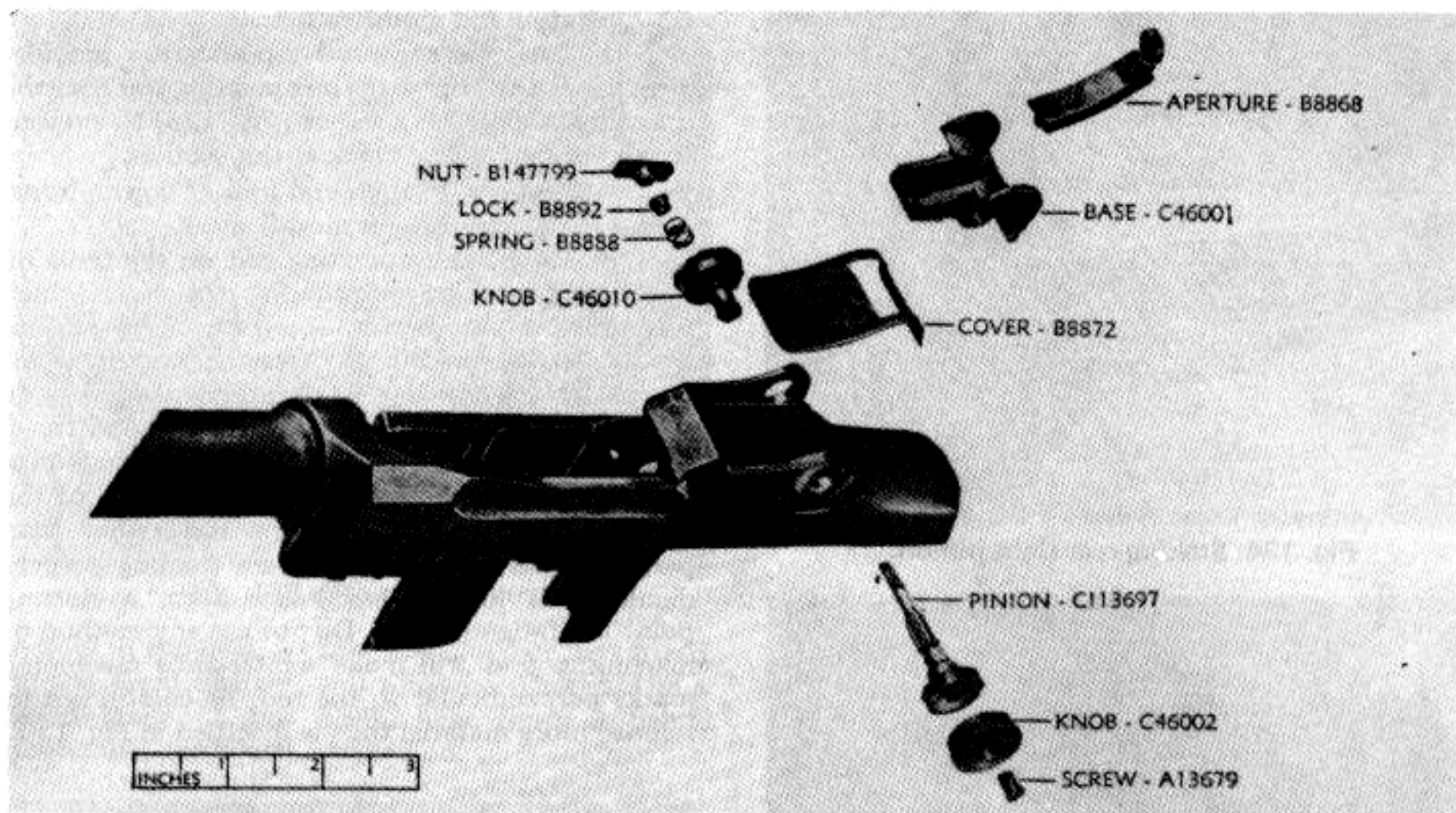

Fig. 132. Rear sight assembly, early manufacture.

a lead bar should be placed under the sight as shown, to prevent damage to the elevating knob.

(b) The rear sights of later manufacture do not require staking.

61. Barrel:

(a) Rust on barrel: rust on the side of the barrel may be removed by rubbing with a cloth and oil or bore cleaner. If this is not sufficient, a crocus cloth may be used, carefully so as not to produce a shine. Make certain there is no rust or foreign matter in the gas port or where the gas cylinder contacts the barrel. The outside of the barrel at this point must not be reduced, since any leakage of gas reduces the power available to operate the weapon, and will produce short-recoil stoppages. Check diameter of the barrel at the gas port after cleaning, using gage (Fig. 135).

(b) Carbon at gas port: the gas port in the barrel should not be enlarged. Carbon, corrosion or fouling may be reamed out by passing a .0805 drill through the port. Note: the size of the gas port should not be enlarged! If the gas port is increased in size to make one rifle function, and at a later date another gas cylinder is installed, the power of the rifle will be increased, which will increase the speed of the bolt to such an

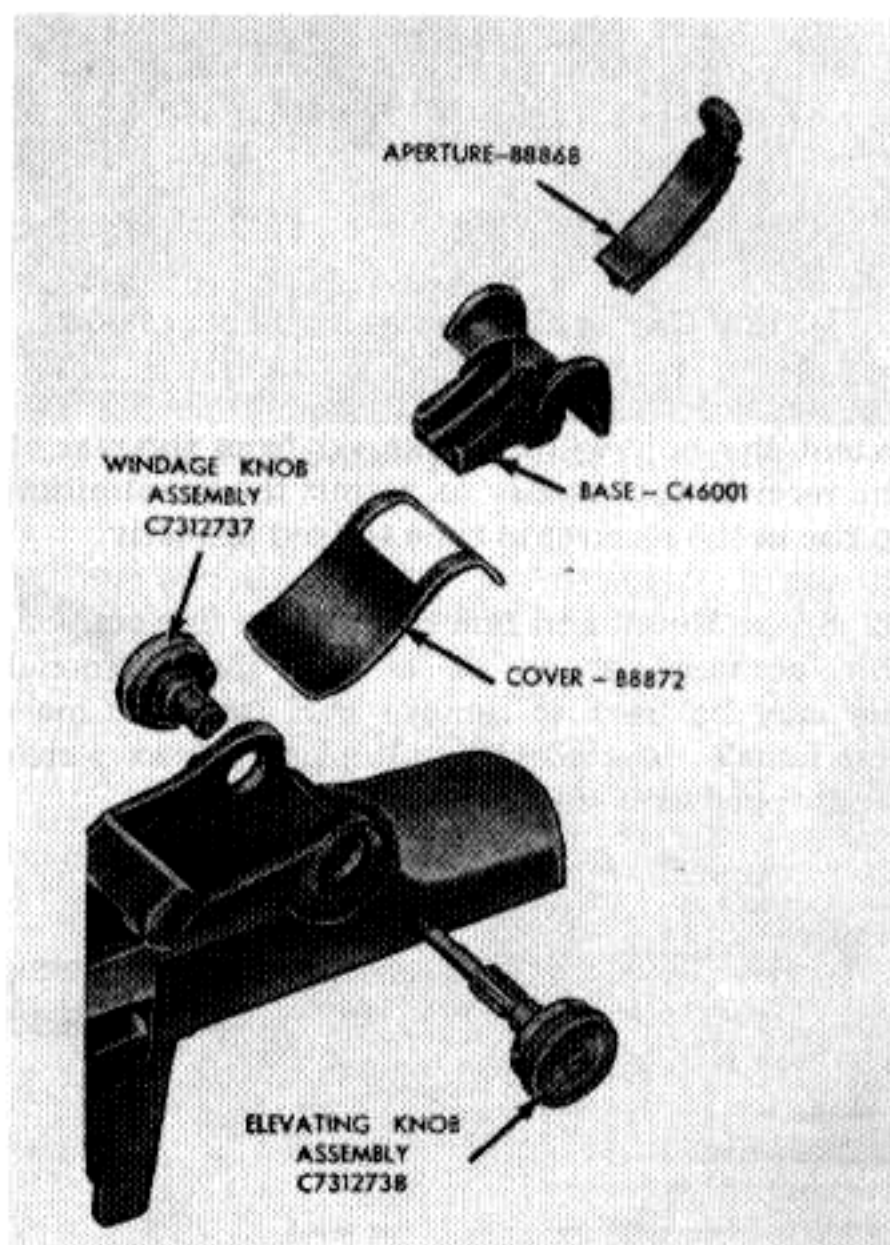

Fig. 133. Rear sight assembly, late manufacture.

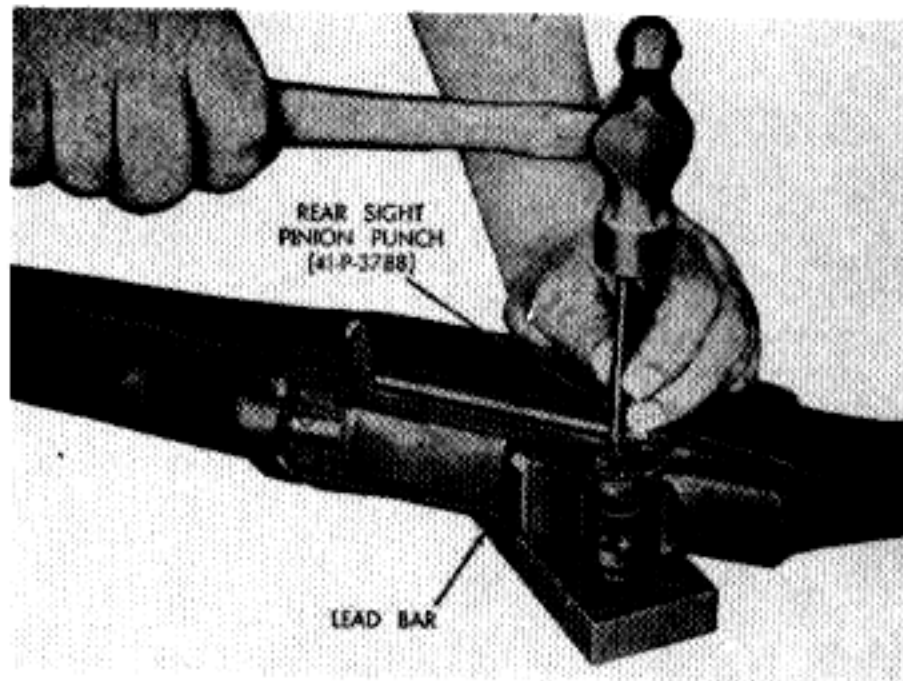

Fig. 134. Staking rear sight pinion.

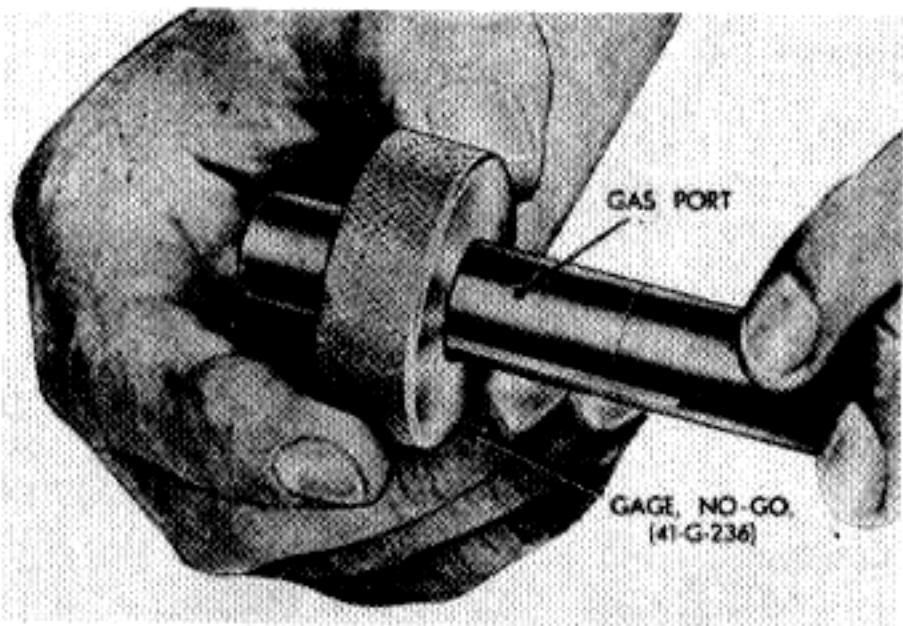

Fig. 135. Gaging diameter of barrel at gas port.

extent the bolt will be bounced from the rear of the receiver too rapidly to permit the ammunition to rise in the receiver in time to feed properly.

62. Scope Mount and Bracket, M1C: a fine grained, three-cornered stone or a fine three-cornered file may be used to remove burrs from the male and female dovetail slides. Replace screws which are stripped or worn to a loose fit.

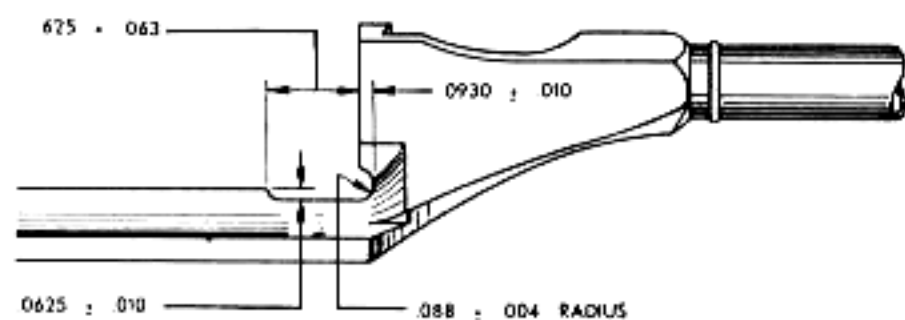

Fig. 136. Operating rod modification.

63. Operating rod modification:

(a) The operating rod modification provides a radius at the corner in the operating rod near the operating rod catch notches (Fig. 136) to prevent the development of a crack at this section.

(b) Use a 3/16 inch end mill of conventional design in performing this modification.

(c) Mount the operating rod on the table of the milling machine with the flat section, on which the drawing number is stamped, perpendicular to the axis of the cutter. Ascertain starting point of cut with scribe line on improvised depth gage (Fig. 11). Start the cut at the rear end and travel forward on rod until the specified radius is produced. Note: it is essential that the marks of the cutter be lengthwise with the rod rather than perpendicular to it, as any mark running perpendicular will localize stress and form a starting point for fatigue cracks. Do not use any method of machining that will make scratches or machining marks perpendicular to the rod. Be careful not to remove more material than is specified in Fig. 136.

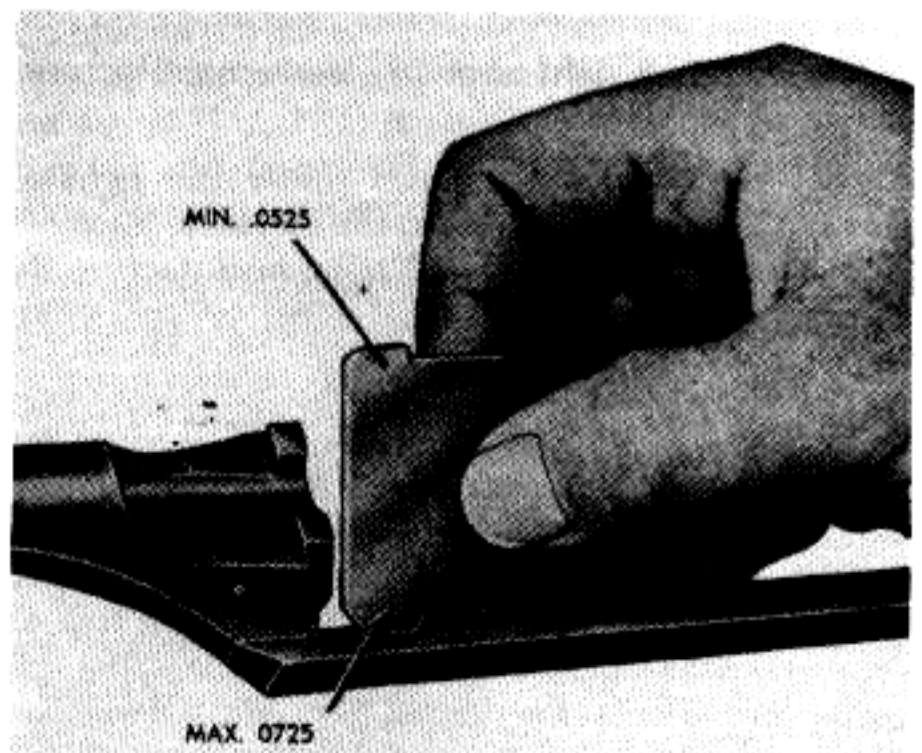

Fig. 137. Gaging cut with depth gage.

(d) Use the improvised height and depth gages (Figs. 109 and 110) to check cut. The gage shown in Fig. 137 is a maximum-minimum gage to check depth of cut in the handle section of the operating rod. With gage on position on rod, origin of the cut should fall within width of solid line scribed on gage.

64. Refinishing shiny gas cylinders: the gas cylinders, gas cylinder locks and gas cylinder lock screws are made from stainless steel. Due to the

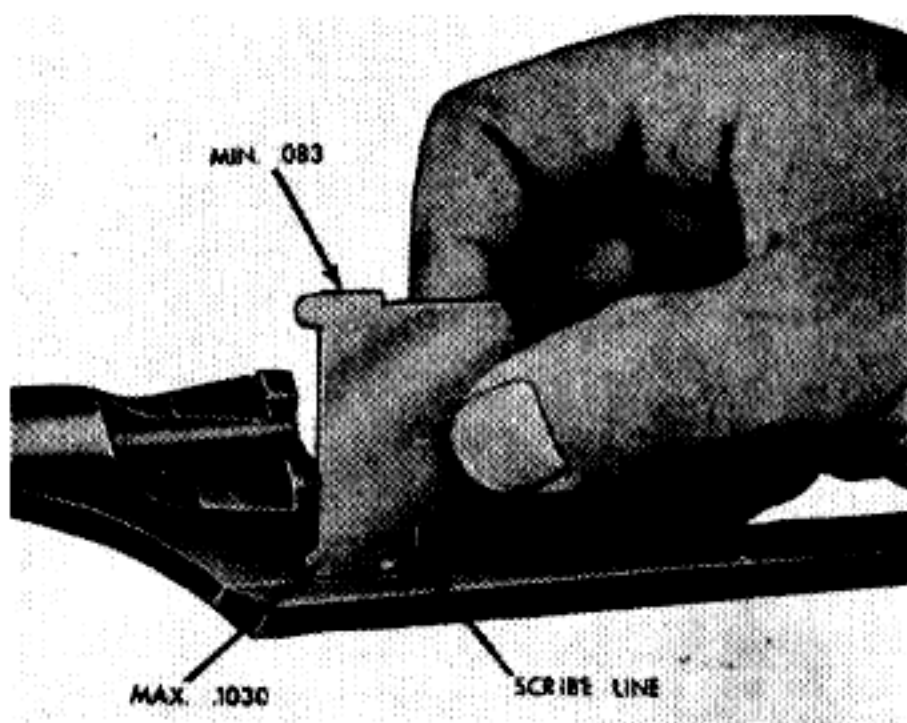

Fig. 138. Gaging fillet cut.

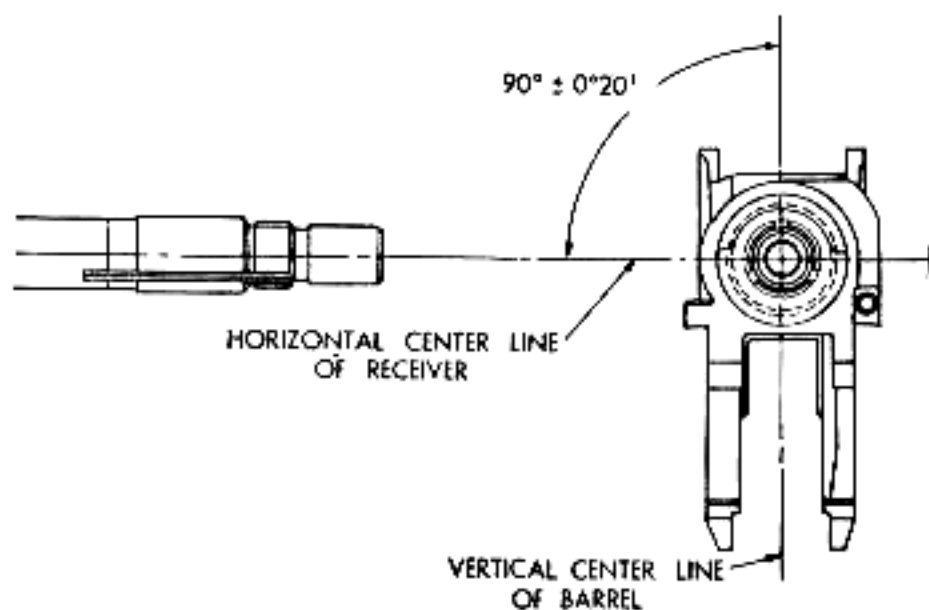

Fig. 140. Barrel and receiver assembly.

nature of stainless, it cannot be blued or parkerized in the usual manner, and must be painted. Use a good grade of flat black, heat resistant paint, preferable one which is baked on.

65. Barrel replacement:

(a) Disassembling: remove the unserviceable barrel from the receiver, as outlined in Para. 41.

(b) Assembling: without using undue force, screw the barrel on the receiver by hand until it fits tightly. The receiver should be approximately 15 degrees out of its correct position on the barrel, to insure a tight fit when the final draw is made in the barrel and receiver assembling fixture. Clamp the group in the barrel and receiver assembling fixture with three clamps, tightening the lower clamp first to level the receiver (Fig. 139). Slide the key, located on the indicating arm of the fixture, into the upper gas cylinder spline cut as

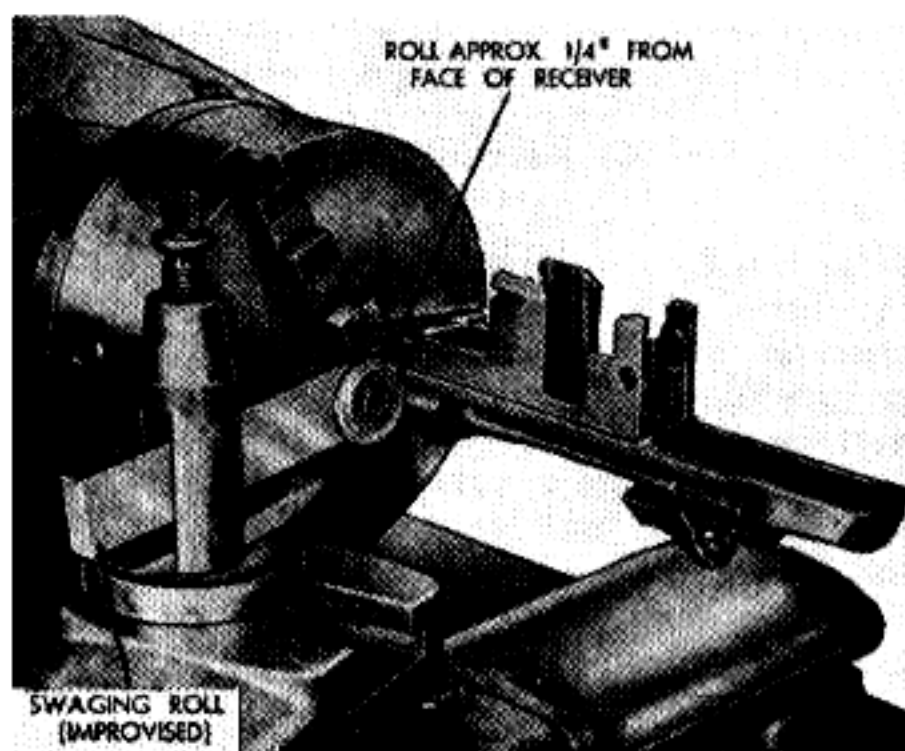

Fig. 141. Swaging barrel to fit tightly.

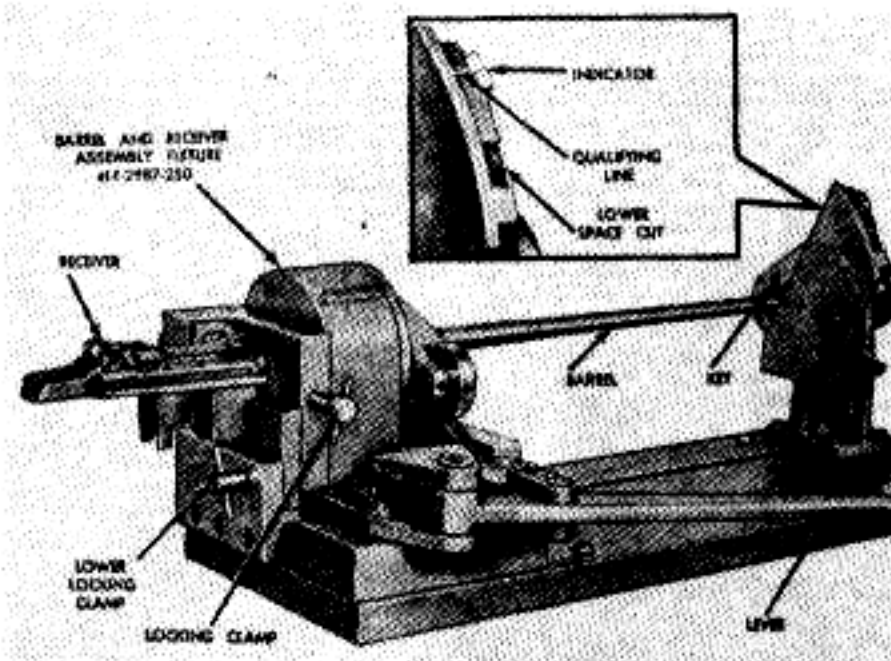

Fig. 139. Assembling barrel and receiver.

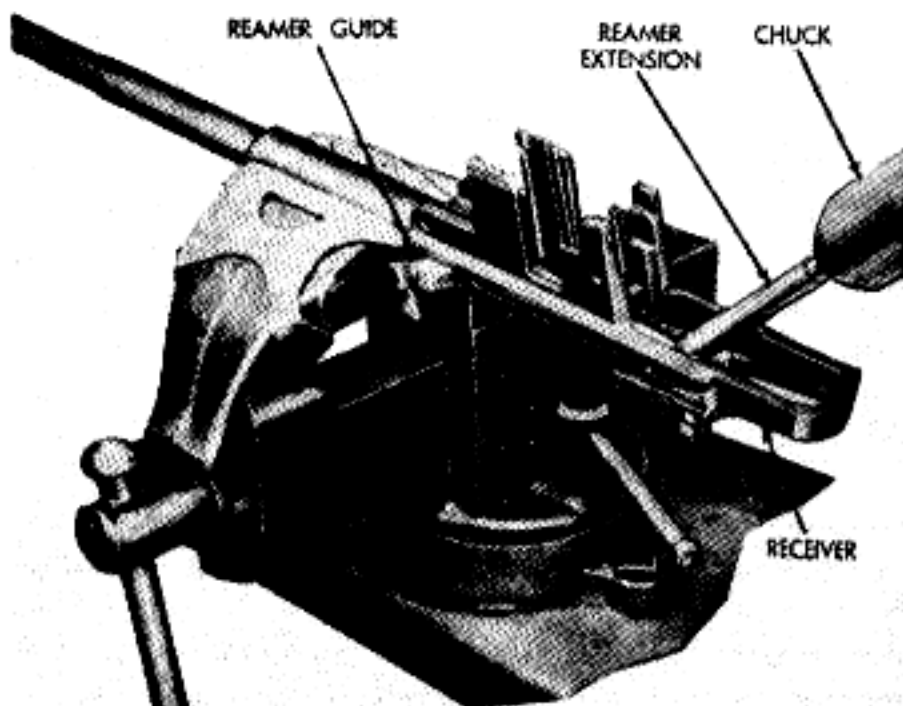

Fig. 142. Reaming headspace.

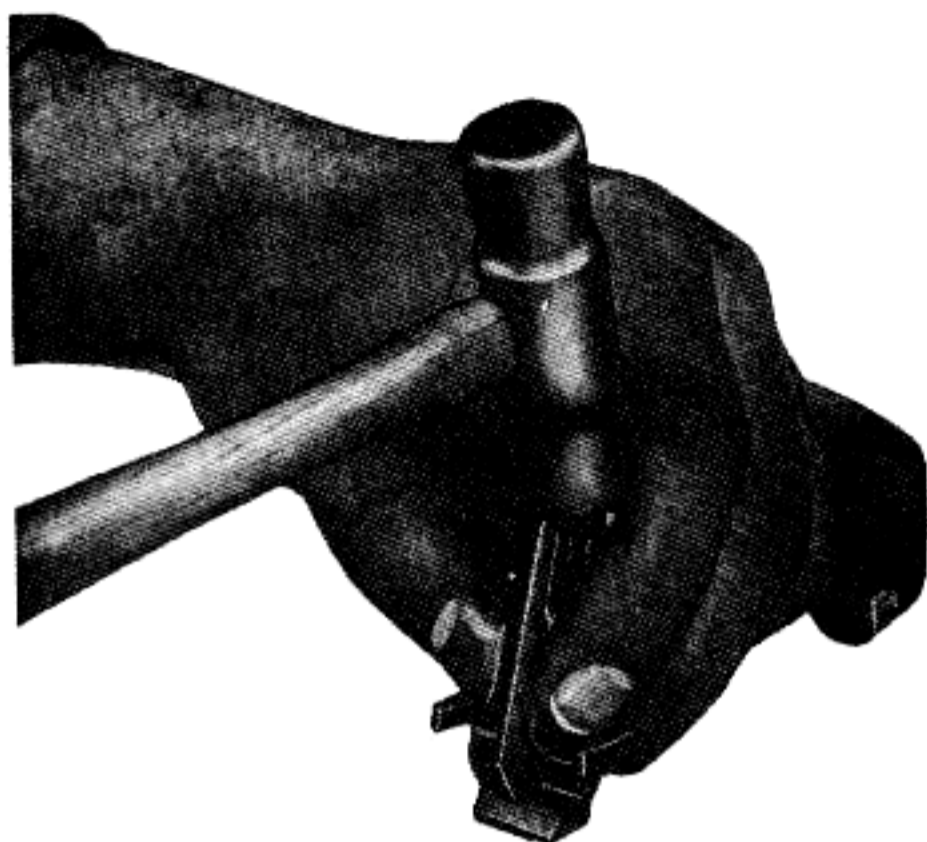

Fig. 143. Assembling follower.

far as it will go. Pull on the lever, thereby turning the barrel the required distance to bring the indicator to agreement with the qualifying line on the fixture. (Note: pointer must travel the distance from within lower space cut to qualifying line cut to insure a tight fit.) Then loosen the locking clamps and remove the assembly from the fixture, using a bar placed through the trigger housing opening in the receiver as a lever to start the assembly from the fixture.

(c) Looseness of barrel in receiver: if the barrel screws into the receiver by hand to within 7 degrees of its assembled position, it is considered to have "light draw". This may be corrected by placing the barrel and receiver in assembling fixture and assembling properly, then chucking the barrel in a lathe, with the receiver being as close to the chuck as possible, allowing room for the swaging roll (Fig. 141). With the roller in the tool post, roll the barrel. The edge of the roller should be 1/4 inch away from the receiver. Do not loosen the barrel after rolling, as re-rolling will be necessary.

66. Reaming Headspace:

(a) Wipe the chamber thoroughly with a cotton flannel before and after each reaming, and prior to each headspace check during reaming. Screw the short adapter (Fig. 142) deeply into the reamer and tighten the lock nut. Dip the reamer in lard oil and insert it into the reamer guide. Make certain the bolt lug recesses in the

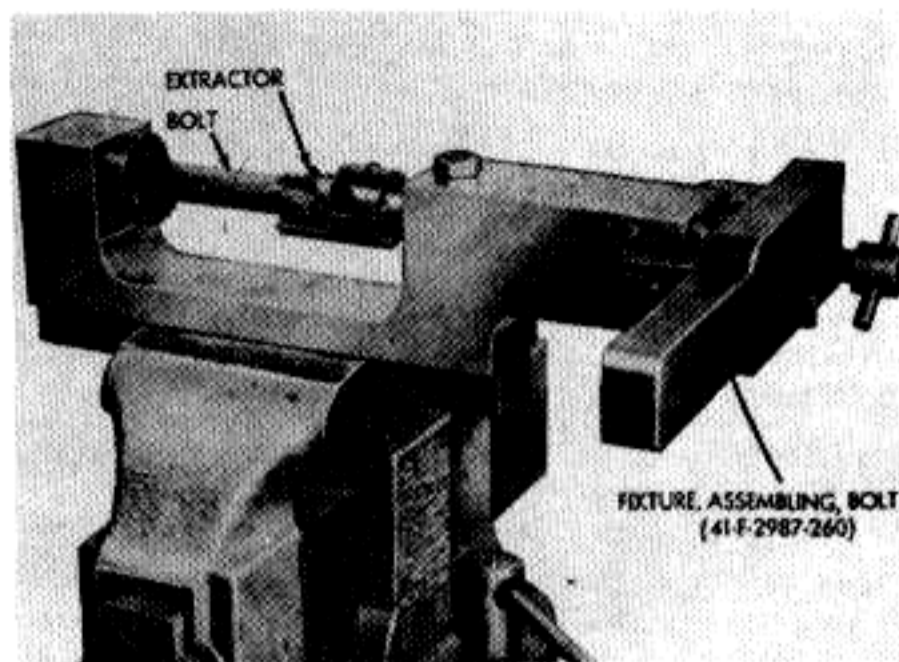

Fig. 144. Installing extractor in bolt.

receiver, and tighten thumb screw to hold guide in position.

(b) Attach the universal-jointed extension to the reamer and rotate it with a chuck. Unscrew the adapter from the reamer a little at a time until the reamer begins to cut. (Note: if the reamer has been correctly assembled to the adapter it will not cut, but will be held away from the chamber by interference between a shoulder in the guide and the adapter.) Adjusting of the headspace reamer is accomplished by loosening the nuts and backing off or advancing the adjusting screw a little at a time, using the field test bolt and headspace gage to check for proper adjustment.

(c) When the adapter is correctly adjusted in the reamer, check the tightness of the locking nut. The reamer, once it is adjusted, and if carefully used, will continue to ream the same dimension until the reamer becomes dull and must be replaced or sharpened. Never turn the reamer backward, as such action will chip the lands.

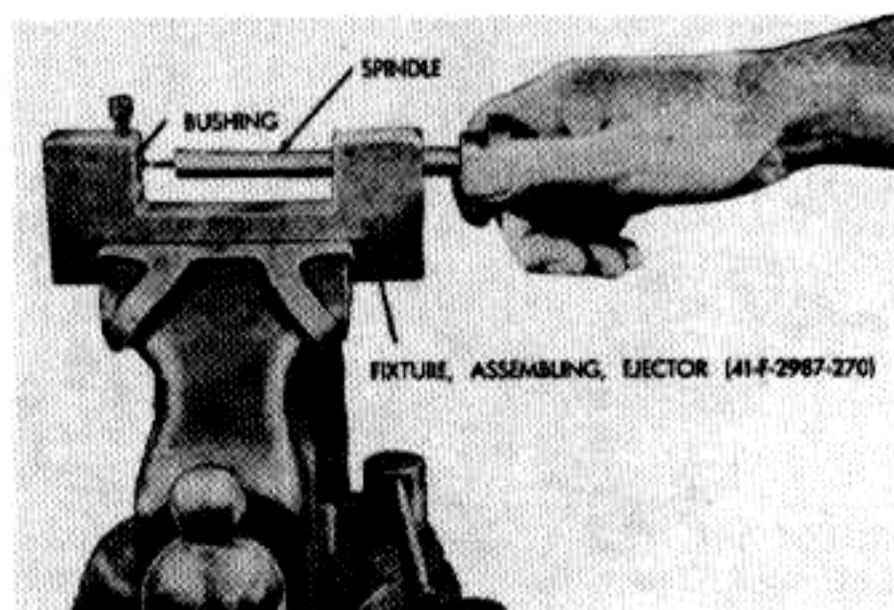

Fig. 145. Assembling ejector and spring.

THE FIGHTING GARAND

(d) Use liberal quantities of lard oil when reaming and wash all chips from the reamer with lard oil each time it is removed from the work. Sharpening stones of suitable dimensions may be used to hone the reamers.

Section 4, Assembly

67. General assembly of the components of the barrel and receiver group is accomplished as outlined in Part 1. Certain parts which are not ordinarily disassembled, and others which are best assembled with the aid of fixtures when rebuilding a substantial quantity of rifles, are covered below:

(a) Follower and slide assembly: to assemble, hook the slide in place in the small end of the follower. Stand the two pieces on end (Fig. 143) or mount them at an angle in a vise. With a soft hammer deliver a sharp blow on the rear end of the slide. It will then snap back into position on the follower.

(b) Bolt assembly, using assembling fixture: the use of the bolt assembly fixture is the easiest method of installing the extractor (Fig. 144) when a large number of bolts are being repaired. Install firing pin, extractor spring, and extractor plunger, also ejector spring and ejector in bolt and clamp bolt in fixture. Start extractor in bolt and tap in place with a soft hammer. This fixture can also be used to remove the extractor.

(c) Assembling ejector, extractor, and rear sight springs: when rebuilding large quantities of rifles, the ejector assembling tool is a handy instrument for assembling the ejector, extractor and rear sight springs to their respective components. To use, select the proper spindle and bushing corresponding to the components being assembled. Place the spring in the aperture in the spindle and its related component in the bushing (Fig. 145). Press forward on the knob until component is inserted in spring.



IX. Trigger Housing Group

Section 1, Disassembly

68. Disassemble as outlined in Para. 24.

Section 2, Inspection

69. General: inspect all parts for damage, wear, burs, rust, foreign matter in recesses, deformation, and free action with mating parts. Additional inspection procedure is outlined below:

70. Hammer: check the nose of the hammer for wear or slipping (Fig. 147). Chips indicate excessive hardness and warrant replacement of the hammer. Check sear and trigger notches for wear.

71. Safety: the safety is subjected to little wear and therefore fails mainly as a result of breakage. Breaks usually occur at the points indicated in Fig. 148. Either the type of early manufacture or the slightly modified later manufacture safety is satisfactory for use.

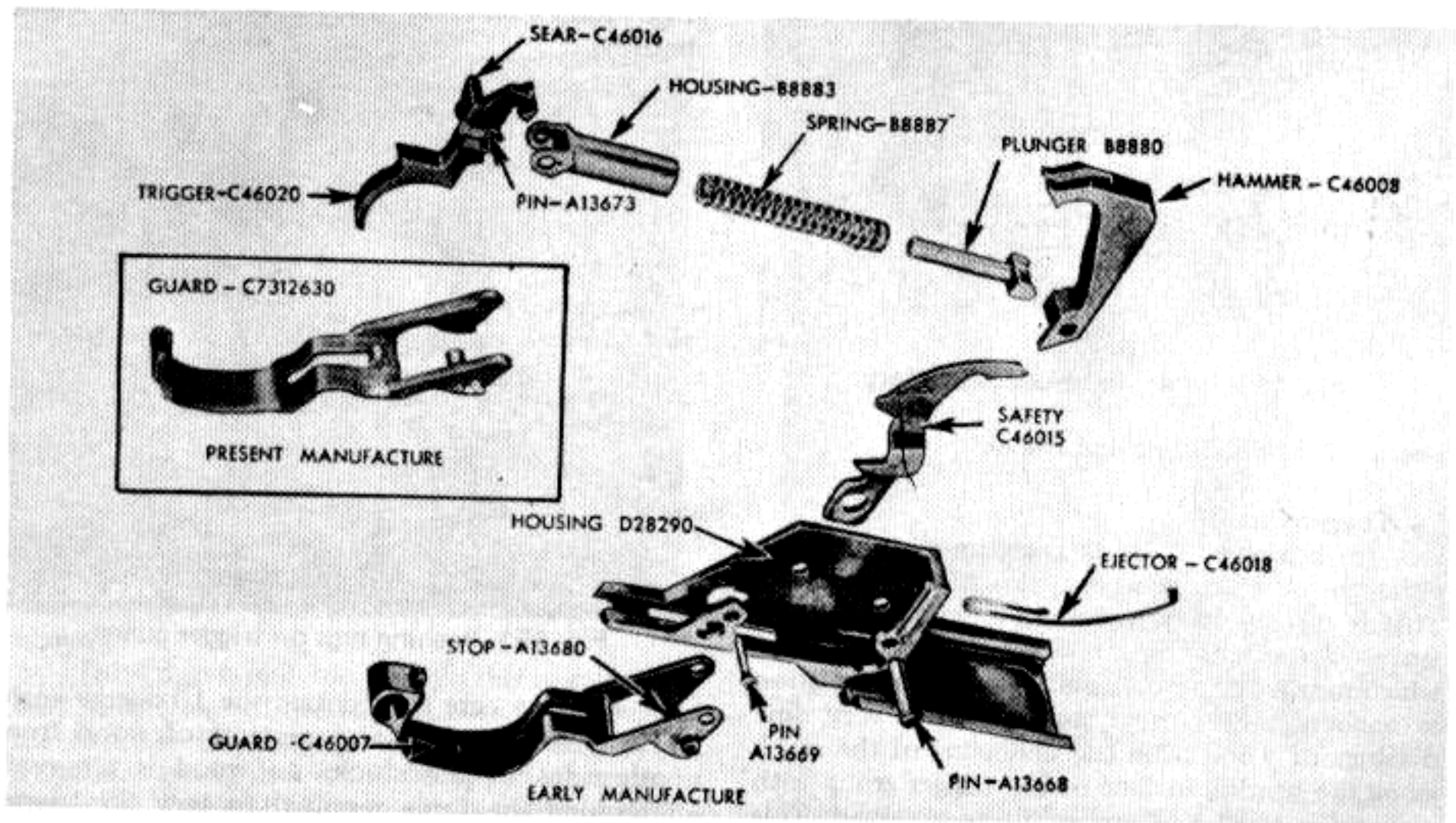

Fig. 146. Trigger housing group parts.

THE FIGHTING GARAND

72. Trigger assembly: inspect the trigger assembly for wear on hammer-engaging notches as indicated in Fig. 149. Also check for broken edge in front of the hole, as indicated.

73. Hammer spring housing: the hammer spring housing usually fails as a result of breakage. Inspect for cracks at the point indicated in Fig. 150. This is a visual inspection only.

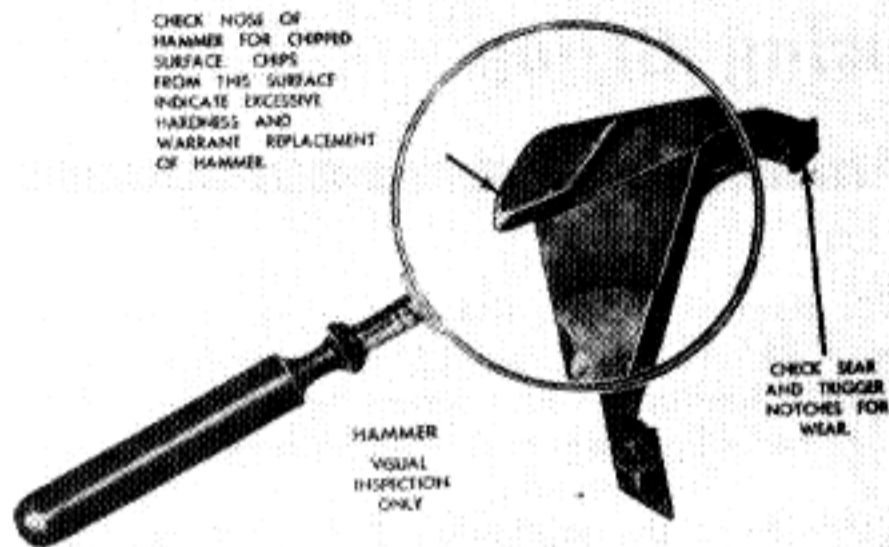

Fig. 147. Points to inspect on hammer.

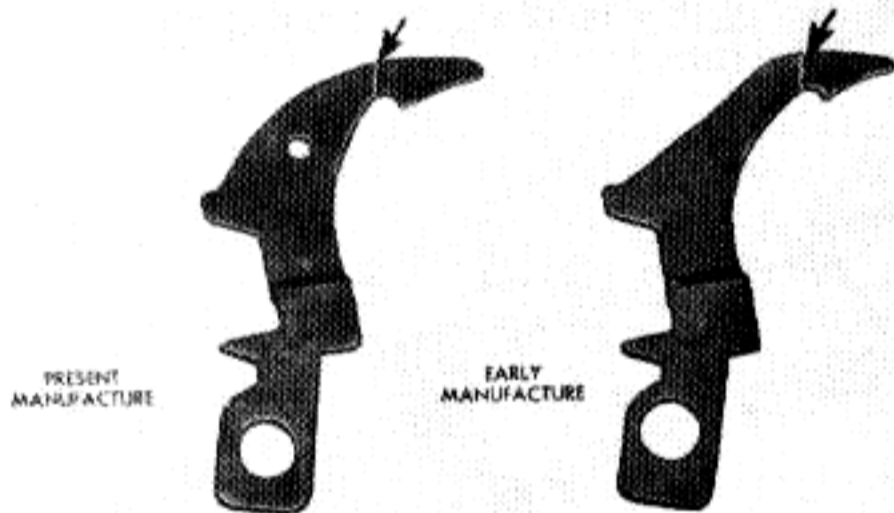

Fig. 148. Points to inspect on safety.

Section 3, Maintenance and Repair

74. Trigger Guard:

(a) Excessive force is sometimes required to close the trigger guard on the rifle (Fig. 146). This is usually true where the climate is humid, and is a result of the increased moisture content which makes the wood swell. When this condition is encountered, correct by removing very fine shavings of wood from the underside of the stock along the bearing surface of the trigger group with a fine file until the proper fit is obtained. This surface is at a 10 degree angle to the horizontal.

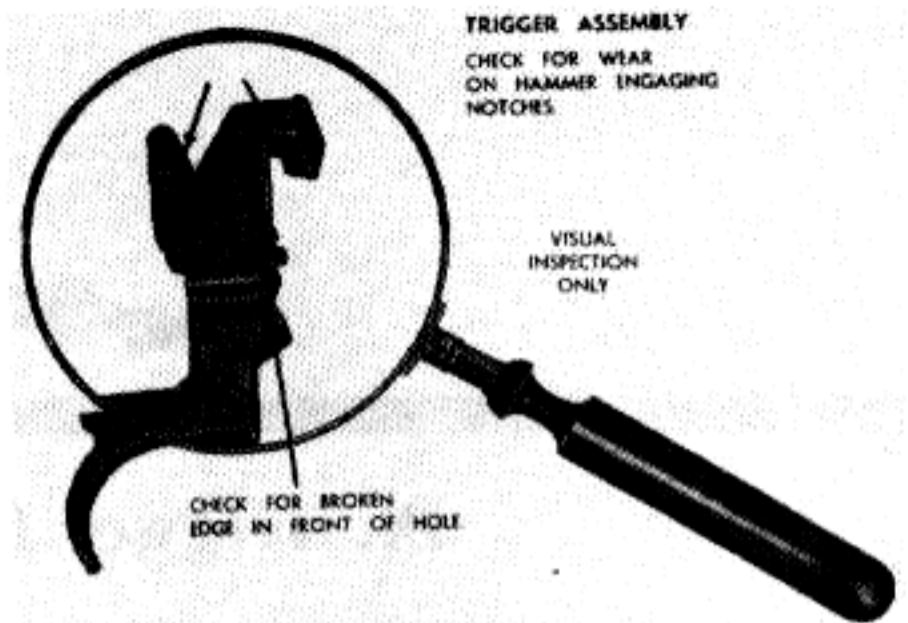

Fig. 149. Points to inspect on trigger assembly.

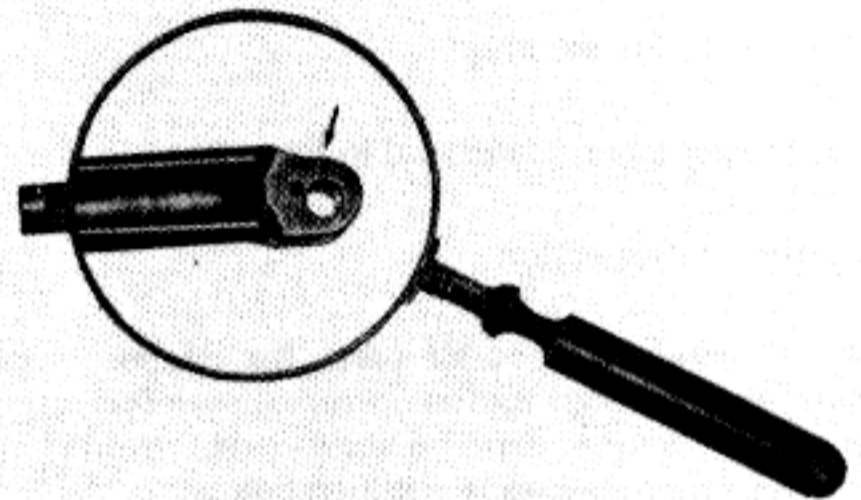

Fig. 150. Points to inspect on hammer spring housing.

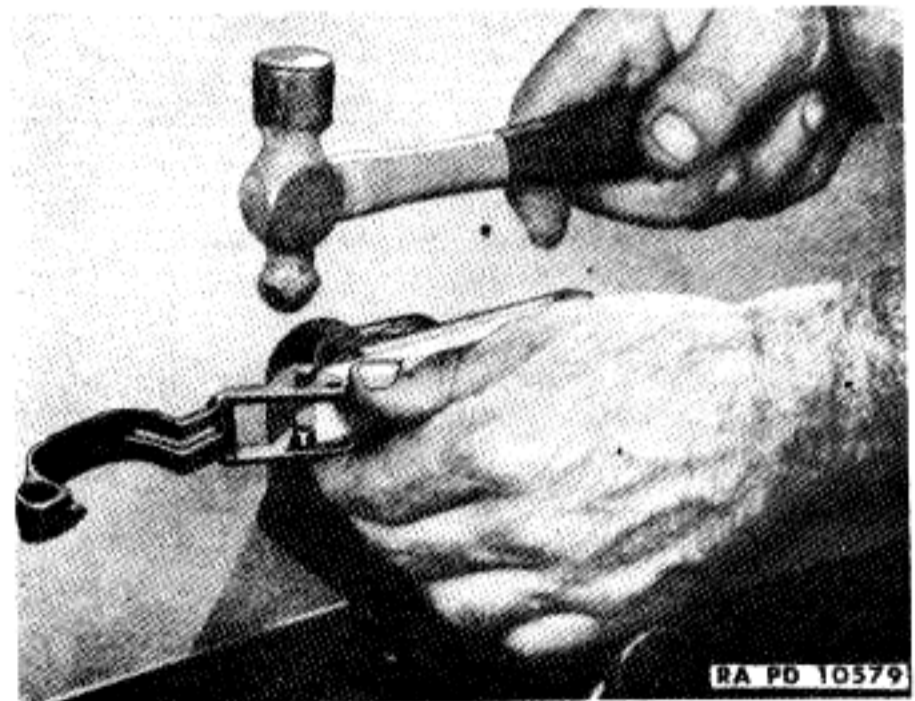

Fig. 151. Peening lugs on trigger guard.

Use extreme care to maintain the 10 degree angle and to remove the same amount of wood from both sides of the stock. As wood is removed, determine the force required to lock the trigger guard by frequent reassembly. The normal force

THE FIGHTING GARAND

required to close the trigger guard is reasonable, but not excessive. The trigger guard must not be loose as this is the only point at which the action is locked in its bedding. Make certain the guard latches properly.

(b) When the bow in the trigger guard is bent up to interfere with the tip of the trigger, it can be straightened, or the tip of the trigger ground off. When the trigger locking lugs become worn, peen lightly as shown in Fig. 151, to resize them and then dress to shape with a fine file. The trigger guard fork may become sprung in, thus causing binding, or sprung out, thus preventing the hammer pin from extending far enough through for proper bearing. Correct these faults by springing the fork back into correct position.

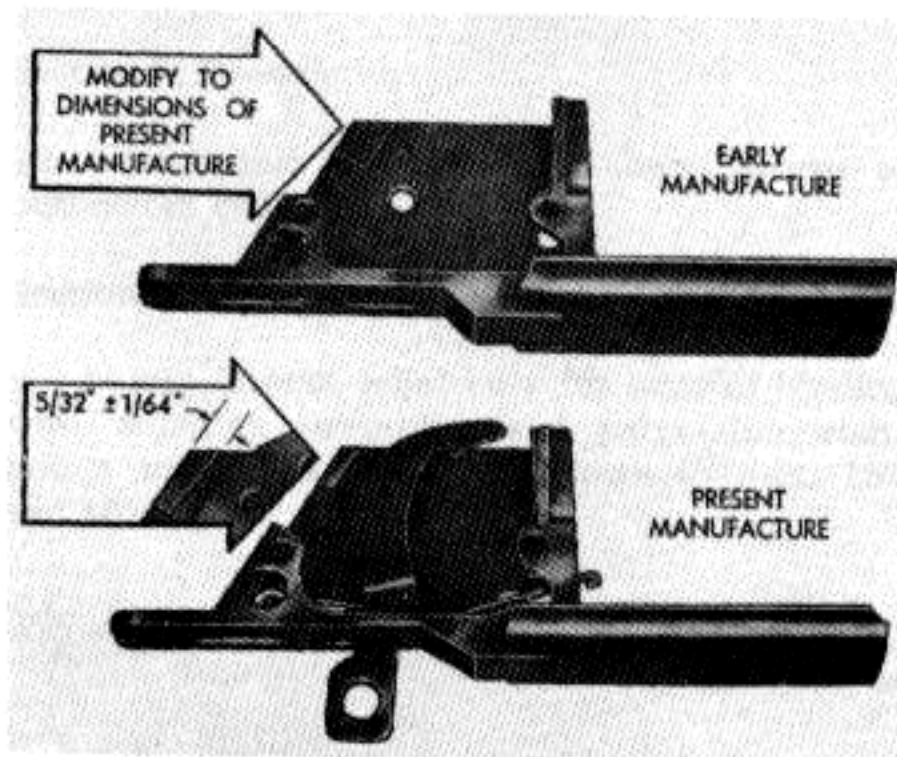

Fig. 152. Modification of trigger housing.

75. Trigger housing: modify the pads on the upper rear corner of the trigger housings of early manufacture to the dimensions of later manufacture, as shown in Fig. 152. This is required to enable assembly of current design safeties.

76. Correcting trigger pull:

(a) Trigger pull too light: this is evidence of worn lugs on the trigger, worn lugs on the hammer, or a weak hammer spring. Examine the components for wear and replace with new components.

(b) Trigger pull too heavy: this is caused by burrs on the lugs of the trigger, burrs on the lugs of the hammer that engage the lugs on the trigger, a hammer spring that is too heavy, an obstruction or foreign material in the hammer spring housing that prevents proper seating of the hammer spring,

or a bent trigger that rubs against the trigger housing. Examine the parts for defects, remove all burrs with a fine stone, and replace defective parts.

(c) "Creep" in the trigger: slightly rough contacting surfaces of the trigger lug may cause "creep" in the trigger, and should be removed with a fine stone. Stone to a polish only, being careful to maintain proper level and angle.

77. Bent Safety: when the safety is bent so that it binds in the trigger guard cut, it is to be replaced. It cannot be straightened because it is hardened steel.

Section 4, Assembly

78. Assemble the trigger housing group as out-

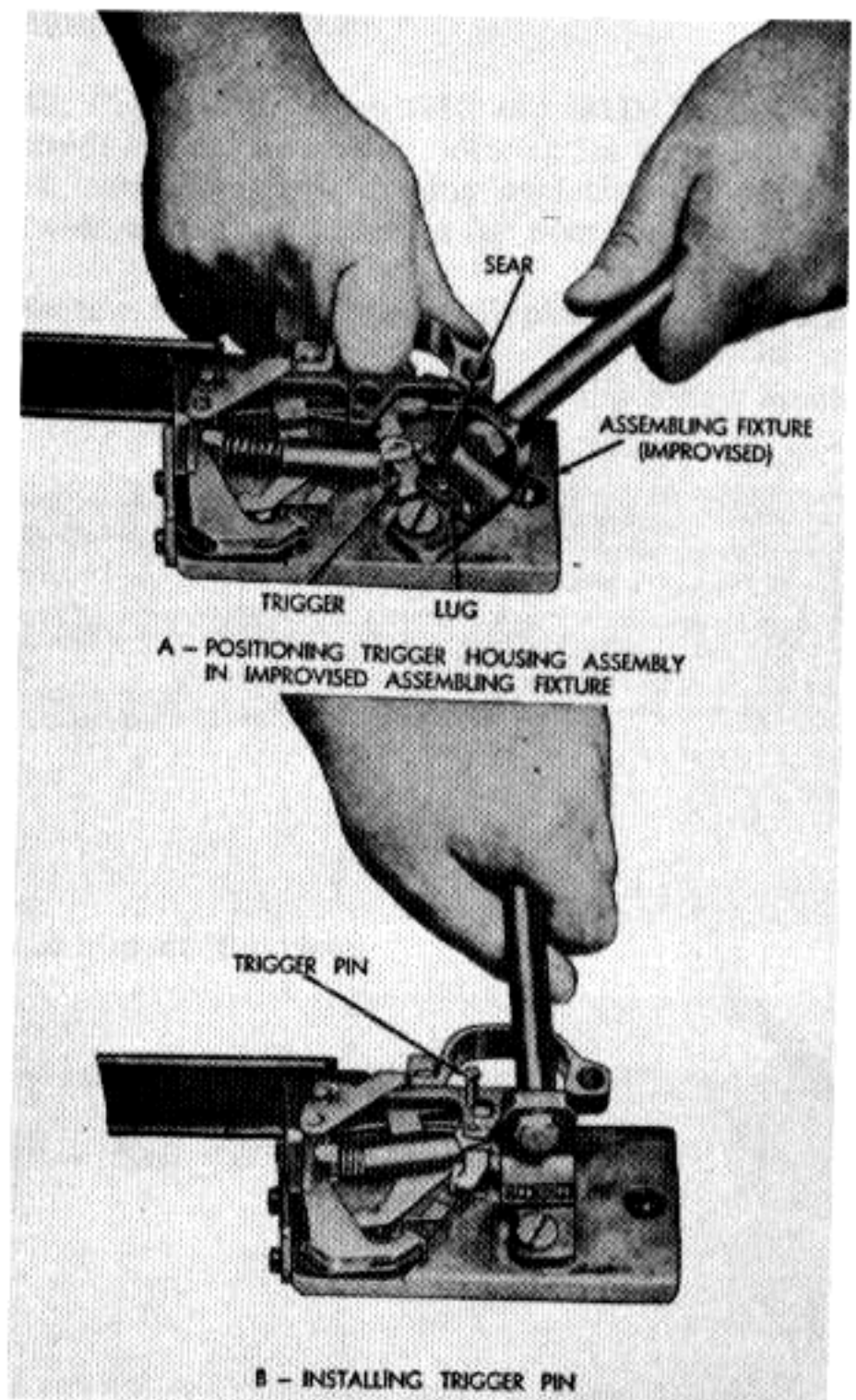

Fig. 153. Installing trigger pin, using fixture.

THE FIGHTING GARAND

lined in Para. 24 (j). When assembling a large quantity of trigger housings, the assembling fixture may be used to speed up the work. To seat the trigger pin head, place the trigger housing, open

side up in the fixture, and engage the lug between the sear and trigger (Fig. 153); compress the hammer spring, align holes, and install trigger pin.



X. Stock And Hand Guards

Section 1, Disassembly

79. Disassemble the stock and hand guards as outlined in Para. 24.

Section 2, Inspection

80. Stock: inspect relief cuts for signs of binding with adjacent assemblies and parts. Important points to be inspected are shown in Figs. 154 and 155.

81. Hand guards: inspect hand guards for defects illustrated in Fig. 156.

82. Cheek pad: (rifles M1C and M1D) inspect the condition of the leather, looking for ripped stitches, cuts, abrasions, missing eyelets and tears between holes. Inspect lacing for wear and tears.

Section 3, Maintenance and Repair

83. Fitting new stock: when fitting a new stock

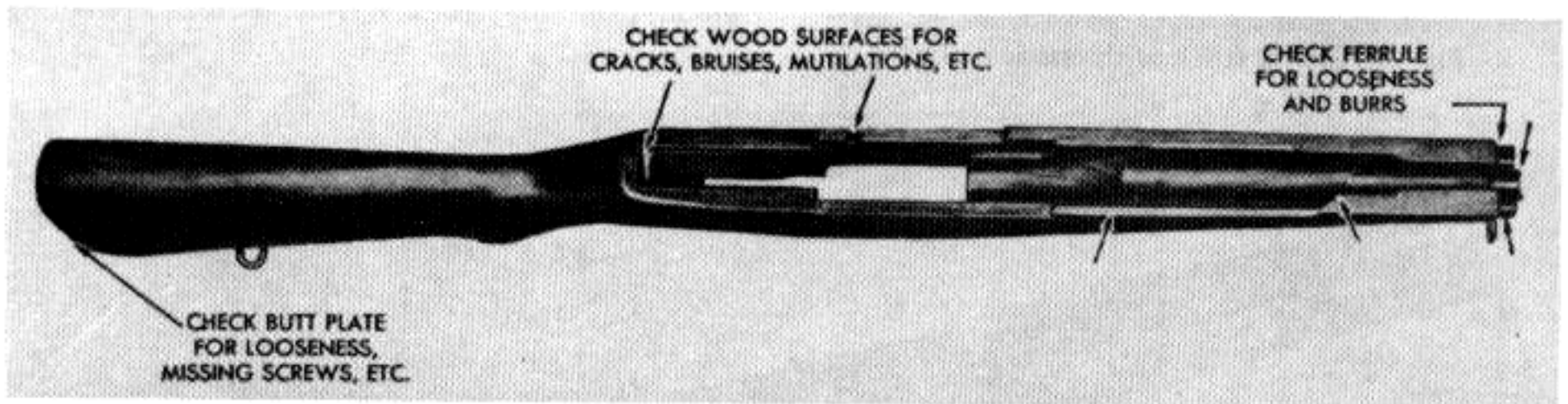

Fig. 154. Stock group, points to inspect (top view).

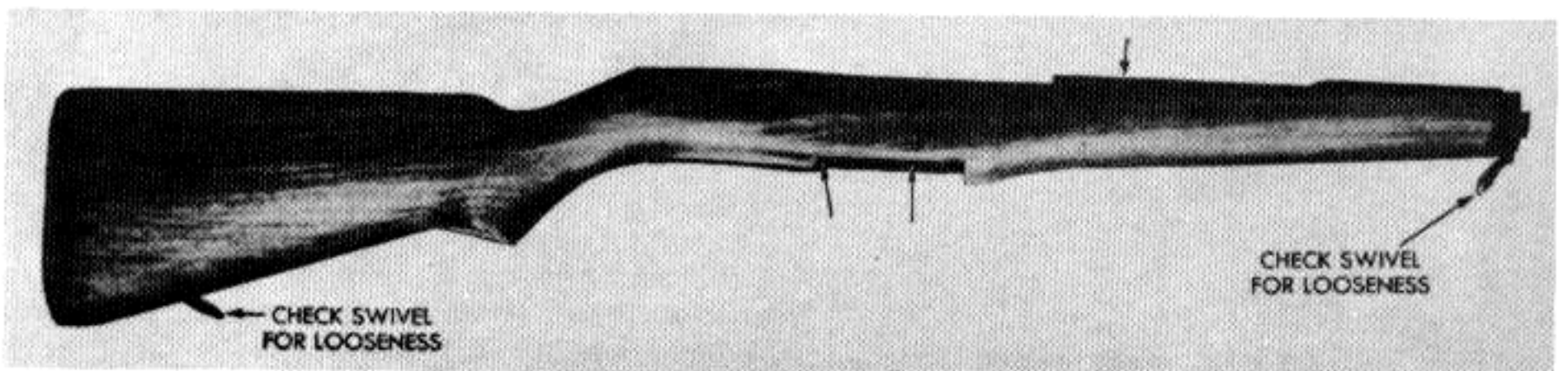

Fig. 155. Stock group, points to inspect (side view).

THE FIGHTING GARAND

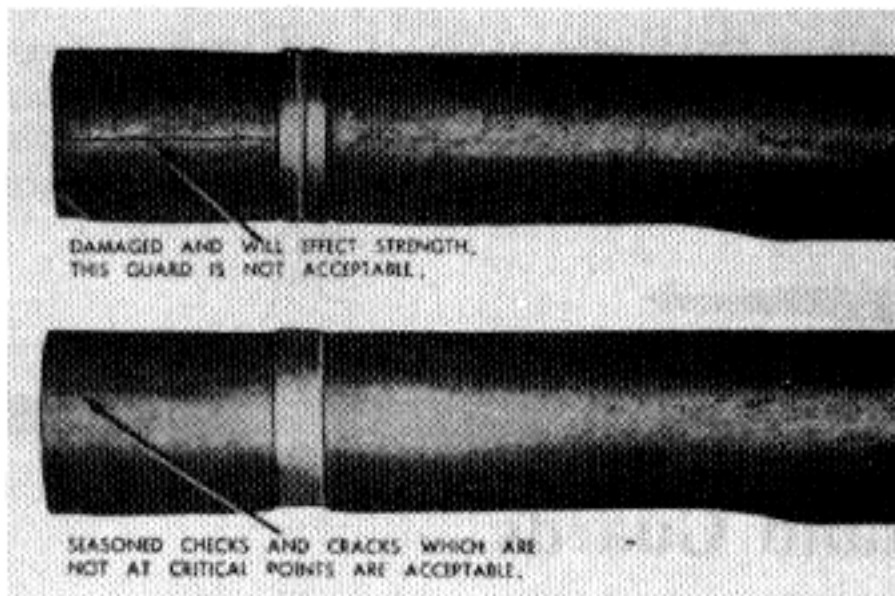

Fig. 156. Hand guards, defects.

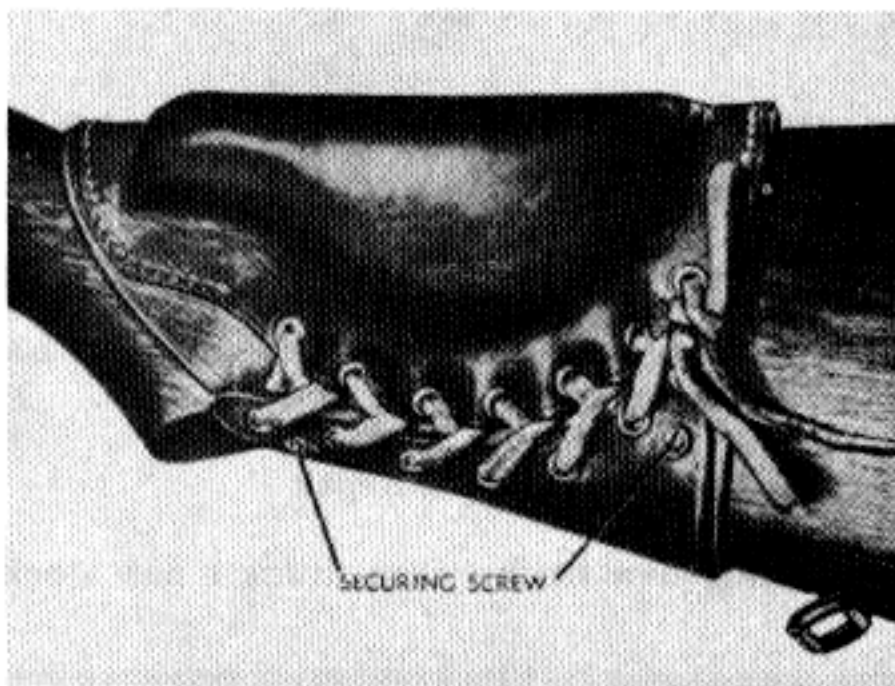

Fig. 157. Rifle stock with cheek pad.

(Figs. 154, 155), check to see that there is no binding or interference with operating parts. Stocks, although made of walnut and treated with linseed oil, sometimes swell, due to moisture, thus causing binding of the working parts. In such cases relieve the binding by using a flat file. Always file towards the sharp edges.

84. Dry wood: in dry climates the wooden parts of the rifle are apt to dry out and shrink. Occasional applications of raw linseed oil will help keep the wood in condition. Apply oil to the wood only, allowing it to remain a few hours to be absorbed, then wipe off excess with a clean cloth. Be careful not to allow linseed oil to get on metal parts, as it forms a gum when it dries, which will interfere with proper functioning of the parts.

85. Rear end of trigger group notch: insufficient clearance at this point will interfere with free trigger action. Remove the wood gradually until the trigger action is free.

86. Operating rod cut: binding at the operating rod cut may seriously interfere with the function of the rifle. Remove wood where necessary.

87. Operating rod binding on stock ferrule: when binding of the operating rod occurs at the lower band, remedy it by removing a small amount of metal from the stock ferrule. Before correcting,

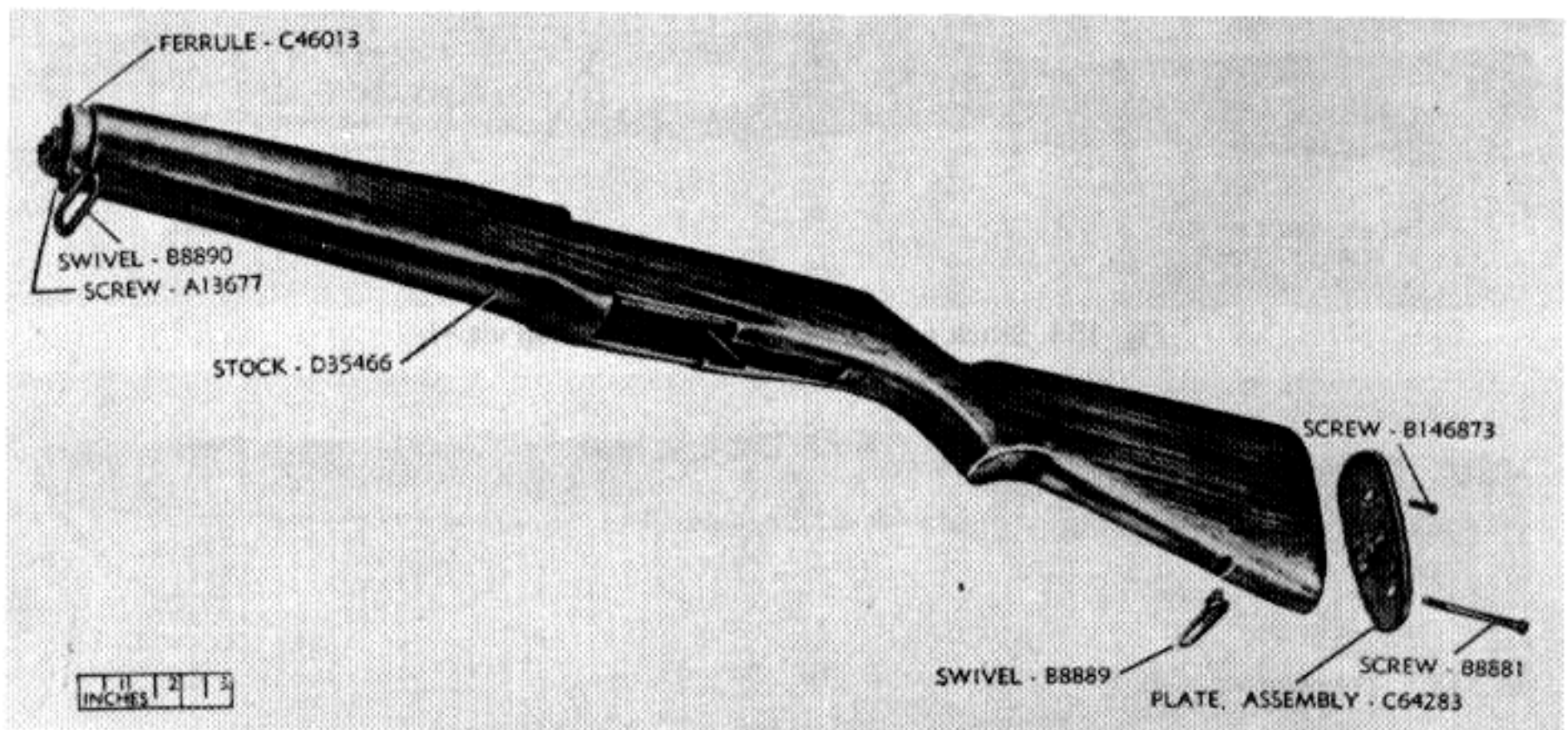

Fig. 158. Stock group parts.

THE FIGHTING GARAND

check the alignment of the lower band, and check the lower band pin for looseness.

88. Butt plate recessing: when fitting butt plate to a new stock, make certain it is seated properly to prevent danger of splintering or chipping at points where wood fails to meet the butt plate.

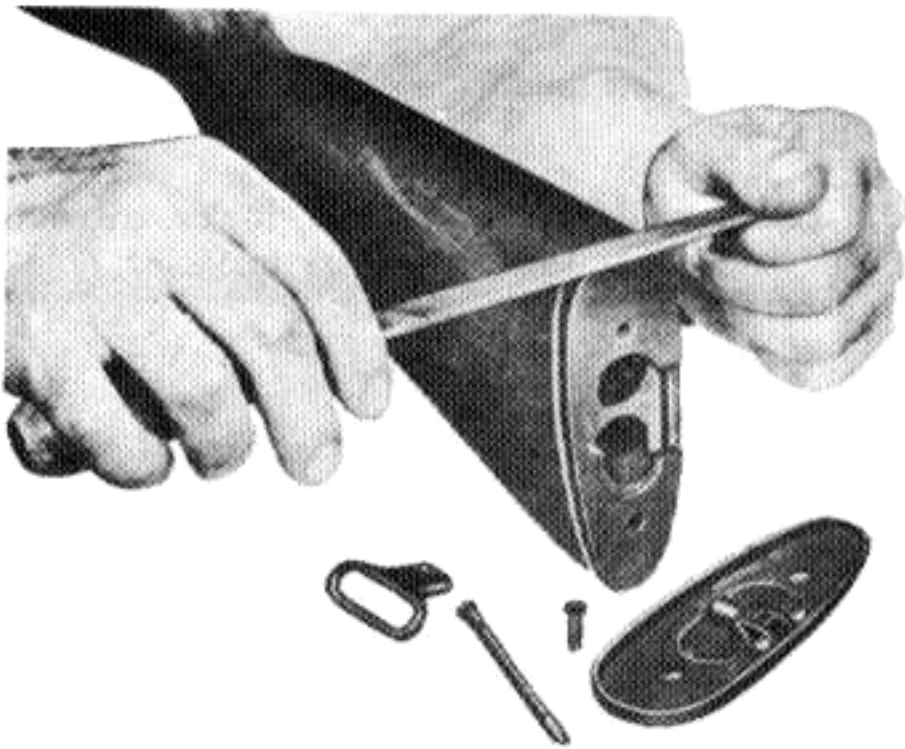

Fig. 159. Fitting butt plate on stock.

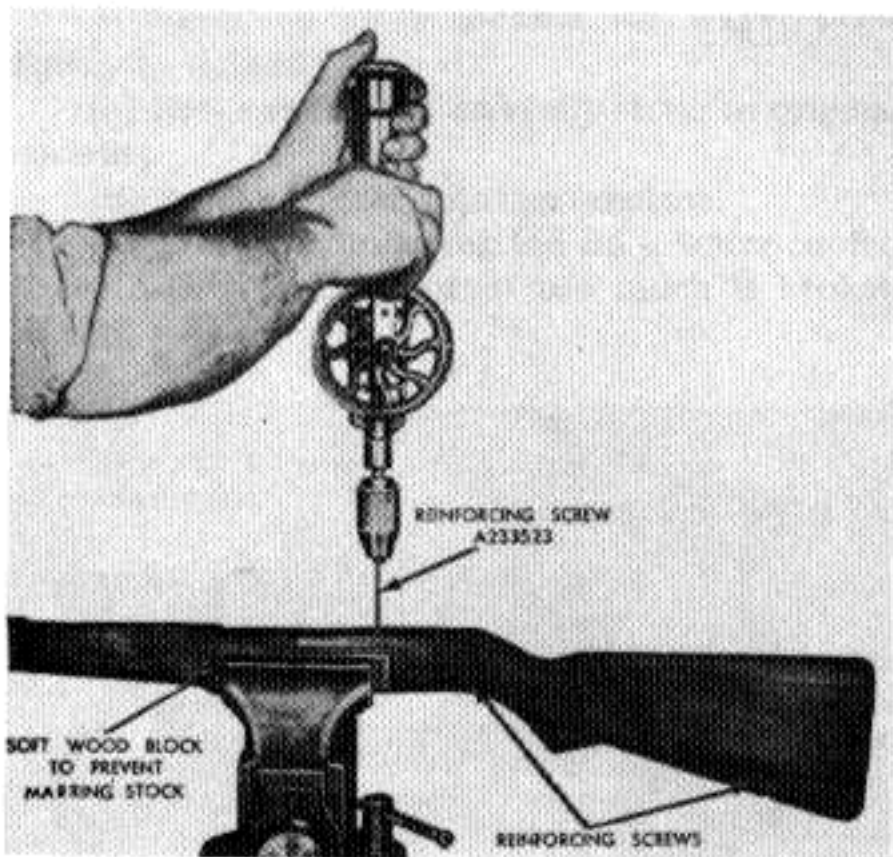

Fig. 160. Reinforcing patches on stock.

(a) Remove the plate by tapping it lightly to loosen it and then prying, being careful not to damage the butt. File the butt enough to seat the plate with a close fit all around. Fit it frequently while filing, to prevent removal of too much wood or of forming an uneven bearing. Use a medium

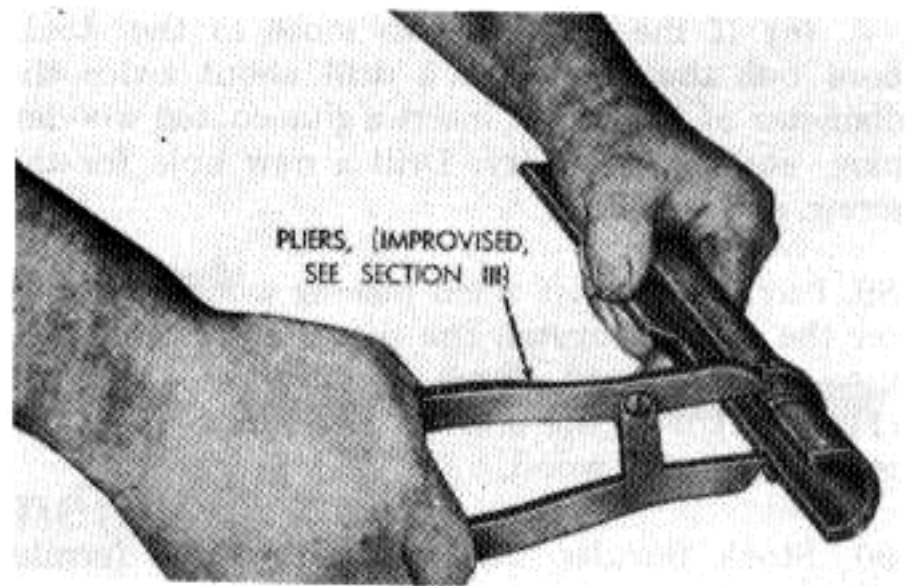

Fig. 161. Assembling and removing band.

fine, flat file (never coarse) and file evenly and smoothly, always filing the butt from heel to toe and stroking forward only. Put a slight chamfer on the sharp edges to prevent picking up splinters while filing (Fig. 159).

(b) Where wood protrudes beyond the butt plate, remove the wood until it is flush with the plate, using a fine, flat file. If necessary to remove wood from the top step of a new butt, use a file with a safe edge.

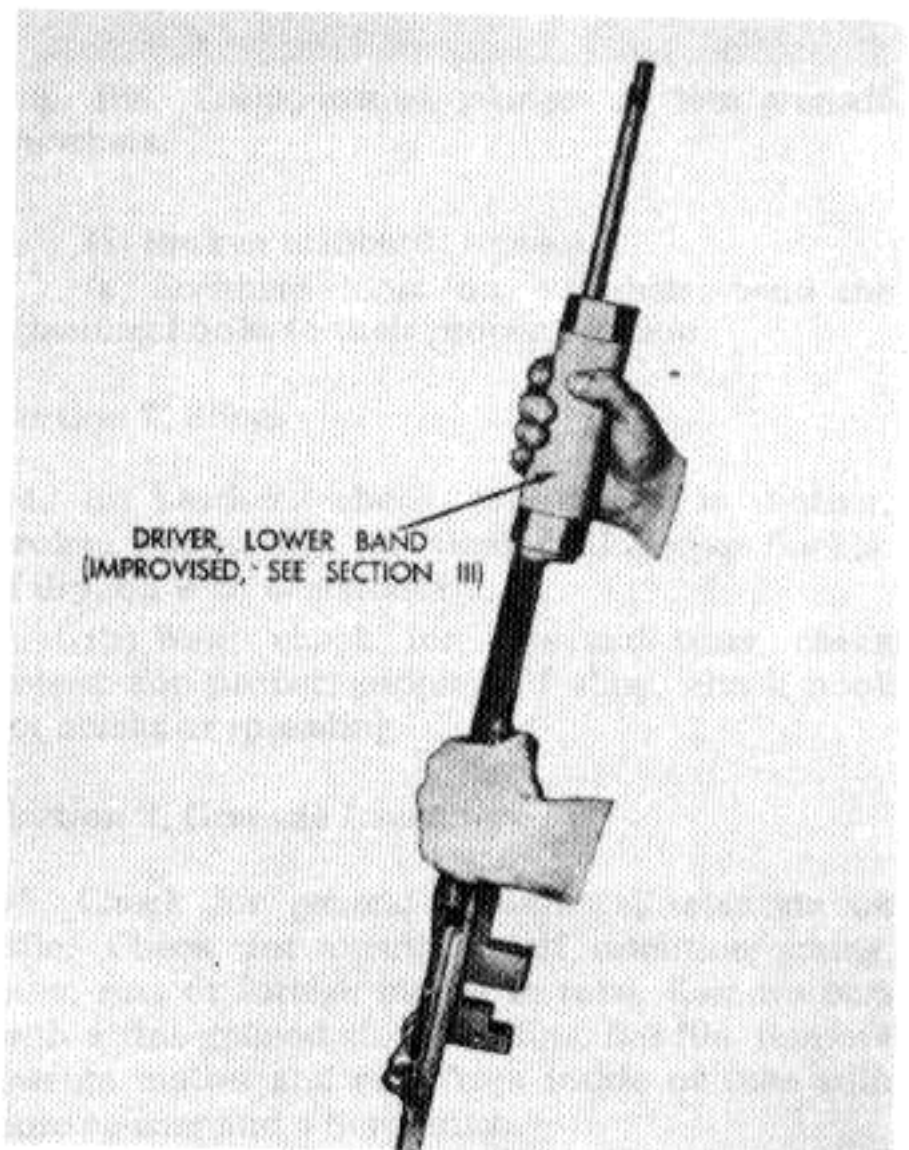

Fig. 162. Seating lower band on rifle, using band driver.

THE FIGHTING GARAND

(c) If the screw is too loose in the stock, bore out the hole with a drill about twice the diameter of the screw, insert a glue-coated wooden plug, and allow to dry. Drill a new hole for the screw, and install.

89. Patching stocks: when placing wooden patches on the stock, dovetail the pieces if possible, and use a brass wood screw to reinforce the patch (Fig. 160). File the end off the screw, so that it is flush with the wood.

90. Stock ferrules: the inside of stock ferrules (Fig. 158) are ribbed to insure firm grip on the wood. Do not remove ferrules unless they are unserviceable, as this will strip the mating ribs on the stock.

91. Hand guards: it is not necessary to replace a rear or front hand guard if it is serviceable and holds firmly in position. When replacing a front hand guard, shave the new guard to a tight fit into the ferrule of the lower band. Use improvised tool (Fig. 161) to seat the band. If the rear hand guard is loose, remove and spring the band together slightly using the improvised tool, and refit the guard. Restake a loose band pin, or replace and stake. If a front guard spacer is defective, replace hand guard.

92. Cheek pad (M1C and M1D), if dry, oil with neatsfoot oil. If there are tears in lacing holes, replace. If lacing is torn, replace.



XI. Equipment

Section 1, Bayonets

93. Bayonets should be thoroughly inspected for burs, broken or worn parts, and functioning. Fig. 163 shows the M1 bayonet disassembled. The M5 and M5-1 bayonets differ internally from the M1, but the following same points should be checked on all:

- (a) Broken grips: mend or replace.
- (b) Worn or loose locking lug ways:peen slightly to tighten.
- (c) Nicks and burs: carefully stone to original contours.
- (d) Broken or weak springs: replace.
- (e) Broken points: regrind on a water-cooled stone to original contour; if too much is broken off end, discard.

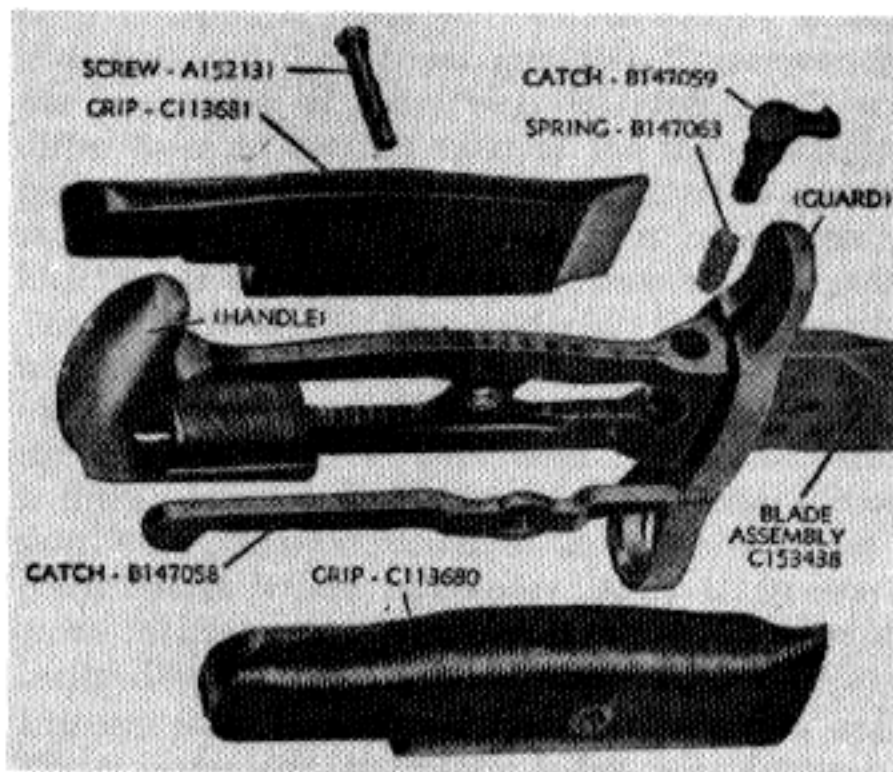

Fig. 163. M1 bayonet disassembled.

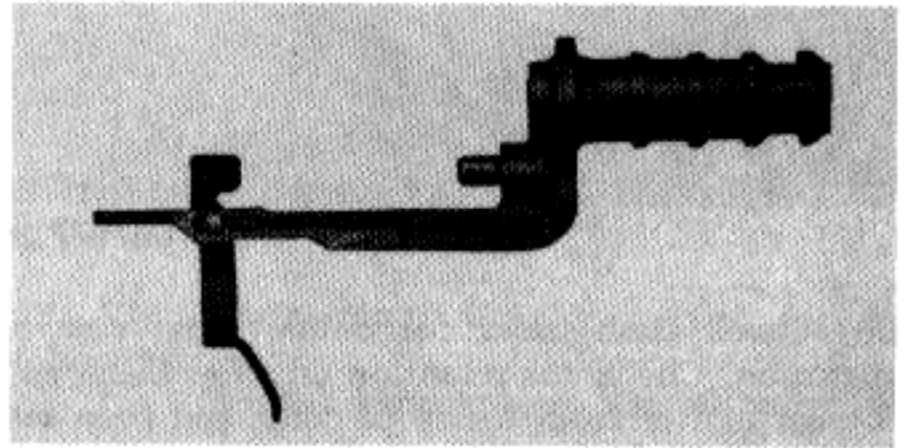

Fig. 164. Spring-loaded plunger of late grenade launchers.

- (f) Broken scabbard: replace.
- (g) Scabbard loose on web belt: bend the attaching hooks to their proper position.

Section 2, Slings

94. (a) Leather: check for cracks in leather, broken hooks, and functioning of keeper buckle. If dry, oil with neatsfoot oil.
- (b) Web: check for cuts and tears, check keeper for proper gripping of sling, check hook for cracks or spreading.

Section 3, Grenade Launchers

95. Check for general appearance, retention on rifle. Check for condition of retention spring, burs, rust or foreign matter in tube. Remove burs with a fine-grained stone, or fine, flat file. Remove foreign matter and rust from inside of tube with bore cleaner and a bore brush.

Section 4, Flash Hider

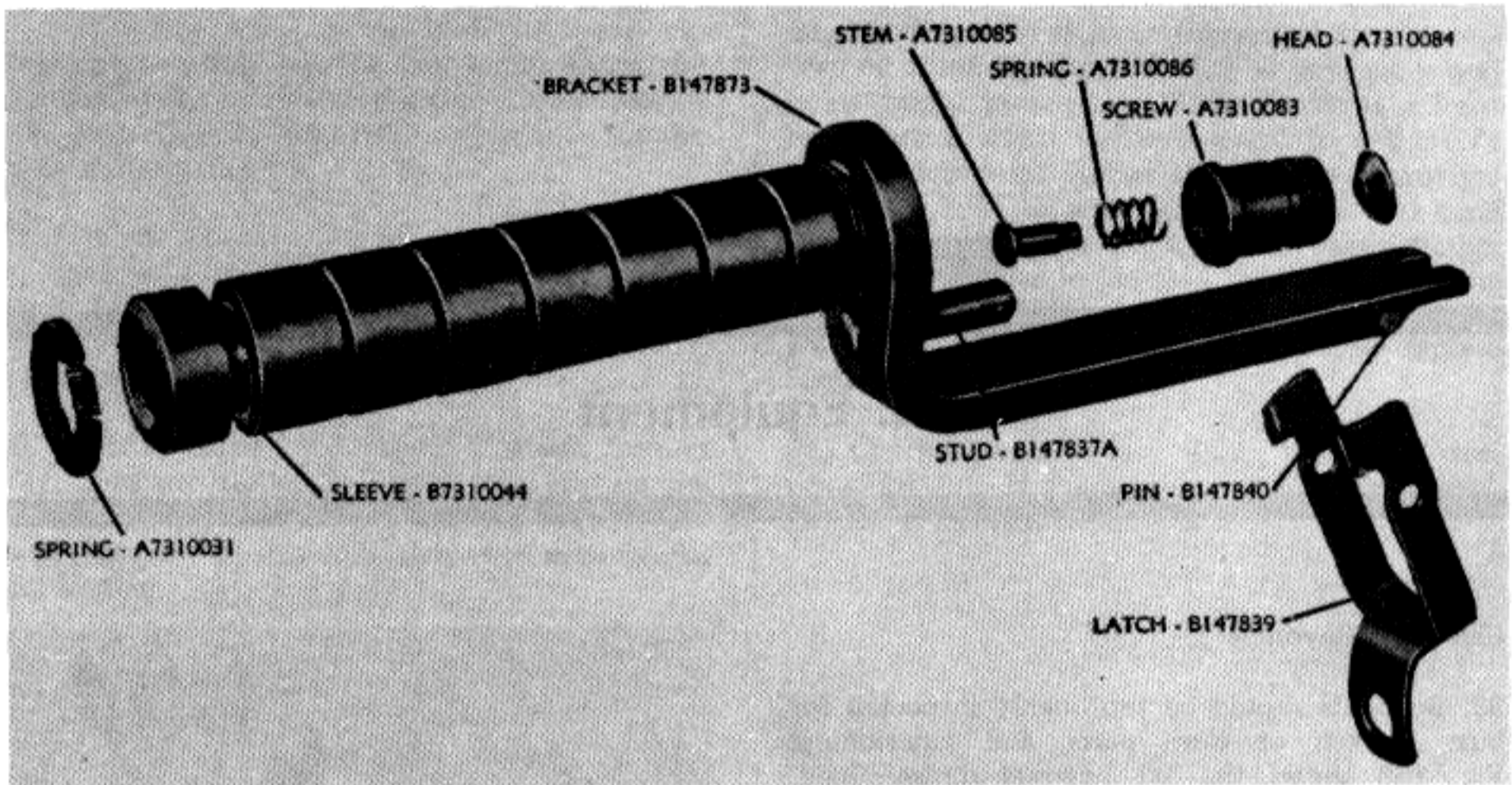

Fig. 165. M7 grenade launcher parts.

96. Check flash hider for dents, burs, rust or corrosion. Check for retention on rifle. Clean any foreign matter from inside of cone, and peen out

any dents. If badly dented, discard. Remove any burs with a fine-grained flat stone.



XII. Function Firing And Final Inspection

Section 1, Function Firing

97. Following complete rebuild, each weapon should be function fired using three full clips of standard service ammunition. Guns which fail to meet the function firing test should be inspected to determine the cause, and are corrected by such parts replacement or repairs as necessary. These guns are again subjected to a function firing test. After function firing, the rifles should be cleaned in the prescribed manner to prevent corrosion.

Section 2, Final Inspection

98. General: weapons brought in for repair may be assumed to have defects caused by use or neglect. When they were accepted as new weapons, the parts composing them were dimensionally correct and made of the proper material. Consequently, the inspection of these weapons after repair will differ from inspection used in the manufacturing plant, in that attention will be directed to wearing surfaces, parts that might crack or break due to high stress or fatigue, and evidence of corrosion. These defects do not evidence themselves by uniform reduction in a given dimension, but show up as a chipped edge, a partially worn surface, or an eccentric hole. A gage used in manufacturing is merely a means of comparing a known dimension with an unknown one to judge whether a piece comes within tolerances. After this piece is worn through use, the change in dimension is more easily detected in many cases by comparing with adjacent surfaces: the part itself becomes a gage. Visual inspection, therefore, is far more applicable in these cases and gaging is limited to those dimen-

sions that are critical or that may be more advantageously measured than compared. Inspection of non-critical parts (those which do not cause malfunctions) may be limited to appearance and the presence of cracks or flaws.

99. Visual inspection: visually inspect for the following:

- (a) General appearance, smoothness of operation, function of clip, latch and follower. Test with clip of dummy rounds.
- (b) Try cap of butt plate.
- (c) Inspect stock and hand guards for cracks or mutilation.
- (d) Be certain screws and swivels are staked properly.
- (e) Inspect gas cylinder and lock for burs.
- (f) Inspect front sight for looseness and bent or burred wings.
- (g) Inspect rear sight for:
 - (1) Binding of windage.
 - (2) Elevation, looseness, and sharpness of clicks.
- (h) Inspect trigger housing group for:
 - (1) Bent trigger guard.
 - (2) Burs on lugs that lock trigger group to receiver.
 - (3) Worn locking notch on trigger guard.
 - (4) Tension of clip ejector.
 - (5) Function of safety, trigger, sear, and hammer.

100. Test the following with appropriate gages, referring to the serviceability chart for tolerances:

- (a) Trigger pull.
- (b) Firing pin protrusion.

THE FIGHTING GARAND

(c) Headspace.

(d) Inspect bore and chamber.

(e) Assemble and function test with dummy cartridges.

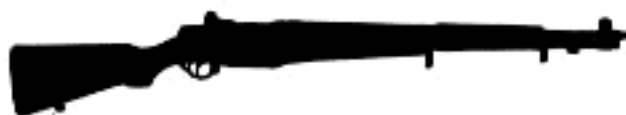

XIII. Modified Garands

Section 1, The BM-59 Series

101. The BM-59 series of modified Garand rifles were designed and are constructed by Fabbrica D' Armi Pietro Beretta S.P.A., Brescia, Italy. They are an inexpensive, good quality modernization of the Garand rifle, bringing it more into line with the current demands for a semi-automatic or fully-automatic infantry weapon. The BM-59 conversion has been offered to various NATO countries already armed with the Garand M1 rifles, for \$42 complete, on existing Garands. The following alterations are made on the basic Garand:

(a) New, lighter barrel fitted, in caliber 7.62mm NATO, compensator.

(b) Modification of the receiver to accept three standard magazines, and stripper clip guide installed on the receiver, to allow the use of stripper clips if desired. Automatic bolt hold-open installed.

(c) Modification of the operating rod and spring, to adapt them to the new barrel and magazine.

(d) Fitting of a new type (stainless steel also, as original) gas cylinder.

(e) Modification of the trigger housing to permit use of box magazine.

(f) Manufacture and installation of fully automatic fire mechanism.

(g) Modification of the stock and other non-mechanical components to allow for insertion of new mechanical features (magazine, selective fire mechanism, etc.)

(h) Fitting of selector lever for selective fire.

102. There are six models of the basic BM-59 modifications.

(a) Mark I (Fig. 166), the basic model of the series. Uses 20-round detachable box magazine, is selective fire.

(b) Mark II (Fig. 167), similar to Mark I, but with full pistol grip, a lightweight bipod, winter trigger, and hinged butt plate.

(c) Mark III (Fig. 168), similar to Mark I, but with full pistol grip, folding steel butt (designed for the launching of grenades), bipod.

(d) Mark IV (Fig. 169), intended as a replace-

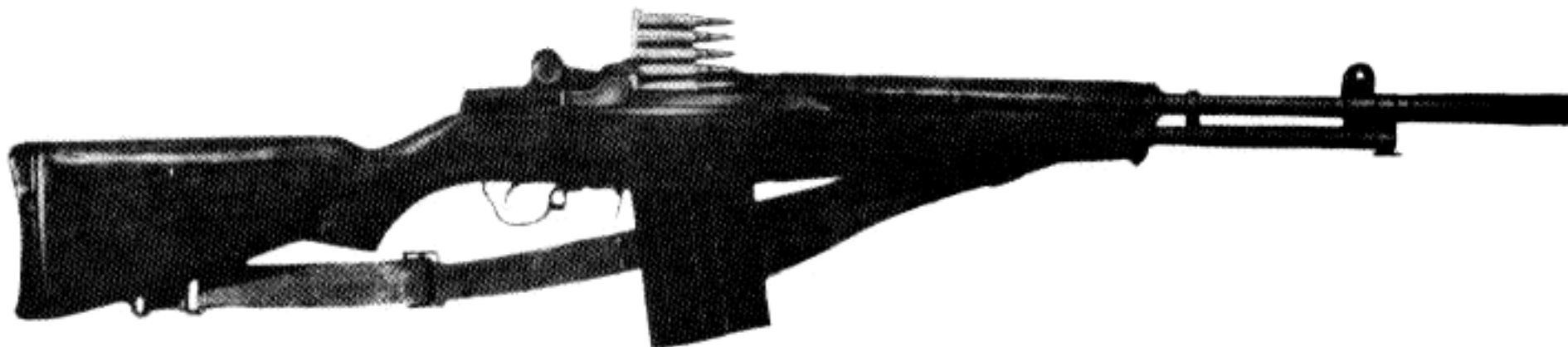

Fig. 166. BM-59 Mark I, basic rifle of the BM-59 series.

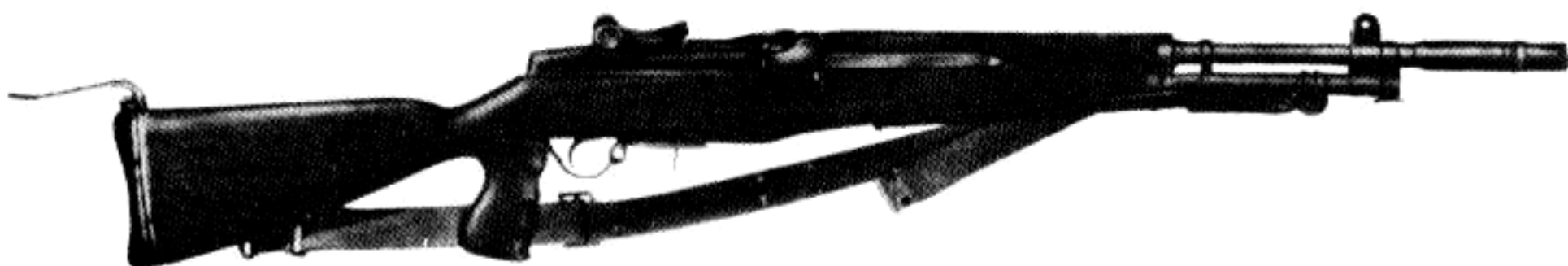

Fig. 167. BM-59 Mark II (note pistol grip, butt plate, bipods).

ment for the BAR, similar to Mark II, but with heavier bipods, flash hider, etc.

(e) Mark ITAL (Fig. 170), similar to Mark I, but with grenade launcher installed as part of the compensator, bipod, hinged butt plate, and lug for .30 U.S. Carbine bayonet.

(f) Mark ITAL-A (Fig. 170), similar to Mark III, but with a special detachable grenade-launcher, and lug for .30 U.S. Carbine bayonet.

103. The following accessories are available for the various models of the BM-59 series:

- (a) Bipods.
- (b) Hinged butt plate.
- (c) "Mecar" type grenade launcher.
- (d) Incorporated (part of compensator) grenade launcher.
- (e) Winter trigger.
- (f) Blank firing attachment.
- (g) Full-automatic fire cutoff.
- (h) 20-round detachable magazines.
- (i) Sling.

104. To load and fire the BM-59 rifles you:

(a) Insert 20-round box magazine into bottom of receiver until it latches.

(b) Pull operating rod handle all the way to the rear, and release it. This chambers a round, and the rifle is ready to fire.

(c) The safety functions as on the Garand M1.

(d) The magazine may be reloaded while in the rifle by inserting stripper clips of ammo from the top, using the clip guide on the receiver.

(e) The bolt stays open after the last shot.

(f) Sight adjustment is as on the Garand M1.

105. To strip the BM-59 rifles into the three main groups you:

(a) Cock rifle, put safety in locked (forward) position.

(b) Remove trigger housing group from rifle, as on Garand M1.

(c) Lift stock from barrel and receiver group, as on Garand M1.

106. The basic BM-59 Mark I:

(a) Is 40.5 inches long.

(b) Has a barrel length of 17.4 inches.

(c) Has a compensator 5 inches long.

(d) Has four groove rifling, right hand twist, one turn in 11.9 inches.

(e) Weighs 8.7 pounds without magazine.

(f) Has a cyclic rate of fire of 780-840 rounds per minute.

(g) Has a sighting radius of 21 inches.

107. A somewhat different "BM-59" modified Garand was made in the U.S. under license from Beretta in the 1960's and was for sale on the commercial market. It was semi-auto only, and did not

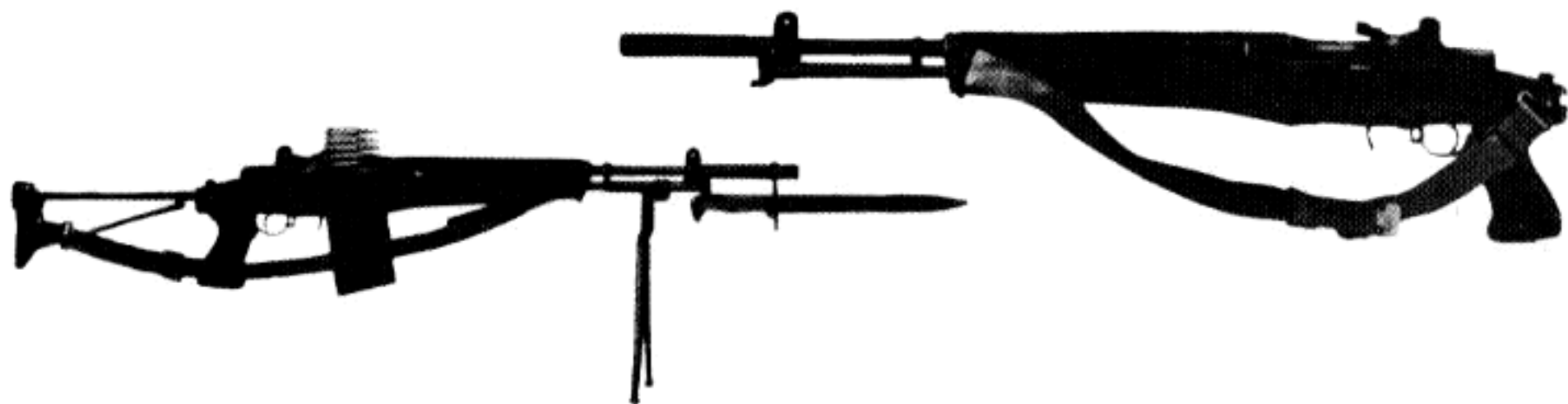

Fig. 168. BM-59 Mark III (note folding stock, pistol grip, bipods).



Fig. 169. BM-59 Mark IV (note pistol grip, butt plate, heavy bipods).

have as many new components as the original BM-59 conversion. It used the standard BM-59 magazine and was chambered in 7.62mm NATO. The outward appearance was generally similar to the original BM-59, although the original gas cylinder and butt plate of the Garand were retained and there was, of course, no selective fire lever. This particular model was manufactured by

Golden State Arms Corp., which was noted for its many conversions of surplus military rifles into sporters. During the early 1980's, Springfield Armory purchased all the original remaining BM-59 parts which remained in the Beretta inventory and began assembling them into finished semi-auto rifles in the U.S. These rifles proved popular with sportsmen and para-military enthusiasts alike.

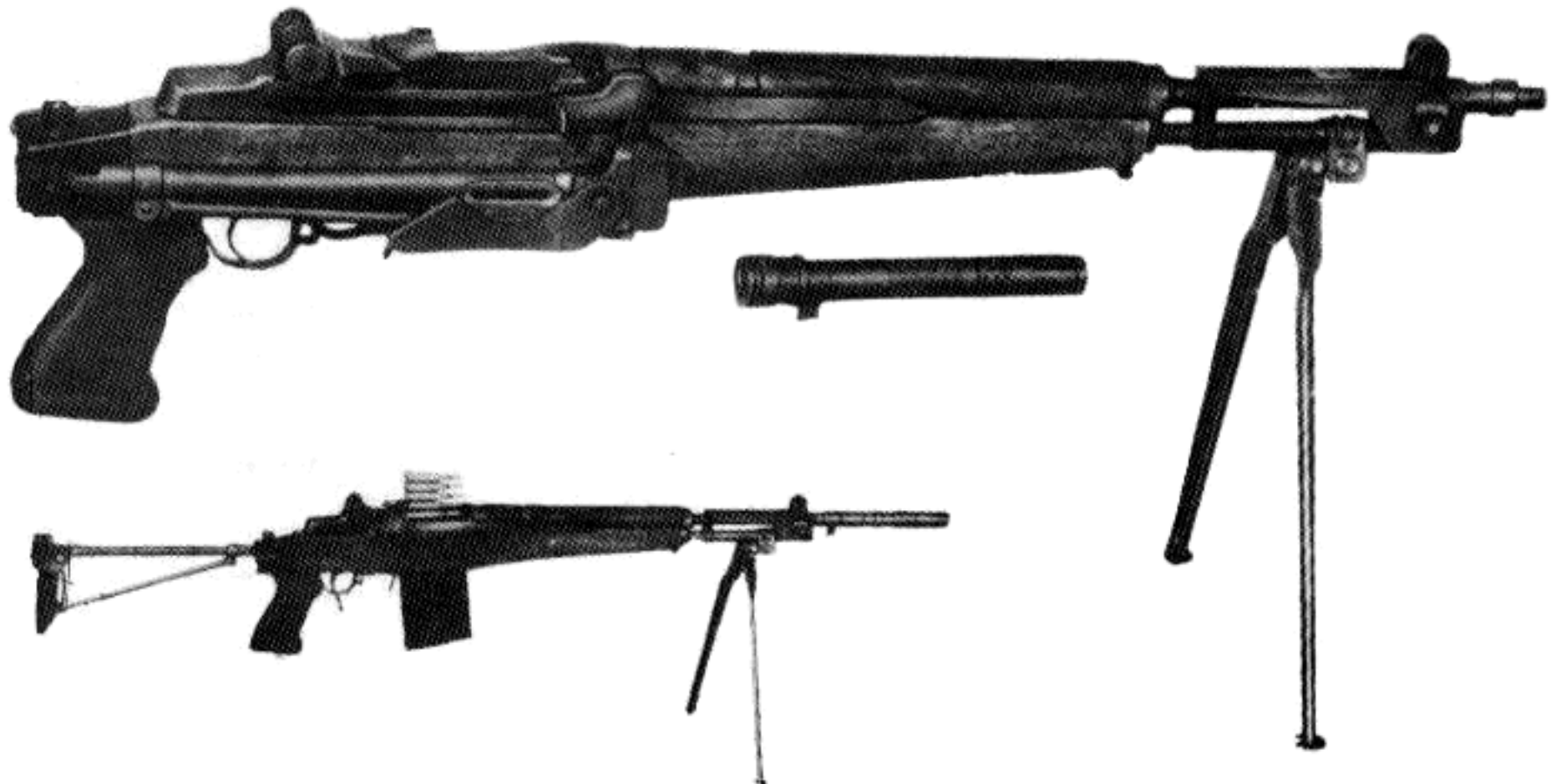

Fig. 170. BM-59 Mark ITAL-A (note folding stock, grenade launcher and grenade launcher sights, folding bipod) Mark KTAL similar, but full stocked.

THE FIGHTING GARAND



Fig. 171. M14 "Garand".

Section 2, The "M2" or "M14 Garand"

108. The "M2" or "M14 Garand" as it was variously called, was a minimum but effective conversion of the Garand M1 rifle to a more modern configuration. Manufactured in the U.S., it was for sale on the commercial market during the 1960's. It was a semi-auto only model, as the original Garand trigger housing was not altered in any way except to accept the standard 20-shot M14 7.62mm military magazine.

109. The "M2" has the following specifications:

- (a) Caliber 7.62mm NATO (.308 Winchester).
- (b) Barrel length 17 1/4", with flash suppressor 21".
- (c) Weight 8 1/2 pounds empty.
- (d) Sights, same as original Garand M1.
- (e) Cartridge capacity 20 rounds (standard M14 magazine).
- (f) "Winter" safety for ease in locking.
- (g) Bolt remains open after last shot.
- (h) No provisions for stripper clip feeding.
- (i) It will accept the current M5-1 bayonet for the Garand M1.

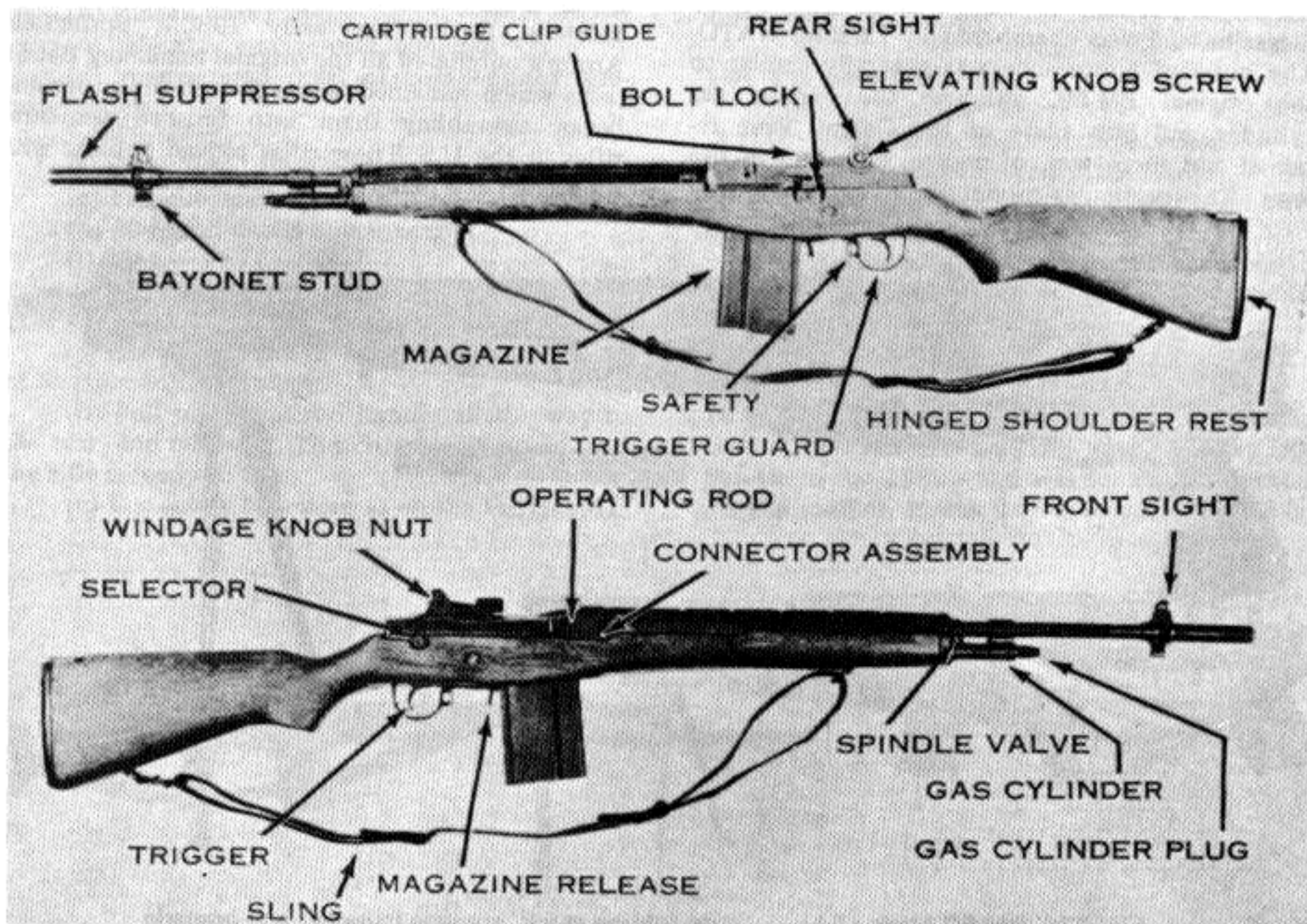

Fig. 172. U.S. rifle 7.62mm M14.

THE FIGHTING GARAND

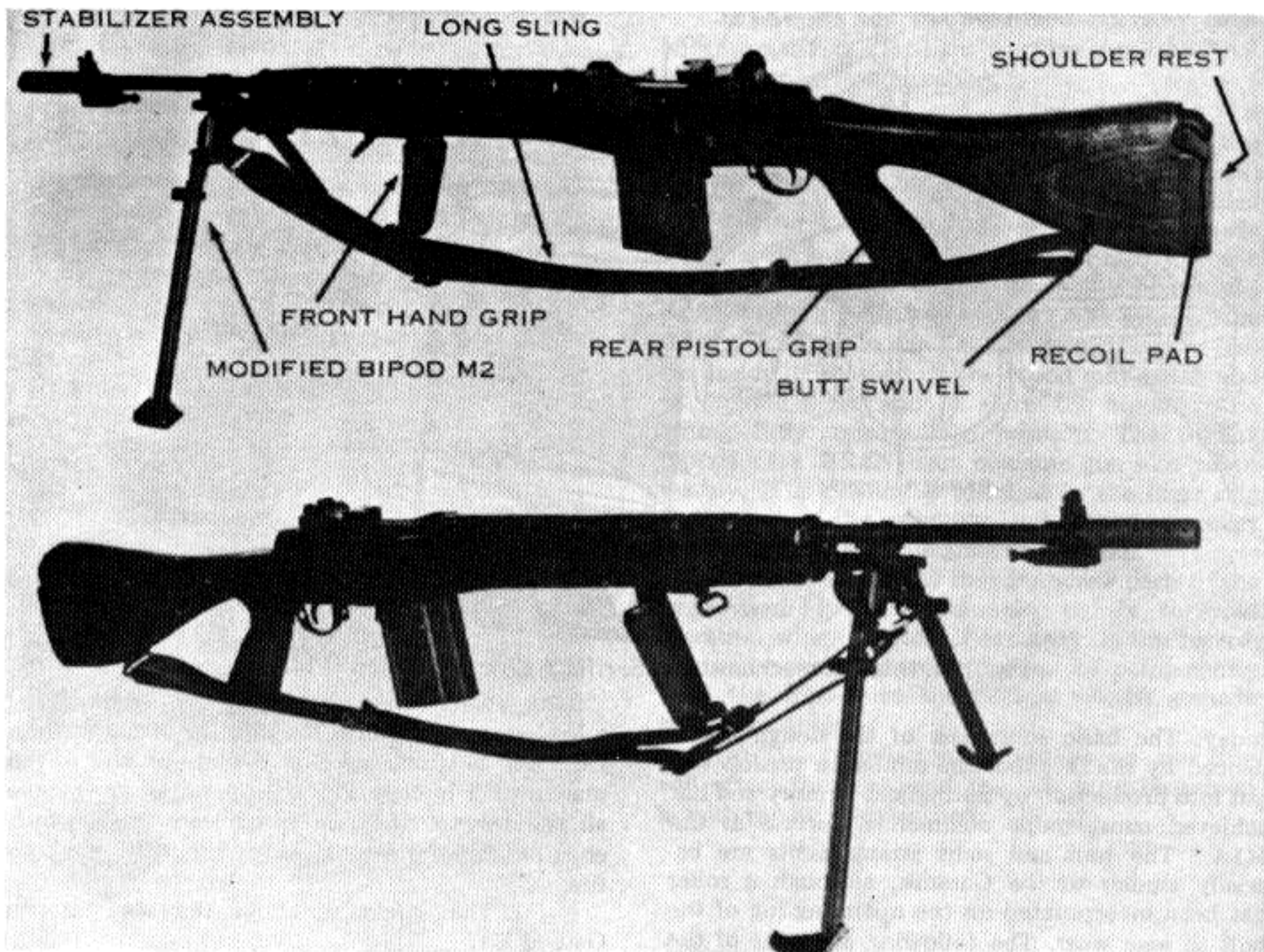

Fig. 173. U.S. rifle 7.62mm M14E2.

110. To load and fire the "M2":

(a) Insert a loaded magazine into the bottom of the receiver toe first, and rock upward and to the rear until it latches.

(b) Pull the operating rod handle all the way to the rear and release it, which chambers a round and makes the rifle ready to fire. The safety, although slightly modified, functions the same as the Garand M1.

(c) To unload the "M2", push forward on the magazine catch in front of the trigger guard, and remove the magazine from the receiver. Pull the operating rod handle all the way to the rear to extract and eject the round in the chamber.

111. To strip the "M2" into its three main groups:

(a) Remove the trigger housing as on the Garand M1.

(b) Remove the barrel and receiver and assembly from the stock group.

(c) Further detail stripping of the "M2" is the same as for the Garand M1, excepting the operating rod spring and follower and other parts modified or left out in converting the Garand.

Section 3, U.S. Rifles 7.62mm, M14 & M14E2

112. Although not a modification of the Garand rifles in a strict sense, the M14 rifle is a direct outgrowth of the experiments made toward the end of WW II aimed at modernizing the Garand with a detachable box magazine and selective fire features. A brief description of the M14 is included herewith as a matter of interest.

113. Although it caught the brunt of much commercial abuse from persons trying to sell the government various other new rifles and was ultimately replaced by the M16, the M14 is still one of the outstanding military rifles in existence

THE FIGHTING GARAND

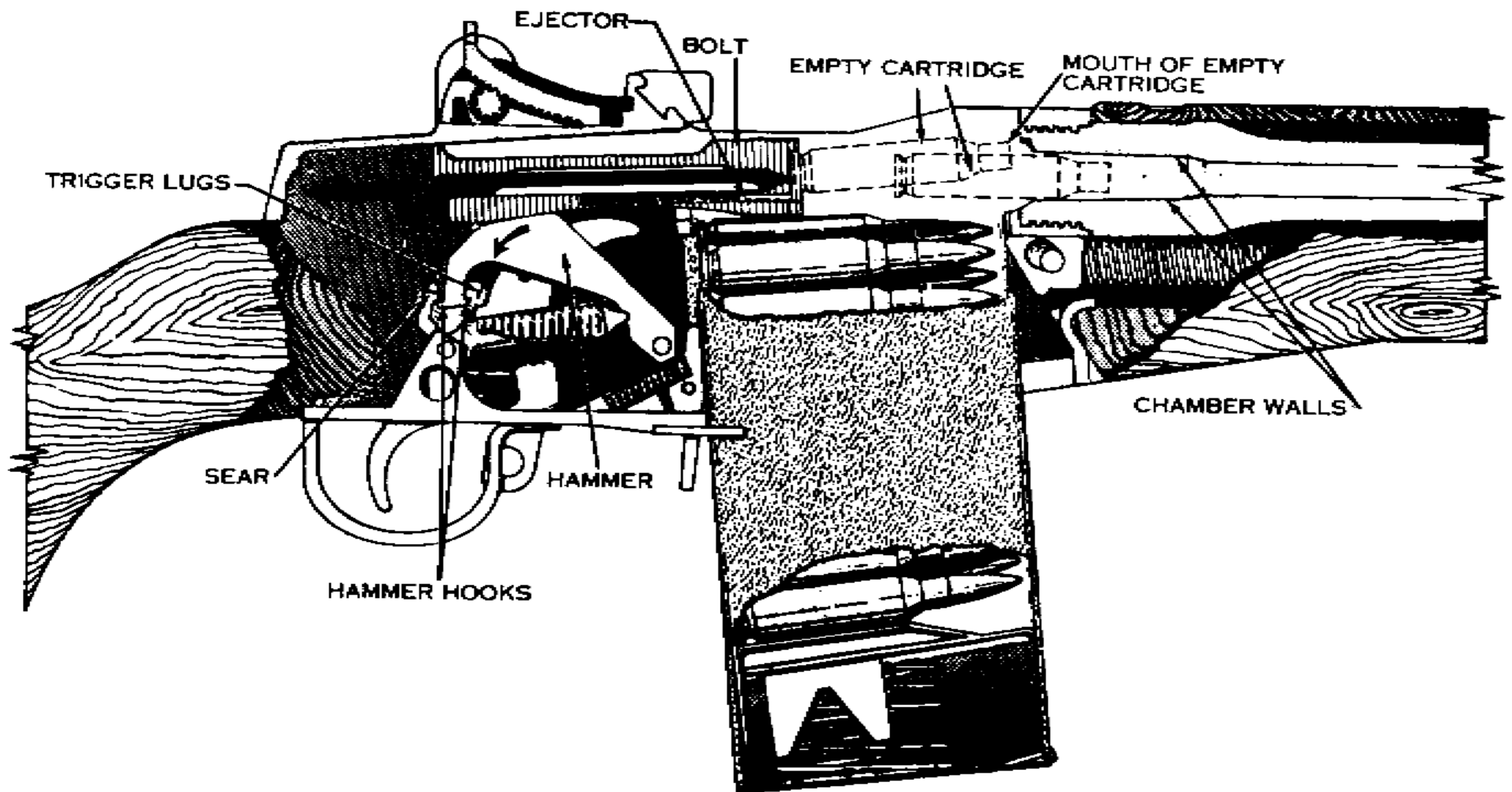

Fig. 174. Internal mechanism, U.S. rifle 7.62mm M14 and M14E2.

today. The basic soundness of the design is evidenced by the fact that the semi-auto version was put into production by Springfield Armory and has achieved considerable commercial success as the M1A. The bolt and sight arrangements are basically similar to the Garands, although a roller has been incorporated on the operating lug of the bolt to ease wear. The following are some of the improvements over the excellent Garand which have been incorporated in the M14:

- (a) 20-round detachable box magazine.
- (b) Flip-up butt plate.
- (c) Flash suppressor at muzzle.
- (d) Improved "short-stroke" gas system (similar to .30 M1 Carbine).
- (e) Selective fire option (selector lever not installed on M14).

114. Characteristics:

- (a) Weight with full magazine and cleaning equipment, 11 1/4 pounds.
- (b) Weight of M14E2 with full magazine, 14 1/2 pounds.
- (c) Length, overall 44 1/8 inches.
- (d) Muzzle velocity, 2,800 f.p.s.
- (e) Cyclic rate of fire, 700-750 rounds per minute.
- (f) Trigger pull, 5.5 to 7.5 pounds.

115. To load and fire the M14 or M14E2, insert

a loaded magazine into the receiver of the weapon from the bottom, toe first. Rotate up and to the rear until it latches. Pull the operating rod handle all the way to the rear and release same, which chambers a round and makes the rifle ready to fire.

(a) The safety functions the same as the Garand M1.

(b) To unload the M14 or M14E2, press forward on the magazine catch in front of the trigger guard. Remove the magazine downward from the receiver, and pull the operating rod handle to the rear to extract and eject the round in the chamber. If the bolt is desired to be kept in the rearward position with no magazine in the rifle, push in on the bolt stop on the left side of the rifle, when the bolt is in the rearward position, and the bolt will stay back.

(c) The bolt stays open after the last shot has been fired, and the rifle may then be reloaded with a fresh magazine, or with stripper clips of ammunition from the top, using the stripper clip guides. To let the bolt go forward, pull back slightly on the operating rod handle and release it.

Section 4, Improvised Bipod for Garand

116. As a means of steadying the rifle when making long-range shots, a folding bipod is often

THE FIGHTING GARAND

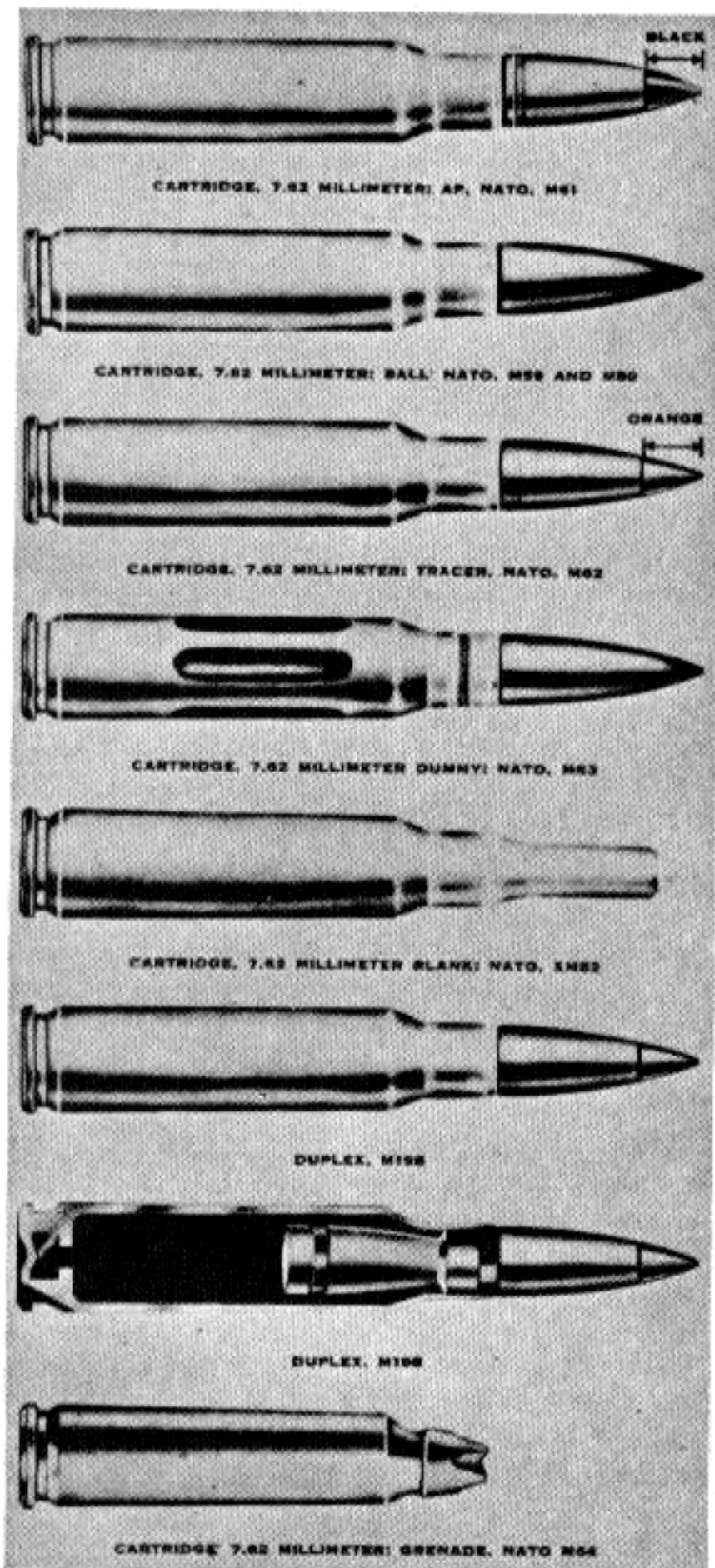

Fig. 175. 7.62mm NATO ammunition suitable for Garand modifications.

a useful accessory, especially when "varmint" hunting or doing close target work.

117. An effective bipod attachment may be made in the following manner:

(a) Secure an M7A1, M7A2, or M7A3 grenade launcher, and cut the tube off, approximately 3/4 inch from the base, leaving a projection.

(b) Secure the folding bipod assembly from an automatic rifle or light machine gun (the BAR is the most easily adaptable).

(c) Thread the end of the remaining projection on the grenade launcher, and tap the rear end of the flash-hider (if a BAR bipod is used) to match. The bipod assembly is easily installed on the rifle in the same manner a regular grenade launcher is, and the bipods will fold nearly all the way up for carrying attached. If it is considered desirable to have the bipods attached most of the time, the wood on the handguard of the rifle, and the inside of the feet of the bipod may be altered to provide a fit, and to allow the bipods to be swung fully upward into position. The folding bipods of a BREN light machine gun also adapt readily, if a bushing is installed in the large ring at the top of the assembly, and tapped to accept the threaded end of the grenade launcher.

(d) It is important that the screw parts of the improvised bipods be assembled tightly, to avoid vibration which will affect accuracy. In this regard, it may be found more expedient to permanently weld the bipods to the bottom of the grenade launcher nubbin.

(e) The installation of bipods on the rifle will affect the zero, and the rifle must be zeroed in with the bipods attached.